

20 Linear Direct/Indirect Suspended



inter•lux



Contents

- 1 overview
- 2 specifications / configurator
- 3 photometry



Miniature suspended Direct, Indirect or Direct / Indirect for general, accent and decorative lighting. Power suspensions with small ceiling canopies and continuous rows.

QS Quick Ship Available

- Suspended fixture with minimal housing for continuous mounting to any desired length (1/4" increments).
- Multiple lenses for general, accent, decorative and grazing application.
- Extruded aluminum housing, easily installed. Field maintainable and upgradeable LED and driver without upsetting the ceiling.
- Efficacy up to 80 (Direct) | 94 (Indirect) lumens per watt (delivered) @ 3000K, see photometry page for details.
- 90+ CRI, 3 Step MacAdam (Static White).
- L70 (TM21 Projected 85°C) Static White 60,000 hours, Warm Dim 36,000 hours.
- ETL and ETL-C for dry and damp locations.
- Lengths and angles factory-cut to exact field dimensions. Standard and custom corners.
- Powdercoat painted.

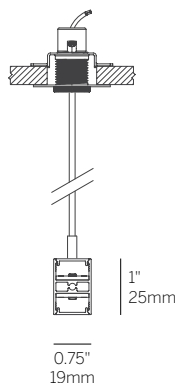

Gypsum / Tile Ceiling

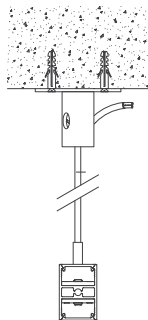

Solid Ceiling

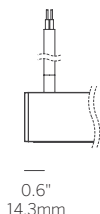

Power Feed

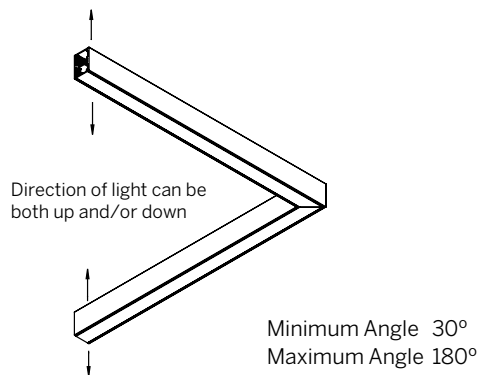

Pattern Corner

Ordering Information

Model	Fixation	Pattern	Length	Direct				Indirect				Finish	Options
				Power ²	CRI/CCT ³	Driver ⁴	Lens	Power ²	CRI/CCT ³	Driver ⁴	Lens		
WG-20LDI direct/indirect	S48 (std) S96	S P ¹ PZ ¹	A A x B A x B x C A x B x A x B	L M H	927 930 935 940 WD	X S D010 DPH L3DAE L3DOE EL96 DALI	OD (std) MPL NL16 BDO ⁵ BDC ⁵ ROD ⁵	L M H	927 930 935 940 WD	X S D010 DPH L3DAE L3DOE EL96 DALI	OD (std) SD	W (std) B S F	AWNRF BT 5C DC EM

Model

- WG-20LDI = 20 Linear Direct/Indirect Suspended
- WG-20LD = 20 Linear Direct Suspended
- WG-20LI = 20 Linear Indirect Suspended

Fixation

- S48 = 48" suspension cable standard, field-cuttable (standard)
- S96 = 96" suspension cable, field-cuttable

Pattern

- S = Straight run (continuous runs of any length available in 0.25" increments) (above 60" additional suspension points)
- P = Standard patterns 2, 3 or 4 sided with 90° corners on the same plane¹
- PZ = Non-standard patterns and/or corners other than 90° on multiple planes, consult factory¹

Length

- A x B x C = specify inches to the nearest 0.25" (i.e. 72.25")
For patterns specify each length (i.e. 2 sided: A x B = 72.25" x 48";
3 sided: A x B x C; 4 sided: A x B x A x B)

Power²

- L = 3W/ft low power (WD 2.7 W/ft) (24V)
- M = 6W/ft mid power (WD 5.5 W/ft) (24V)
- H = 10W/ft high power (WD 8 W/ft) (24V)

CRI / CCT (90+ CRI minimum)³

- 927 = 2700K
- 930 = 3000K
- 935 = 3500K
- 940 = 4000K
- WD = Warm Dimming (1800K - 3000K)

Driver (remote)⁴

- X = No driver, ordered separately
- S = Standard, non-dim driver 120-277V
- D010 = eldoLED, 10%, 0-10V dimming, 120-277V
- DPH = Phase Dimming, 1% dimming, 120V only
- L3DAE = Lutron Hi-lume 1% EcoSystem, 120-277V
- L3DOE = Lutron Hi-lume Premier 0.1% EcoSystem, 120-277V
- EL96 = eldoLED, 24V, 0.1% 0-10V Dimming
- DALI = eldoLED DALI (DT6), 0.1% dimming (120-277V)

Lens

- OD = Satin opal diffuser (standard)
- SD = Satin clear diffuser
- MPL = Micro-prismatic lens
- NL16 = Linear narrow lens, 16°
- BDO = Block Diffuser Opal⁵
- BDC = Block Diffuser Clear⁵
- ROD = Round opal diffuser⁵

Finish

- W = White, 15% gloss, RAL 9010 (standard)
- B = Black, 15% gloss, RAL 9005
- S = Silver, 15% gloss, RAL 9006
- F = Custom finished trim, specify RAL

Options

- AWNRF = Lutron Athena Wireless Node RF (specify with D010, EL96, or DALI)
- BT = Wireless CAS – Casambi (specify with D010, EL96, or DALI)
- 5C = 5" canopy (use with 4" Jbox)
- DC = Dual circuit
- EM = Emergency (remote)

- 1 See pattern spec sheet.
- 2 Wattage is shown for LED boards only, system wattage varies depending on driver selected. Maximum combined wattage for Direct + Indirect shall not exceed 13 W/ft.
- 3 When specifying 20LDI please specify CRI / CCT and Driver for Direct and Indirect if different CRI / CCT / Driver is needed, i.e. 930-M-OD-D010-RGBW-M-SD-DMX. See photometric data sheet for delivered lumens.
- 4 Remote power supply required. See power supply page for details.
- 5 Butt seam (lens) when in continuous run, straight runs only.

Lenses/Accessories



Opal Diffuser (OD)
Satin Diffuser (SD)
Micro-prismatic Lens (MPL)



Narrow Lens (NL16)



Block Diffuser (BD)



Round Opal Diffuser (ROD)

20 Linear Direct/Indirect Suspended

DIRECT / INDIRECT

WG-20LDI-...-M-...-OD-M-...-SD
Delivered Lumens Per Foot

		Power			
		L [3 W/ft]	M [6 W/ft]	H [10 W/ft]	RGBW [7.6 W/ft]
CCT	927	419	838	-	-
	930	456	911	-	-
	935	540	1082	-	-
	940	643	1285	-	-
	WD ²	160	333	482	-
	RGBW ³	-	-	-	272
UGR ⁴		24.3	26.8	-	-

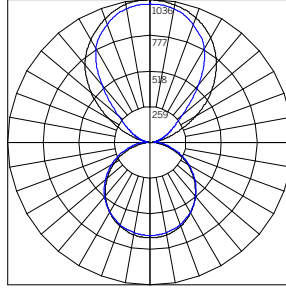

BEAM ANGLE (0-180) = 82.8
BEAM ANGLE (90-270) = 106.8

ILLUMINANCE - 48" OD/SD M 3500
WG-20LDI-...-S-48-M-935-...-OD-M-935-...-SD-W¹

Mounting Height [ft]	Illuminance [fc at max cd]	Beam Width [ft]
2	259	3.5
4	65	7.1
6	29	10.6
8	16	14.1
10	10	17.6
12	7	21.2
14	5	24.7
16	4	28.2
18	3	31.7
20	3	35.3

Power Multiplier				
	L [3 W/ft]	M [6 W/ft]	H [10 W/ft]	RGBW [7.6 W/ft]
9XX/RGBW	0.5	1.00	-	-
WD	0.30	0.62	-	-

CCT Multiplier				
	927	930	935	940
	0.77	0.84	1.00	1.19

- 1 Polar Plot and Cone of Light are applicable to part number noted; use Multiplication Factor table to approximate other models or refer to online photometry.
- 2 WD lumen data at maximum output (3000K).
- 3 RGBW lumen data at maximum output with 3000K White LED.
- 4 UGR value noted is the maximum UGR (crosswise) with 935 LEDs / 48" length.

DIRECT

WG-20LD-...-OD-X-XXX-X-XX-W
Delivered Lumens Per Foot

		Power		
		L [3 W/ft]	M [6 W/ft]	H [10 W/ft]
CCT	927	176	352	617
	930	192	383	670
	935	227	455	796
	940	270	540	946
	WD ²	135	280	405
	UGR ³	26.7	29.3	31.1

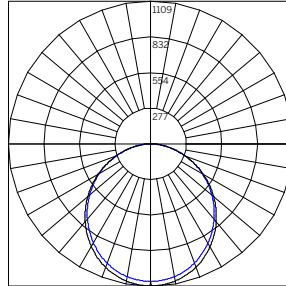

BEAM ANGLE (0-180) = 110.3
BEAM ANGLE (90-270) = 110.4

ILLUMINANCE - 48" OD H 3500K
WG-20LD-...-S-48-H-935-...-OD-X-XXX-X-XX-W¹

Mounting Height [ft]	Illuminance [fc at max cd]	Beam Width [ft]
2	227	5.7
4	69	11.5
6	31	17.2
8	17	23
10	11	28.7
12	8	34.5
14	6	40.2
16	4	46
18	3	51.7
20	3	57.5

WG-20LD-...-MPL-X-XXX-X-XX-W
Delivered Lumens Per Foot

		Power		
		L [3 W/ft]	M [6 W/ft]	H [10 W/ft]
CCT	927	209	418	731
	930	227	454	795
	935	270	540	944
	940	321	641	1122
	WD ²	160	332	480
	UGR ³	26.3	28.9	30.7

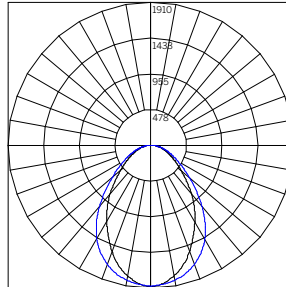

BEAM ANGLE (0-180) = 85.5
BEAM ANGLE (90-270) = 73.8

ILLUMINANCE - 48" MPL H 3500K
WG-20LD-...-S-48-H-935-...-MPL-X-XXX-X-XX-W¹

Mounting Height [ft]	Illuminance [fc at max cd]	Beam Width [ft]
2	478	3.7
4	119	7.4
6	53	11.1
8	30	14.8
10	19	18.5
12	13	22.2
14	10	25.9
16	7	29.6
18	6	33.3
20	5	37

Power Multiplier			
	L [3 W/ft]	M [6 W/ft]	H [10 W/ft]
9XX	0.29	0.57	1.00
WD	0.17	0.35	0.51

CCT Multiplier				
	927	930	935	940
	0.77	0.84	1.00	1.19

- 1 Polar Plot and Cone of Light are applicable to part number noted; use Multiplication Factor table to approximate other models or refer to online photometry.
- 2 WD lumen data at maximum output (3000K).
- 3 UGR value noted is the maximum UGR (crosswise) with 935 LEDs / 48" length.

20 Linear Direct/Indirect Suspended

DIRECT

WG-20LD-...-NL16-X-XXX-X-XX-W Delivered Lumens Per Foot				
		Power		
		L [3 W/ft]	M [6 W/ft]	H [10 W/ft]
CCT	927	207	414	725
	930	225	450	787
	935	267	535	936
	940	318	635	1112
	WD ²	158	329	476
UGR ³		17.8	20.3	22.1

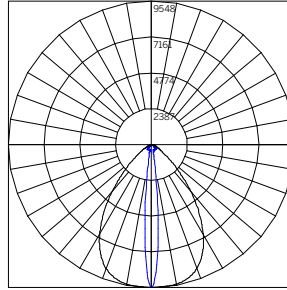

BEAM ANGLE (0-180) = 10.4
BEAM ANGLE (90-270) = 75.1

ILLUMINANCE - 48" NL16 H 3500K WG-20LD-...-S-48-H-935-...-NL16-X-XXX-X-XX-W ¹		
Mounting Height [ft]	Illuminance [fc at max cd]	Beam Width [ft]
2	2387	0.4
4	597	0.7
6	265	1.1
8	149	1.5
10	95	1.8
12	66	2.2
14	49	2.6
16	37	2.9
18	29	3.3
20	24	3.7

WG-20LD-...-BDO-X-XXX-X-XX-W Delivered Lumens Per Foot				
		Power		
		L [3 W/ft]	M [6 W/ft]	H [10 W/ft]
CCT	927	219	438	767
	930	239	477	834
	935	283	566	991
	940	336	673	1177
	WD ²	168	349	504
UGR ³		31.5	34	35.8

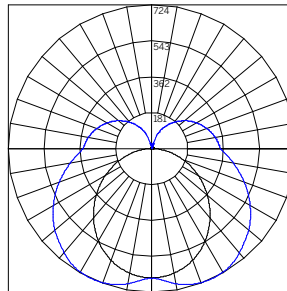

BEAM ANGLE (0-180) = 174.7
BEAM ANGLE (90-270) = 107.8

ILLUMINANCE - 48" BDO H 3500K WG-20LD-...-S-48-H-935-...-BDO-X-XXX-X-XX-W ¹		
Mounting Height [ft]	Illuminance [fc at max cd]	Beam Width [ft]
2	181	86.4
4	45	172.8
6	20	259.3
8	11	345.7
10	7	432.1
12	5	518.5
14	4	605
16	3	691.4
18	2	777.8
20	2	864.2

WG-20LD-...-ROD-X-XXX-X-XX-W Delivered Lumens Per Foot				
		Power		
		L [3 W/ft]	M [6 W/ft]	H [10 W/ft]
CCT	927	248	497	870
	930	271	540	945
	935	321	642	1123
	940	381	763	1335
	WD ²	190	395	571
UGR ³		30.8	33.4	35.2

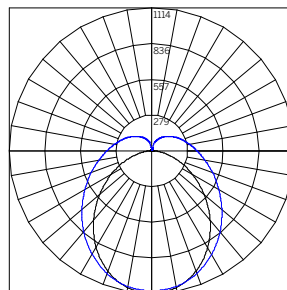

BEAM ANGLE (0-180) = 130.1
BEAM ANGLE (90-270) = 97.2

ILLUMINANCE - 48" ROD H 3500K WG-20LD-...-S-48-H-935-...-BDO-X-XXX-X-XX-W ¹		
Mounting Height [ft]	Illuminance [fc at max cd]	Beam Width [ft]
2	279	8.6
4	70	17.2
6	31	25.8
8	17	34.4
10	11	43
12	8	51.6
14	6	60.2
16	4	68.8
18	3	77.4
20	3	86

Power Multiplier			
	L [3 W/ft]	M [6 W/ft]	H [10 W/ft]
9XX	0.29	0.57	1.00
WD	0.17	0.35	0.51

CCT Multiplier				
	927	930	935	940
	0.77	0.84	1.00	1.19

- 1 Polar Plot and Cone of Light are applicable to part number noted; use Multiplication Factor table to approximate other models or refer to online photometry.
- 2 WD lumen data at maximum output (3000K).
- 3 UGR value noted is the maximum UGR (crosswise) with 935 LEDs / 48" length.

20 Linear Direct/Indirect Suspended

INDIRECT

WG-20LI-...-X-XXX-X-XX-...-OD-W
Delivered Lumens Per Foot

		Power			
		L [3 W/ft]	M [6 W/ft]	H [10 W/ft]	RGBW [7.6 W/ft]
CCT	927	176	352	617	-
	930	192	383	670	-
	935	227	455	796	-
	940	270	540	946	-
	WD ²	135	280	405	-
	RGBW ³	-	-	-	229
UGR ⁴		-	-	-	-

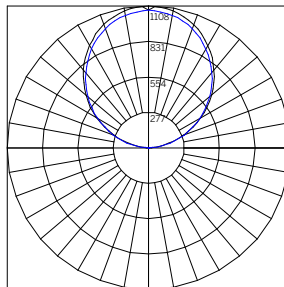

BEAM ANGLE (0-180) = 110.1
BEAM ANGLE (90-270) = 110.1

ILLUMINANCE - 48" OD H 3500K
WWG-20LI-...-S-48"-X-XXX-X-XX-H-935-...-OD-W¹

Offset Distance [ft]	Illuminance [fc at max cd]	Beam Width [ft]
2	277	5.7
4	69	11.4
6	31	17.2
8	17	22.9
10	11	28.6
12	8	34.3
14	6	40.1
16	4	45.8
18	3	51.5
20	3	57.2

WG-20LI-...-X-XXX-X-XX-...-SD-W
Delivered Lumens Per Foot

		Power			
		L [3 W/ft]	M [6 W/ft]	H [10 W/ft]	RGBW [7.6 W/ft]
CCT	927	248	495	867	-
	930	270	538	942	-
	935	319	640	1119	-
	940	380	760	1330	-
	WD ²	190	394	569	-
	RGBW ³	-	-	-	322
UGR ⁴		-	-	-	-

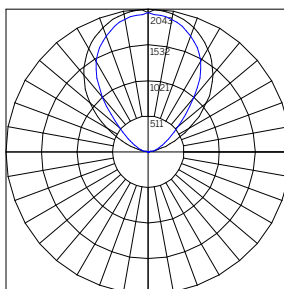

BEAM ANGLE (0-180) = 80.2
BEAM ANGLE (90-270) = 100.7

ILLUMINANCE - 48" SD H 3500K
WG-20LI-...-S-48-X-XXX-X-XX-H-935-...-SD-W¹

Offset Distance [ft]	Illuminance [fc at max cd]	Beam Width [ft]
2	511	3.4
4	128	6.7
6	57	10.1
8	32	13.5
10	20	16.8
12	14	20.2
14	10	23.6
16	8	26.9
18	6	30.3
20	5	33.7

Power Multiplier				
	L [3 W/ft]	M [6 W/ft]	H [10 W/ft]	RGBW [7.6 W/ft]
9XX/RGBW	0.29	0.57	1.00	0.29
WD	0.17	0.35	0.51	-
CCT Multiplier				
	927	930	935	940
	0.77	0.84	1.00	1.19

- 1 Polar Plot and Cone of Light are applicable to part number noted; use Multiplication Factor table to approximate other models or refer to online photometry.
- 2 WD lumen data at maximum output (3000K).
- 3 RGBW lumen data at maximum output with 3000K White LED.
- 4 UGR value noted is the maximum UGR (crosswise) with 935 LEDs / 48" length.