



Contents

- 2 product configurator
- 2 diagrams
- 3 canopies / drivers



21.7" (60W)



27.6" (74W)



35.4" (90W)

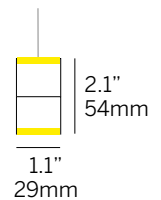

General: Tour Slim represents the newest addition to our popular Tour family of suspensions. Thanks to its slimline profile, Tour Slim fits discretely into any space, from residential to commercial. The new silicone diffuser ensures soft, well-defined illumination without sacrificing anything in terms of output. Available in Round with Direct and Direct/Indirect emission, and Elliptical, with Direct illumination.

Fixture Body: Powder Coated Aluminum 6060 (superior corrosion resistance).

Diffuser: Opaline silicone.

Mounting: Suspension.

Dimensions/Weight: 21.7" (6.17 lbs) – 27.6" (7.94 lbs) – 35.4" (10.14 lbs)

Driver: 120-277V. Integral inside canopy (0-10V Dimming), or Remote (0-10V Dimming or Non-Dim).

Operation: Constant Voltage, 24V DC (CV).

Wattages: 21.7": 60W (30W+30W) – 27.6": 74W (37W+37W) – 35.4": 90W (45W+45W).

Suspension Cable Length: Max 190.9".

IP rating: IP40. Fixture is protected against solid objects greater than 0.04".

ETL Certification: ETL, dry location

Optics: Fixed, Direct + Indirect (50% Down/ 50% Up). General Illumination.

Color temperatures: 2700K – 3000K – 3500K – 4000K.

CRI: 90+

Lumen Maintenance: L70 projections tested at Tj 65° C and Ta 25°.

Warranty: 5-year Limited Warranty on fixtures. 1-year Limited Warranty on Remote Drivers.

Delivered Lumens*	21.7" (60W)	27.6" (74W)	35.4" (90W)
GE	4110 (2055+2055)	4974 (2487+2487)	6208 (3104+3104)

*Values shown for 3000K

Ordering Information								
Product	Trim	Type	Diameter	Wattage/Operation	Color Temp	Optic	+	Driver
TOUS = Tour Slim	ROWH = Round White ROBL = Round Black ROBG = Round Brushed Gold ROBC = Round Brushed Copper	DIIN = Direct + Indirect Distr.	22 = 21.7"	60 CV = 30W+30W / Remote Constant Voltage 24VDC	27 = 2700K 30 = 3000K 35 = 3500K 40 = 4000K	GE = General Distribution (108°+108°)		Remote Driver: 64575+OT96-D010 64670+OT96-D010 64189+OT96-D010 64179+OT96-D010 Driver in Canopy: E64578 E65142 E64039 E64038 E65324 E65326 E-F300011 E-F300012

Ordering Information								
Product	Trim	Type	Diameter	Wattage/Operation	Color Temp	Optic	+	Driver
TOUS = Tour Slim	ROWH = Round White ROBL = Round Black ROBG = Round Brushed Gold ROBC = Round Brushed Copper	DIIN = Direct + Indirect Distr.	28 = 27.6"	74 CV = 37W+37W / Remote Constant Voltage 24VDC	27 = 2700K 30 = 3000K 35 = 3500K 40 = 4000K	GE = General Distribution (112°+112°)		Remote Driver: 64575+OT96-D010 64670+OT96-D010 64189+OT96-D010 64179+OT96-D010 Driver in Canopy: E64578 E65142 E64039 E64038 E65324 E65326 E-F300011 E-F300012

Ordering Information								
Product	Trim	Type	Diameter	Wattage/Operation	Color Temp	Optic	+	Driver
TOUS = Tour Slim	ROWH = Round White ROBL = Round Black ROBG = Round Brushed Gold ROBC = Round Brushed Copper	DIIN = Direct + Indirect Distr.	35 = 35.4"	90 CV = 45W+45W / Remote Constant Voltage 24VDC	27 = 2700K 30 = 3000K 35 = 3500K 40 = 4000K	GE = General Distribution (121°+121°)		Remote Driver: 64575+OT96-D010 64670+OT96-D010 64189+OT96-D010 64179+OT96-D010 Driver in Canopy: E65324 E65326 E-F300011 E-F300012

21.7" 60W

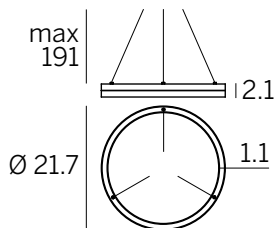

27.6" 74W

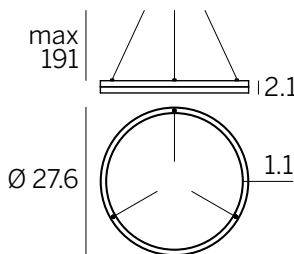

35.4" 90W

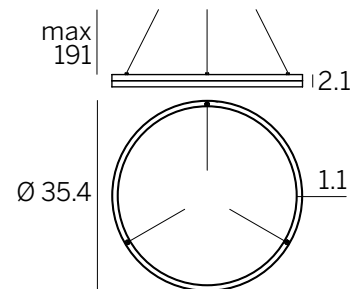

Emissions range

Tour Slim comes with two different emissions: direct, and direct-indirect. Two lighting effects that can be combined with each other in countless combinations to transform the environments with a minimal and contemporary light.

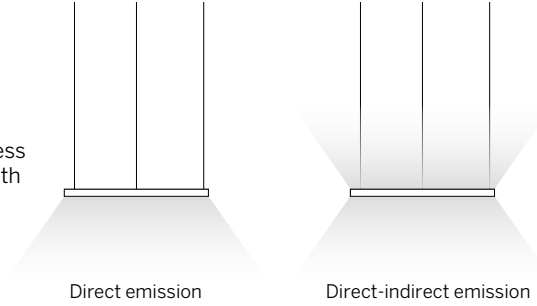

3-cone fixing kit (Remote Driver)

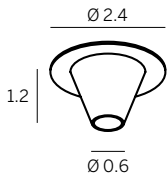

type

White	64575
Black	64670

Gold	64189
Copper	64179

Note: 96.5"Ø requires two fixing kits with 3-cones each

OT96-D010

Osram, 10% 0-10V dim, 96W, 24VDC, 120-277VAC, supplied in a Dry location enclosure

Final result

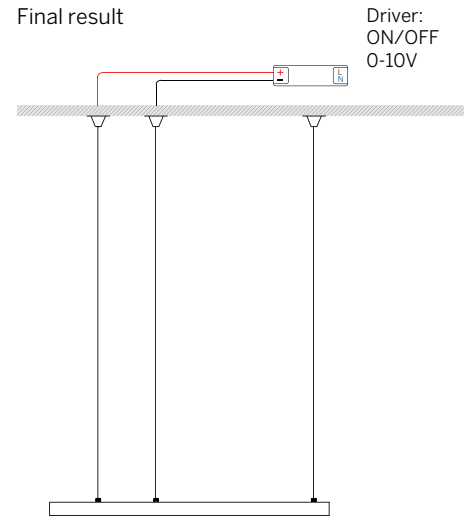

3-coupling point ceiling canopy for single control (Integral 0-10V dimming driver in canopy)

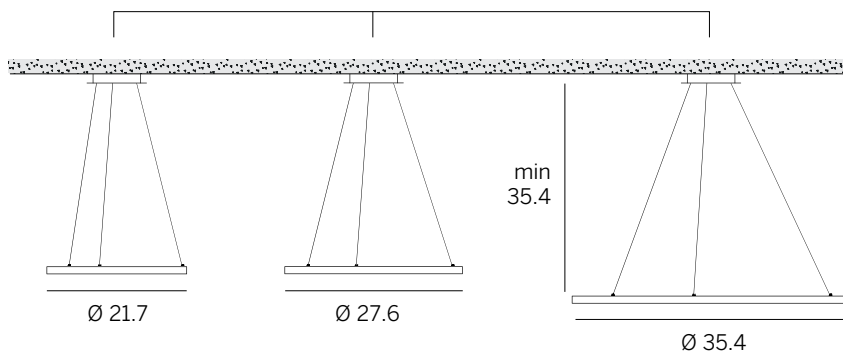
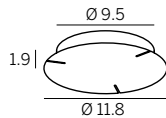

White	E64578
Black	E65142
Gold	E64039
Copper	E64038

3-coupling point ceiling canopy for dual control (Integral 0-10V dimming driver in canopy)

