

FLEX 50x30 VERTICAL

0.79x0.71"

- STATIC WHITE
- FREE CUT
- TUNABLE WHITE
- WARM DIM
- RGB / RGBW
- PIXEL

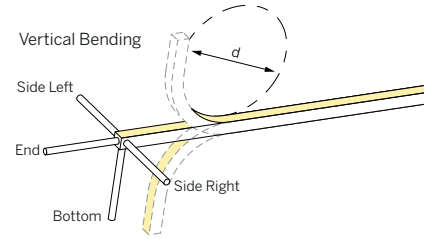
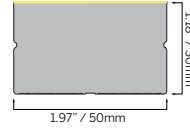

SPECIFICATION	
MATERIAL	Silicone
MOUNTING	Surface
IP RATING	IP67, IP20
BINNING	3 Step
LIFETIME (L70)	50,000hrs based on LM-80 & TM-21 applicable test data
DRIVER REQUIREMENT	24VDC Constant voltage
PROTECTION	UV, flame, salt and chlorine resistant
WARRANTY	5 Years

STATIC WHITE (CRI >90 Ra)

SPECIFICATION (MINIMUM BEND DIAMETER >19.7" / 500 mm)

- DRIVERS
- IES FILES

DRIVER OPTIONS (See driver page for details)	
D010 = eldoLED, 10%, 0-10V dimming, 120-277V	DALI-DT6 = eldoLED DALI (DT6), 0.1% dimming, 120-277V
EL96 = eldoLED 24V, 0.1% 0-10V dimming, 120-277V	UNV96-WL = 0-10V / Phase Dim 96W Wet Location, 1% dimming, 120-277V
DPH = Phase Dimming, 1% dimming, 120V only	
L3D0E = Lutron Hi-lume Premier 0.1% EcoSystem, 120-277V	UNV384-WL = 0-10V / Phase Dim 384W Wet Location, 1% dimming, 120-277V

Cut Interval	DELIVERED LUMENS lm/ft							
	1800K	2400K	2700K	3000K	3500K	4000K	6000K	
S05 50 mm (2")	54	70	77	82	84	87	85	
S12 50 mm (2")	124	162	177	190	194	199	197	

ORDERING INFORMATION								
MODEL	JACKET	CCT	LED TYPE	CABLE ENTRY	IP RATING	CABLE LENGTH	LENGTH	DRIVERS
63S5030V Flex 50x30 Vertical	1 White	C18 1800K	S05 5 W/m (15m max.)	E End	7 IP67	003 0.3m (1ft)	.XXXX Length in inches	D010
		C24 2400K	1.5 W/ft (49.2ft max.)	B Bottom	2 IP20	010 1m (3.3ft)		EL96
		C27 2700K	S12 12 W/m (6m max.)	SL Side Left		030 3m (9.8ft)		DPH
		C30 3000K	3.7 W/ft (19.7ft max.)	SR Side Right		050 5m (16.4ft)		L3D0E
		C35 3500K				100 10m (32.8ft)		DALI-DT6
		C40 4000K						UNV96-WL
C60 6000K					UNV384-WL			
63S5030V	1							

STATIC WHITE - HIGH OUTPUT (CRI >90 Ra)

SPECIFICATION (MINIMUM BEND DIAMETER >19.7" / 500 mm)

- DRIVERS

DRIVER OPTIONS (See driver page for details)	
D010 = eldoLED, 10%, 0-10V dimming, 120-277V	DALI-DT6 = eldoLED DALI (DT6), 0.1% dimming, 120-277V
EL96 = eldoLED 24V, 0.1% 0-10V dimming, 120-277V	UNV96-WL = 0-10V / Phase Dim 96W Wet Location, 1% dimming, 120-277V
DPH = Phase Dimming, 1% dimming, 120V only	
L3D0E = Lutron Hi-lume Premier 0.1% EcoSystem, 120-277V	UNV384-WL = 0-10V / Phase Dim 384W Wet Location, 1% dimming, 120-277V

Cut Interval	DELIVERED LUMENS lm/ft							
	1800K	2400K	2700K	3000K	3500K	4000K	6000K	
S13 62.5 mm (2.5")	213	278	301	327	333	334	338	

ORDERING INFORMATION								
MODEL	JACKET	CCT	LED TYPE	CABLE ENTRY	IP RATING	CABLE LENGTH	LENGTH	DRIVERS
63S5030HOV Flex 50x30 Vertical High Output	1 White	C18 1800K	S13 13.5 W/m (5m max.)	E End	7 IP67	003 0.3m (1ft)	.XXXX Length in inches	D010
		C24 2400K	4.1 W/ft (16.4ft max.)	B Bottom	2 IP20	010 1m (3.3ft)		EL96
		C27 2700K		SL Side Left		030 3m (9.8ft)		DPH
		C30 3000K		SR Side Right		050 5m (16.4ft)		L3D0E
		C35 3500K				100 10m (32.8ft)		DALI-DT6
		C40 4000K						UNV96-WL
C60 6000K					UNV384-WL			
63S5030HOV	1		S13					

FLEX 50x30 VERTICAL

0.79x0.71"



- STATIC WHITE
- FREE CUT
- TUNABLE WHITE
- WARM DIM
- RGB/RGBW
- PIXEL

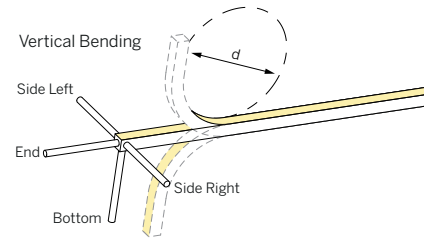
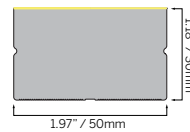

SPECIFICATION	
MATERIAL	Silicone
MOUNTING	Surface
IP RATING	IP67, IP20
BINNING	3 Step
LIFETIME (L70)	50,000hrs based on LM-80 & TM-21 applicable test data
DRIVER REQUIREMENT	24VDC Constant voltage
PROTECTION	UV, flame, salt and chlorine resistant
WARRANTY	5 Years

STATIC WHITE FREE CUT (CRI >90 Ra)

SPECIFICATION (MINIMUM BEND DIAMETER >19.7" / 500 mm)

- DRIVERS
- IES FILES

DRIVER OPTIONS (See driver page for details)	
D010 = eldoLED, 10%, 0-10V dimming, 120-277V	DALI-DT6 = eldoLED DALI (DT6), 0.1% dimming, 120-277V
EL96 = eldoLED 24V, 0.1% 0-10V dimming, 120-277V	UNV96-WL = 0-10V / Phase Dim 96W Wet Location, 1% dimming, 120-277V
DPH = Phase Dimming, 1% dimming, 120V only	
L3D0E = Lutron Hi-lume Premier 0.1% EcoSystem, 120-277V	UNV384-WL = 0-10V / Phase Dim 384W Wet Location, 1% dimming, 120-277V

Cut Interval	DELIVERED LUMENS lm/ft							
	1800K	2400K	2700K	3000K	3500K	4000K	6000K	
SF05	Free Cut	46	60	71	71	73	79	74
SF12	Free Cut	107	140	163	165	168	181	170

- ACCESSORIES

ORDERING INFORMATION								
MODEL	JACKET	CCT	LED TYPE	CABLE ENTRY	IP RATING	CABLE LENGTH	LENGTH	DRIVERS
63S5030V Flex 50x30 Vertical	1 White	C18 1800K	SF05 5 W/m (12.5m max.) 1.5 W/ft (41ft max.)	E End B Bottom SL Side Left SR Side Right	7 IP67 2 IP20	003 0.3m (1ft)	.XXXX Length in inches	D010 EL96 DPH L3D0E DALI-DT6 UNV96-WL UNV384-WL
		C24 2400K				010 1m (3.3ft)		
		C27 2700K	030 3m (9.8ft)					
		C30 3000K	050 5m (16.4ft)					
		C35 3500K	100 10m (32.8ft)					
		C40 4000K						
C60 6000K								
63S5030V	1							



FLEX 50x30 VERTICAL

0.79x0.71"

- STATIC WHITE
- FREE CUT
- TUNABLE WHITE
- WARM DIM
- RGB/RGBW
- PIXEL

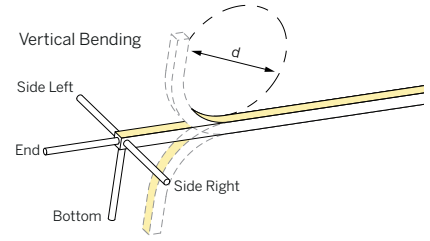
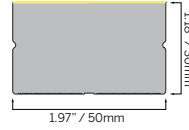

SPECIFICATION	
MATERIAL	Silicone
MOUNTING	Surface
IP RATING	IP67, IP20
BINNING	3 Step
LIFETIME (L70)	50,000hrs based on LM-80 & TM-21 applicable test data
DRIVER REQUIREMENT	24VDC Constant voltage
PROTECTION	UV, flame, salt and chlorine resistant
WARRANTY	5 Years

TUNABLE WHITE (CRI >90 Ra)

SPECIFICATION (MINIMUM BEND DIAMETER >19.7" / 500 mm)

- DRIVERS

DRIVER OPTIONS (See driver page for details)
DALI-DT6 = eldoLED DALI (DT6), 0.1% dimming, 120-277V
DALI-DT8 = eldoLED DALI (DT8), 0.1% dimming, 120-277V

	Cut Interval	DELIVERED LUMENS lm/ft						
		1800K	2400K	2700K	3000K	3500K	4000K	6000K
CT10	62.5 mm (2.5")	92	129	141	149	150	151	157

- IES FILES

ORDERING INFORMATION										
MODEL	JACKET	CCT (LOW)	CCT (HIGH)	LED TYPE*	CABLE ENTRY	IP RATING	CABLE LENGTH	LENGTH	DRIVERS	
63S5030V Flex 50x30 Vertical	1 White	C18 1800K	24 2400K	CT10 2x9.6 W/m (7m max.) 2x2.9 W/ft (23ft max.) <small>* Rated wattage is maximum wattage per channel. Combined power must also not exceed this value.</small>	E End B Bottom SL Side Left SR Side Right	7 IP67 2 IP20	003 0.3m (1ft)	.XXXX Length in inches	DALI-DT6 DALI-DT8	
		C24 2400K	27 2700K				010 1m (3.3ft)			
		C27 2700K	30 3000K				030 3m (9.8ft)			
		C30 3000K	35 3500K				050 5m (16.4ft)			
		C35 3500K	40 4000K				100 10m (32.8ft)			
		C40 4000K	60 6000K							
63S5030V	1			CT10						

TUNABLE WHITE - HIGH OUTPUT (CRI >90 Ra)

SPECIFICATION (MINIMUM BEND DIAMETER >19.7" / 500 mm)

- DRIVERS

DRIVER OPTIONS (See driver page for details)
DALI-DT6 = eldoLED DALI (DT6), 0.1% dimming, 120-277V
DALI-DT8 = eldoLED DALI (DT8), 0.1% dimming, 120-277V

	Cut Interval	DELIVERED LUMENS lm/ft						
		1800K	2400K	2700K	3000K	3500K	4000K	6000K
CT10	83.3 mm (3.3")	146	205	226	237	239	241	251
CT13	83.3 mm (3.3")	190	266	293	308	310	313	326

ORDERING INFORMATION										
MODEL	JACKET	CCT (LOW)	CCT (HIGH)	LED TYPE*	CABLE ENTRY	IP RATING	CABLE LENGTH	LENGTH	DRIVERS	
63S5030HOV Flex 50x30 Vertical High Output	1 White	C18 1800K	24 2400K	CT10 2x10 W/m (4m max.) 2x3 W/ft (13.1ft max.) CT13 2x13 W/m (3m max.) 2x4 W/ft (9.8ft max.) <small>* Rated wattage is maximum wattage per channel. Combined power must also not exceed this value.</small>	E End B Bottom SL Side Left SR Side Right	7 IP67 2 IP20	003 0.3m (1ft)	.XXXX Length in inches	DALI-DT6 DALI-DT8	
		C24 2400K	27 2700K				010 1m (3.3ft)			
		C27 2700K	30 3000K				030 3m (9.8ft)			
		C30 3000K	35 3500K				050 5m (16.4ft)			
		C35 3500K	40 4000K				100 10m (32.8ft)			
		C40 4000K	60 6000K							
63S5030HOV	1									

FLEX 50x30 VERTICAL

0.79x0.71"



- STATIC WHITE
- FREE CUT
- TUNABLE WHITE
- WARM DIM
- RGB/RGBW
- PIXEL

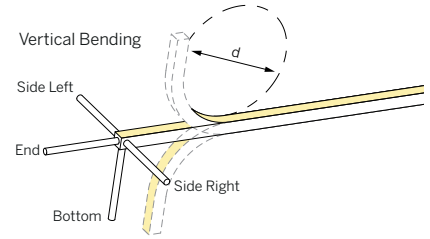
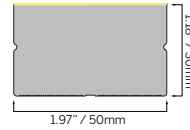

SPECIFICATION	
MATERIAL	Silicone
MOUNTING	Surface
IP RATING	IP67, IP20
BINNING	3 Step
LIFETIME (L70)	50,000hrs based on LM-80 & TM-21 applicable test data
DRIVER REQUIREMENT	24VDC Constant voltage
PROTECTION	UV, flame, salt and chlorine resistant
WARRANTY	5 Years

WARM DIM (CRI >90 Ra)

SPECIFICATION (MINIMUM BEND DIAMETER >19.7" / 500 mm)

DRIVERS	DRIVER OPTIONS (See driver page for details)
	MAGSDM96-WD = 0-10V / Phase Dim 96W, 0.1% CCR Dimming for Warm Dim, 120-277V (Phase - 120V only)

	Cut Interval	DELIVERED LUMENS lm/ft	
		2700K	3000K
14R	83.33 mm (3.3")	149	162

ORDERING INFORMATION										
MODEL	JACKET	CCT	LED TYPE	CABLE ENTRY	IP RATING	CABLE LENGTH	LENGTH			DRIVERS
63S5030V Flex 50x30 Vertical	1 White	C2718W 2700-1800K C3018W 3000-1800K	14R 14 W/m (5m max.) 4.3 W/ft (16.4ft max.)	E End B Bottom SL Side Left SR Side Right	7 IP67 2 IP20	003 0.3m (1ft) 010 1m (3.3ft) 030 3m (9.8ft) 050 5m (16.4ft) 100 10m (32.8ft)	.XXXX Length in inches			MAGSDM96-WD
63S5030V	1		14R							MAGSDM96-WD

FLEX 50x30 VERTICAL

0.79x0.71"



- STATIC WHITE
- FREE CUT
- TUNABLE WHITE
- WARM DIM
- RGB / RGBW
- PIXEL

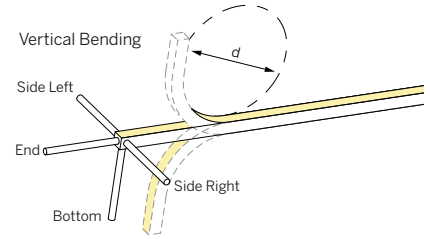
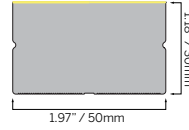

SPECIFICATION	
MATERIAL	Silicone
MOUNTING	Surface
IP RATING	IP67, IP20
BINNING	3 Step
LIFETIME (L70)	50,000hrs based on LM-80 & TM-21 applicable test data
DRIVER REQUIREMENT	24VDC Constant voltage
PROTECTION	UV, flame, salt and chlorine resistant
WARRANTY	5 Years

RGB

SPECIFICATION (MINIMUM BEND DIAMETER >19.7" / 500 mm)

DRIVER OPTIONS (See driver page for details)
DMX = eldoLED, 24V, 0.1% DMX Dimming

	Cut Interval	DELIVERED LUMENS lm/ft		
		RED	GREEN	BLUE
L12	100 mm (3.9")	26	67	15

ORDERING INFORMATION									
MODEL	JACKET	CCT	LED TYPE	CABLE ENTRY	IP RATING	CABLE LENGTH	LENGTH	DRIVERS	
63S5030V Flex 50x30 Vertical	1 White	RGB RGB	L12 12 W/m (5m max.) 3.7 W/ft (16.4ft max.)	E End B Bottom SL Side Left SR Side Right	7 IP67 2 IP20	003 0.3m (1ft) 010 1m (3.3ft) 030 3m (9.8ft) 050 5m (16.4ft) 100 10m (32.8ft)	.XXXX Length in inches	DMX	
63S5030V	1	RGB	L12					DMX	

RGBW

SPECIFICATION (MINIMUM BEND DIAMETER >19.7" / 500 mm)

DRIVER OPTIONS (See driver page for details)
DMX = eldoLED, 24V, 0.1% DMX Dimming

	Cut Interval	DELIVERED LUMENS lm/ft			
		RED	GREEN	BLUE	4000K
L16	100 mm (3.9")	26	67	15	58

ORDERING INFORMATION									
MODEL	JACKET	CCT	LED TYPE	CABLE ENTRY	IP RATING	CABLE LENGTH	LENGTH	DRIVERS	
63S5030V Flex 50x30 Vertical	1 White	RGBW27 RGBW(2700K) RGBW30 RGBW(3000K) RGBW40 RGBW(4000K)	L16 16 W/m (11m max.) 4.9 W/ft (36.1ft max.)	E End B Bottom SL Side Left SR Side Right	7 IP67 2 IP20	003 0.3m (1ft) 010 1m (3.3ft) 030 3m (9.8ft) 050 5m (16.4ft) 100 10m (32.8ft)	.XXXX Length in inches	DMX	
63S5030V	1		L16					DMX	



FLEX 50x30 VERTICAL

0.79x0.71"

- STATIC WHITE
- FREE CUT
- TUNABLE WHITE
- WARM DIM
- RGB / RGBW
- PIXEL

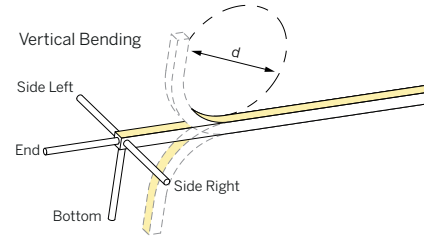
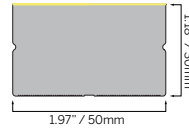

SPECIFICATION	
MATERIAL	Silicone
MOUNTING	Surface
IP RATING	IP67, IP20
BINNING	3 Step
LIFETIME (L70)	50,000hrs based on LM-80 & TM-21 applicable test data
DRIVER REQUIREMENT	24VDC Constant voltage
PROTECTION	UV, flame, salt and chlorine resistant
WARRANTY	5 Years

PIXEL - STATIC WHITE (CRI >90 Ra)

SPECIFICATION (MINIMUM BEND DIAMETER >19.7" / 500 mm)

DRIVER OPTIONS (See driver page for details)
DMX = eldoLED, 24V, 0.1% DMX Dimming

	Pixels	DMX Addresses	Cut Interval	DELIVERED LUMENS lm/ft						
				1800K	2400K	2700K	3000K	3500K	4000K	6000K
DMX10P13	10 /m (3.94")	10 /m (1 /px)	100 mm (3.9")	124	162	175	190	194	199	197

- DRIVERS
- IES FILES
- ACCESSORIES

ORDERING INFORMATION										
MODEL	JACKET	CCT	CCT	LED TYPE	CABLE ENTRY	IP RATING	CABLE LENGTH	LENGTH	DRIVERS	
63S5030V Flex 50x30 Vertical	1 White	C18 1800K	DMX10P13 13.5 W/m (5m max.)	E End B Bottom SL Side Left SR Side Right	7 IP67 2 IP20	003 0.3m (1ft)	.XXXX Length in inches	DMX		
		C24 2400K	4.1 W/ft (16.4ft max.)			010 1m (3.3ft)				
		C27 2700K				030 3m (9.8ft)				
		C30 3000K				050 5m (16.4ft)				
		C35 3500K				100 10m (32.8ft)				
		C40 4000K								
C60 6000K										
63S5030V	1			DMX10P13					DMX	

PIXEL - TUNABLE WHITE (CRI >90 Ra)

SPECIFICATION (MINIMUM BEND DIAMETER >19.7" / 500 mm)

DRIVER OPTIONS (See driver page for details)
DMX = eldoLED, 24V, 0.1% DMX Dimming

	Pixels	DMX Addresses	Cut Interval	DELIVERED LUMENS lm/ft						
				1800K	2400K	2700K	3000K	3500K	4000K	6000K
CTDMX10P13	10 /m (3.94")	20 /m (2 /px)	100 mm (3.9")	57	80	88	93	94	94	99

ORDERING INFORMATION											
MODEL	JACKET	CCT	CCT	LED TYPE	CABLE ENTRY	IP RATING	CABLE LENGTH	LENGTH	DRIVERS		
63S5030V Flex 50x30 Vertical	1 White	C18 1800K	24 2400K	CTDMX10P13 13.5 W/m (5m max.) 14.1 W/ft (16.4ft max.)	E End B Bottom SL Side Left SR Side Right	7 IP67 2 IP20	003 0.3m (1ft)	.XXXX Length in inches	DMX		
		C24 2400K	27 2700K				010 1m (3.3ft)				
		C27 2700K	30 3000K				030 3m (9.8ft)				
		C30 3000K	35 3500K				050 5m (16.4ft)				
		C35 3500K	40 4000K				100 10m (32.8ft)				
		C40 4000K	60 6000K								
63S5030V	1			CTDMX10P13					DMX		

FLEX 50x30 VERTICAL

0.79x0.71"

- STATIC WHITE
- FREE CUT
- TUNABLE WHITE
- WARM DIM
- RGB / RGBW
- PIXEL

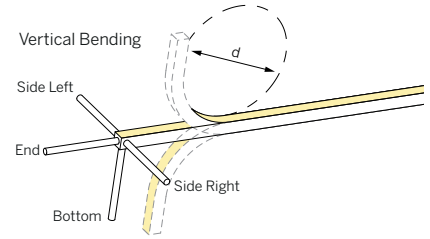
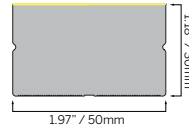

SPECIFICATION	
MATERIAL	Silicone
MOUNTING	Surface
IP RATING	IP67, IP20
BINNING	3 Step
LIFETIME (L70)	50,000hrs based on LM-80 & TM-21 applicable test data
DRIVER REQUIREMENT	24VDC Constant voltage
PROTECTION	UV, flame, salt and chlorine resistant
WARRANTY	5 Years

PIXEL - RGB

SPECIFICATION (MINIMUM BEND DIAMETER >19.7" / 500 mm)

DRIVER OPTIONS (See driver page for details)
DMX = eldoLED, 24V, 0.1% DMX Dimming

	Pixels	DMX Addresses	Cut Interval	DELIVERED LUMENS lm/ft		
				RED	GREEN	BLUE
DMX02P14	2 /m (19.7")	6 /m (3 /px)	500 mm (19.7")	15	41	10
DMX10P14	10 /m (3.94")	30 /m (3 /px)	100 mm (3.9")	15	41	10

- DRIVERS
- IES FILES
- ACCESSORIES

ORDERING INFORMATION									
MODEL	JACKET	CCT	LED TYPE	CABLE ENTRY	IP RATING	CABLE LENGTH	LENGTH	DRIVERS	
63S5030V Flex 50x30 Vertical	1 White	RGB RGB	DMX02P14 14 W/m (5m max.) 4.3 W/ft (16.4ft max.) DMX10P14 14 W/m (5m max.) 4.3 W/ft (16.4ft max.)	E End B Bottom SL Side Left SR Side Right	7 IP67 2 IP20	003 0.3m (1ft) 010 1m (3.3ft) 030 3m (9.8ft) 050 5m (16.4ft) 100 10m (32.8ft)	.XXXX Length in inches	DMX	
63S5030V	1	RGB						DMX	

PIXEL - RGBW

SPECIFICATION (MINIMUM BEND DIAMETER >19.7" / 500 mm)

DRIVER OPTIONS (See driver page for details)
DMX = eldoLED, 24V, 0.1% DMX Dimming

	Pixels	DMX Addresses	Cut Interval	DELIVERED LUMENS lm/ft					
				RED	GREEN	BLUE	2700K	3000K	4000K
DMX10P16	10 /m (3.94")	40 /m (4 /px)	100 mm (3.9")	11	29	7	26	28	29

ORDERING INFORMATION									
MODEL	JACKET	CCT	LED TYPE	CABLE ENTRY	IP RATING	CABLE LENGTH	LENGTH	DRIVERS	
63S5030V Flex 50x30 Vertical	1 White	RGBW27 RGBW(2700K) RGBW30 RGBW(3000K) RGBW40 RGBW(4000K)	DMX10P16 16 W/m (5m max.) 4.9 W/ft (16.4ft max.)	E End B Bottom SL Side Left SR Side Right	7 IP67 2 IP20	003 0.3m (1ft) 010 1m (3.3ft) 030 3m (9.8ft) 050 5m (16.4ft) 100 10m (32.8ft)	.XXXX Length in inches	DMX	
63S5030V	1		DMX10P16					DMX	

FLEX 50x30 VERTICAL

0.79x0.71"

- STATIC WHITE
- FREE CUT
- TUNABLE WHITE
- WARM DIM
- RGB / RGBW
- PIXEL

ACCESSORIES

TYPE Aluminum profile
MOUNTING Surface mount

ORDERING INFORMATION		
MODEL	FINISH	LENGTH
635030X	5AP Silver	0030 30mm (1.18") 1000 1000mm (39.37")
635030X	5AP	

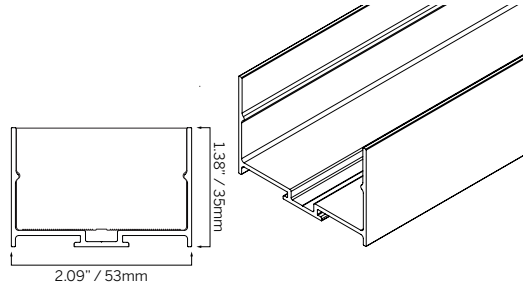

30



1000



DRIVERS

TYPE Aluminum Profile Bendable
MOUNTING Surface mount

ORDERING INFORMATION		
MODEL	FINISH	LENGTH
635030X	5APB Silver	1000 1000mm (39.37")
635030X	5APB	1000

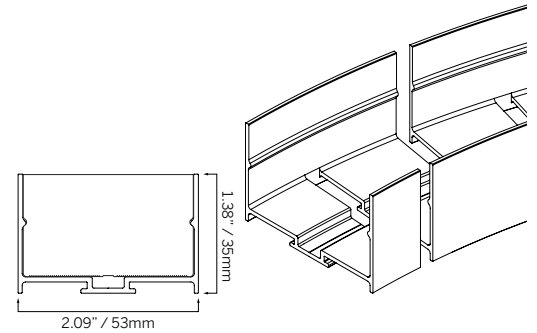

ACCESSORIES

TYPE Stainless Profile Bendable
MOUNTING Surface mount

ORDERING INFORMATION		
MODEL	FINISH	LENGTH
63S1010X	5SC Silver	1000 1000mm (39.37")
63S1010X	5SC	1000

