

Box Cove (Plaster Trim)

PATTERN COFFER (PC)

WG-BC-RPT-PC-...

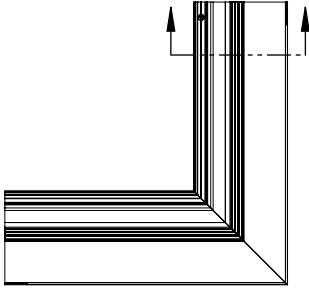

TOP VIEW

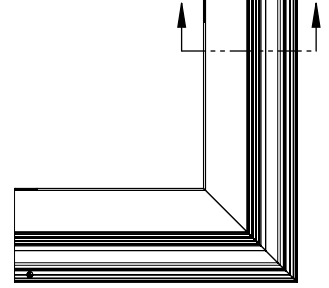
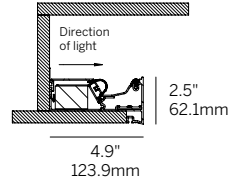
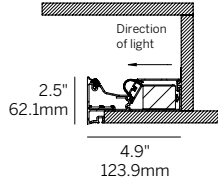

TOP VIEW

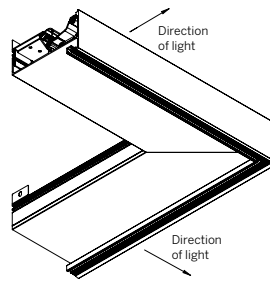
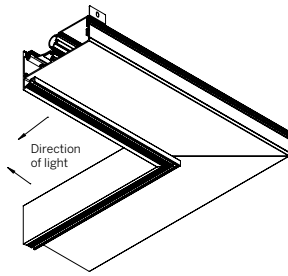

Minimum Angle 56°
Maximum Angle 180°

PLANE TO PLANE INSIDE CORNER (PPI)

WG-BC-RPT-PPI

PLANE TO PLANE OUTSIDE CORNER (PPO)

WG-BC-RPT-PPO

Box Cove (Plaster Trim)

CORNER + STRAIGHT RUN CONNECTIONS

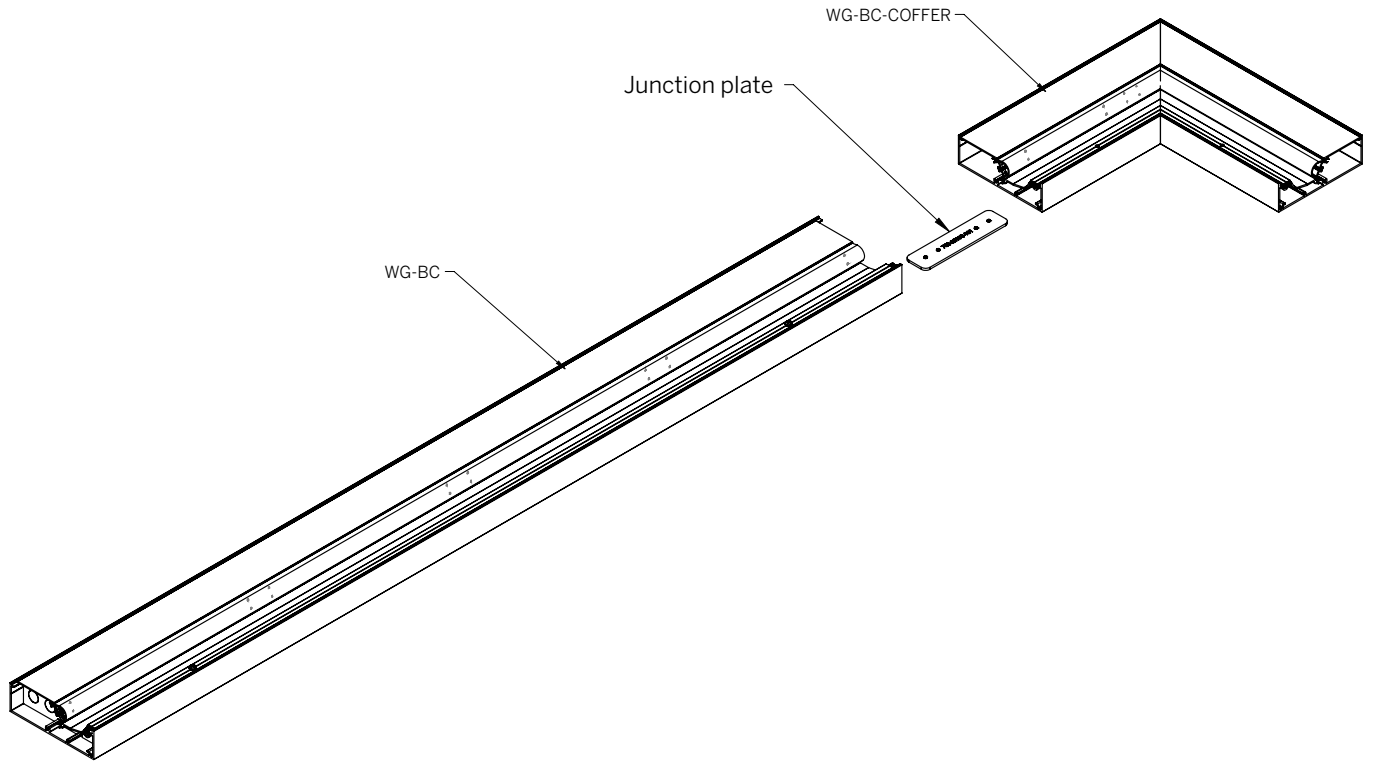

MOUNTING

