

Coves Perimeter



whitegoods











whitegoods







Whitegoods has developed the widest range of architectural cove and perimeter lighting systems. Starting with the Edgeless Cove, designed as the very first knife-edge detail with integral lighting source, to the versions that now offer the highest efficiencies and smallest footprint. All designed to fully integrate into the architecture and of course they all hold true to our constant principles.

- Reduction of detail
- Seamless architectural integration
- Logical, modular systems and families of products
- Ease of specification, installation and maintenance

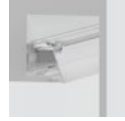
Coves

	Edgeless Cove	38
	Mini Edgeless Cove	40
	Box Cove	42
	Mini Box Cove	44
	Box Cove 2	46
	20 Linear Mini Edgeless Cove	48
	Edgeless P Nose Cove	50
	Edgeless Nose Cove	52

Perimeter

	V Cove	62
	Z Cove	64
	20 Linear Mini Z Cove	66
	20 Linear Perimeter Flush Lens	68
	20 Linear Perimeter Regressed Lens	70
	ProTools 60 Linear Perimeter Recessed	72
	ProTools 60 Linear Wall Graze Recessed	74









The original edgeless cove

Standardized
high performance
optics across all
cove systems

Whitegoods pioneered the use of knife edge cove profiles with fully integrated lighting solutions for continuous runs of light without gaps or shadows. The Whitegoods Edgeless Cove is the original, and still the best of its kind, despite many imitators.

Whitegoods offers the widest range of cove products to suit any application. Coves can be tailored to the specific lengths and are supplied with factory made standard corners, or custom corners.

All Whitegoods products are designed with simple installation and maintenance in mind. Specification is simple too, and we have a fast and accurate system for supplying submittal drawings and documentation.

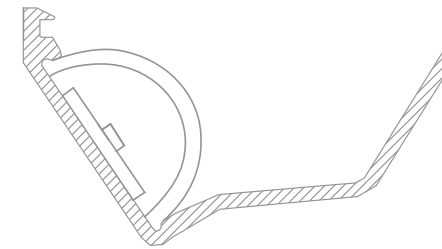

Range Logic

Coves

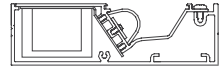

Box Cove
Surface Mount

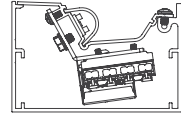

Box Cove 2
Surface/Mullion Mount

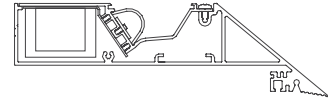

Edgeless Cove
Plaster Trim

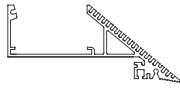

Edgeless P Nose Cove
Plaster Trim

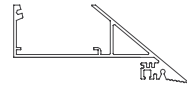

Edgeless Nose Cove
Plaster Trim

Perimeter

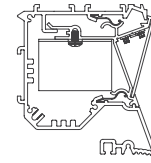

Z Cove
Plaster Trim

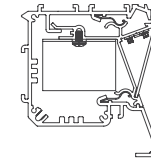

Z Cove
Bezel Trim

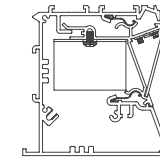

Z Cove
Grid Trim

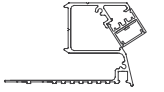

20 Linear Mini Z Cove
Plaster Trim

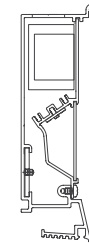

V Cove
Plaster Trim

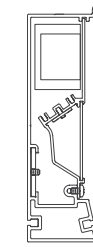

V Cove
Bezel Trim

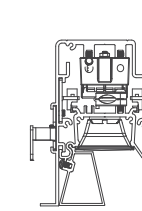

ProTools 60 Linear Wall Graze
Recessed

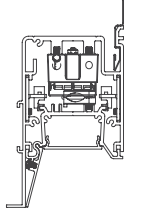

ProTools 60 Linear Perimeter
Recessed

Mini Coves

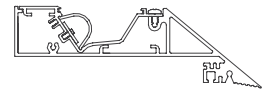

Mini Edgeless Cove
Plaster Trim



Mini Box Cove
Surface Mount

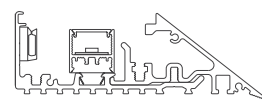

20 Linear Mini Edgeless Cove
Plaster Trim

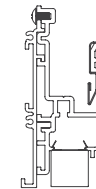

20 Linear Perimeter Flush Lens
Return Trim

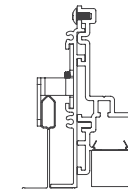

20 Linear Perimeter Flush Lens
Grid Trim

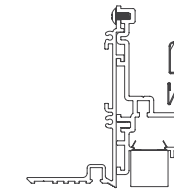

20 Linear Perimeter Flush Lens
Plaster Trim

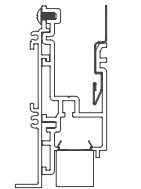

20 Linear Perimeter Flush Lens
Bezel Trim

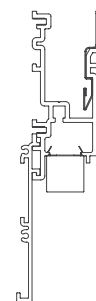

20 Linear Perimeter Regressed Lens
Return Trim

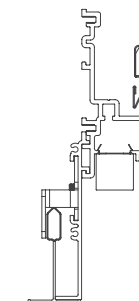

20 Linear Perimeter Regressed Lens
Grid Trim

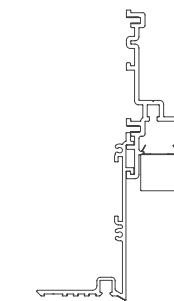

20 Linear Perimeter Regressed Lens
Plaster Trim

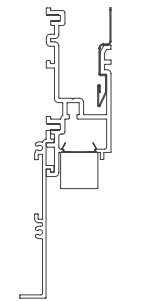

20 Linear Perimeter Regressed Lens
Bezel Trim

Modularity

Whitegoods utilizes modularity throughout the range to ensure maximum efficiency of design, manufacture and maintenance. For the specifier this means absolute consistency across all product types and applications, as well as making sense economically.

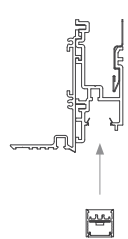

20 Linear Perimeter Flush

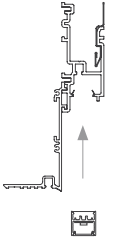

20 Linear Perimeter Regressed

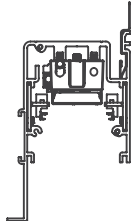

Recessed Perimeter Housing

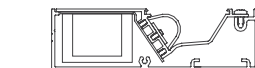

Box Cove



Mini Box Cove

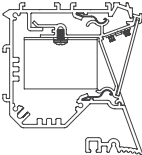

Z Cove Flat Diffuser

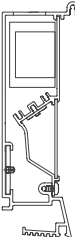

V Cove

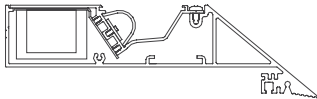

Edgeless Cove

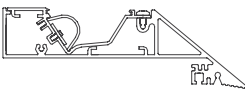

Mini Edgeless Cove

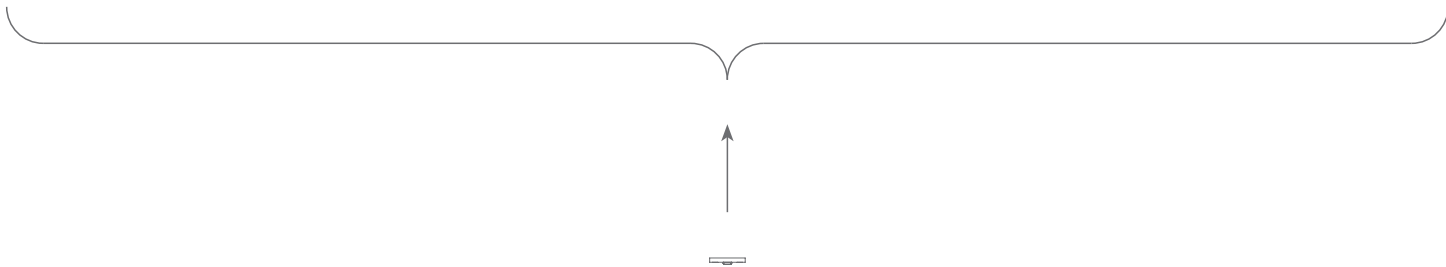

High Performance LED Board

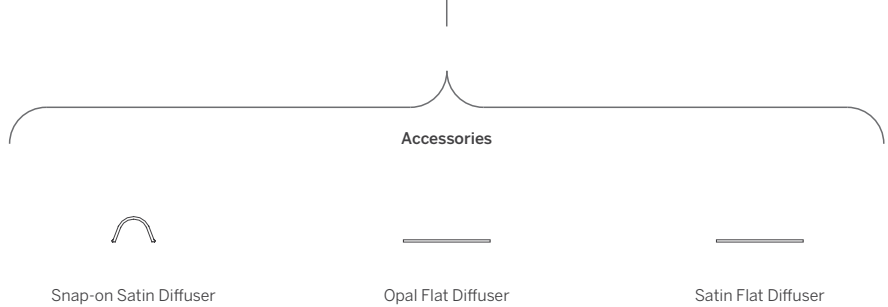
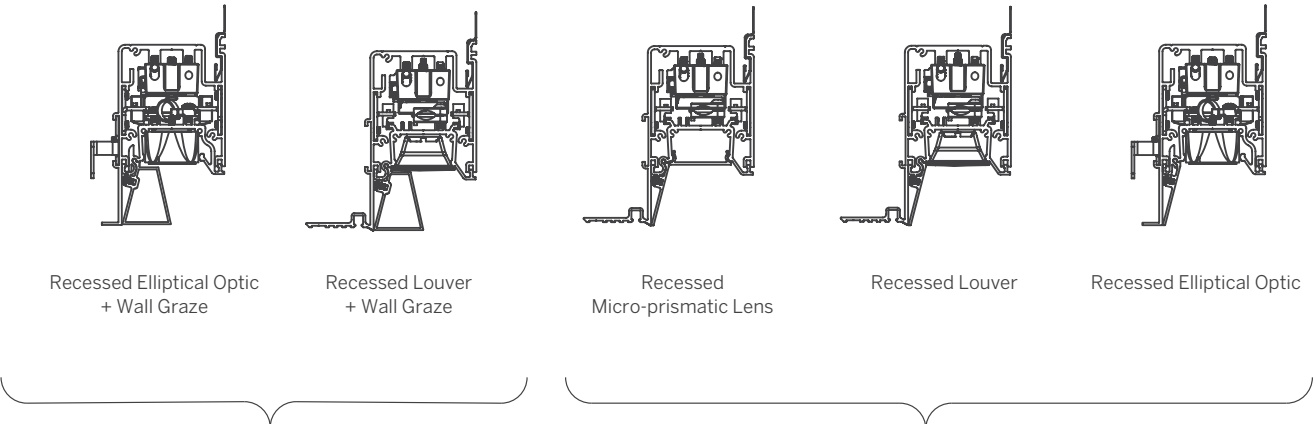
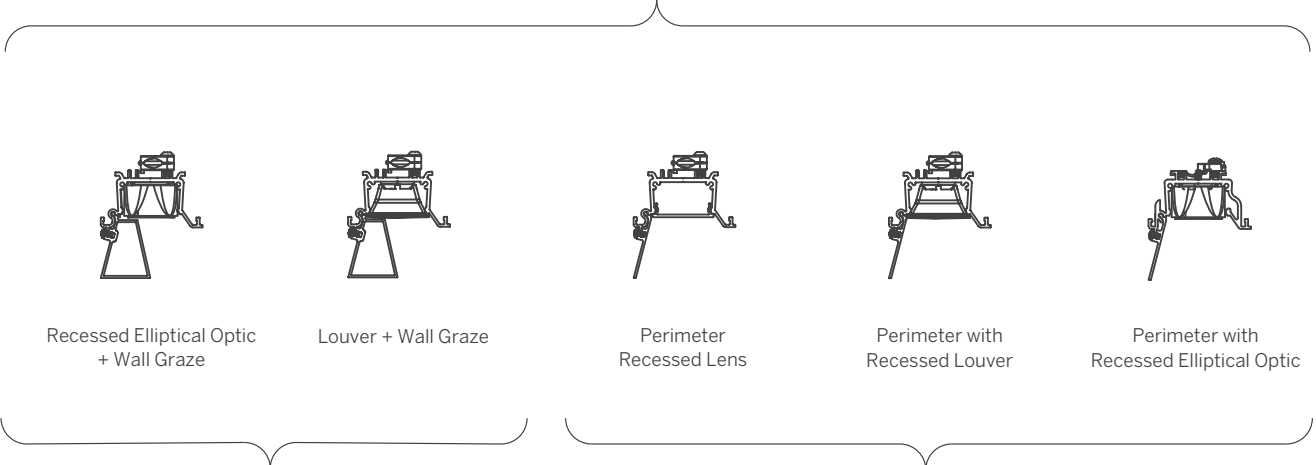

Accessories

Snap-on Satin Diffuser

Opal Flat Diffuser

Satin Flat Diffuser

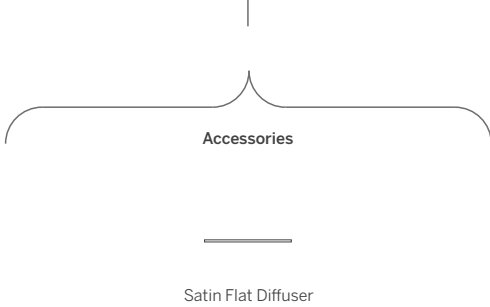

Accessories

Satin Flat Diffuser

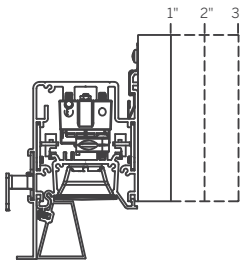

Soft Graze: 1" 2" 3"

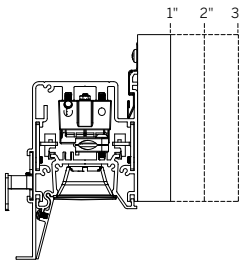

Soft Graze: 1" 2" 3"

Infinite Service Life

This modular design guarantees a long service life without the need to impact the original installation. The electronic components can be maintained or upgraded separately from the fixture housing.

Coves

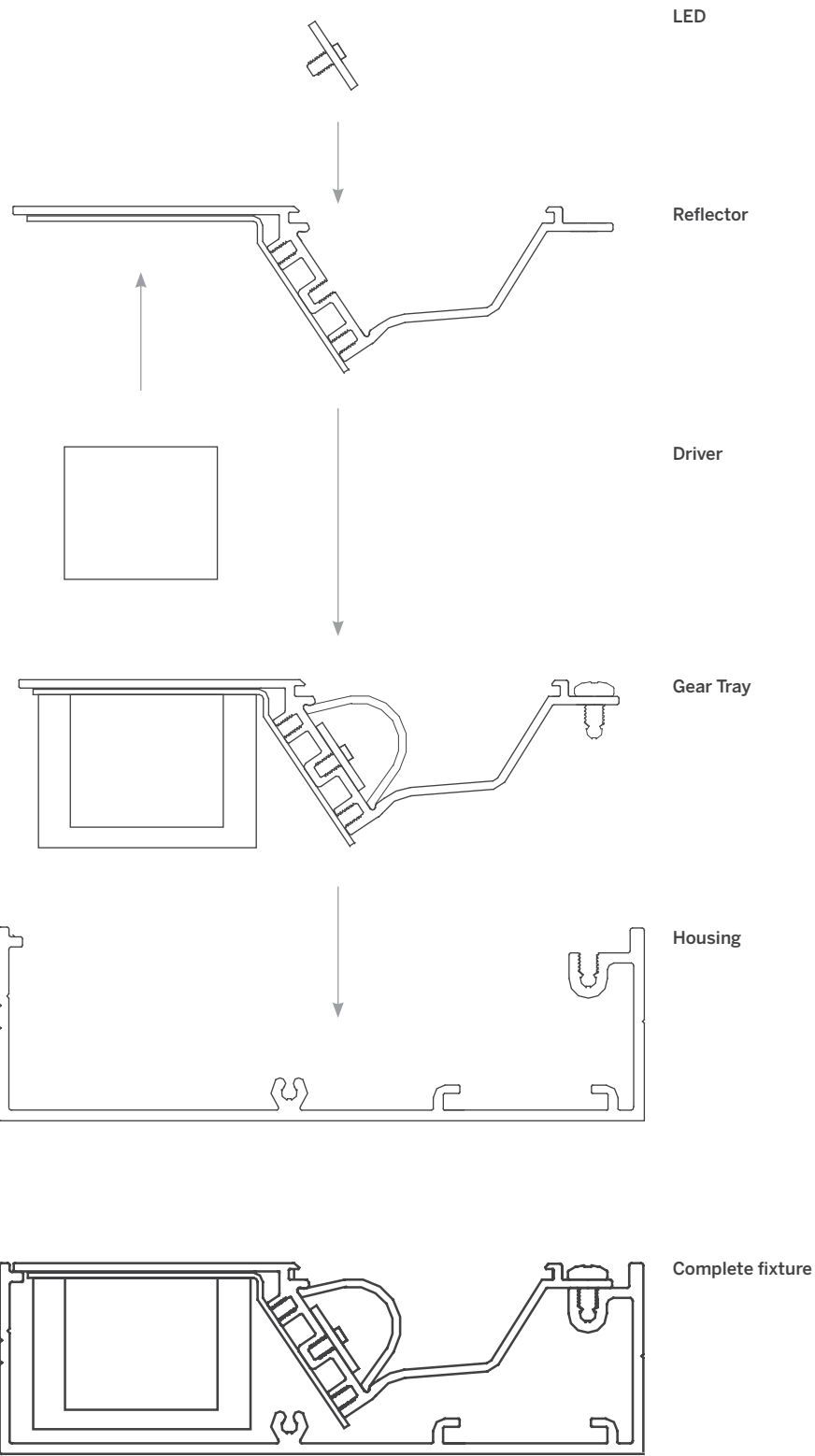

20 Linear Perimeter

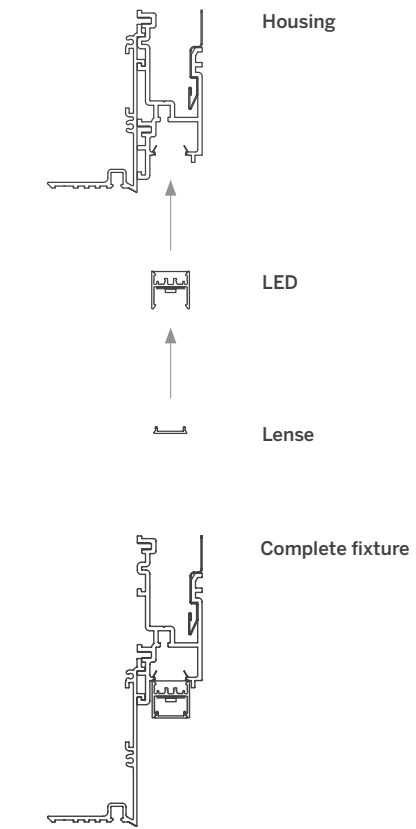

ProTools 60 Linear Perimeter

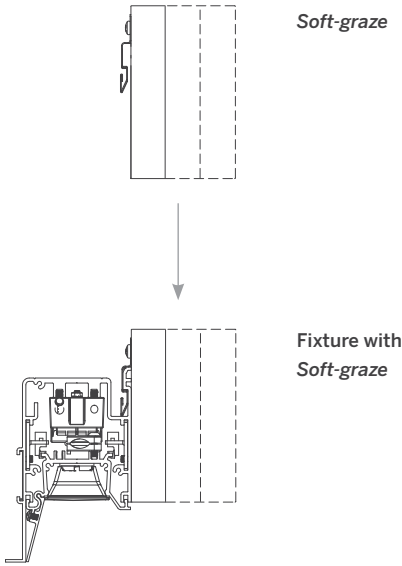
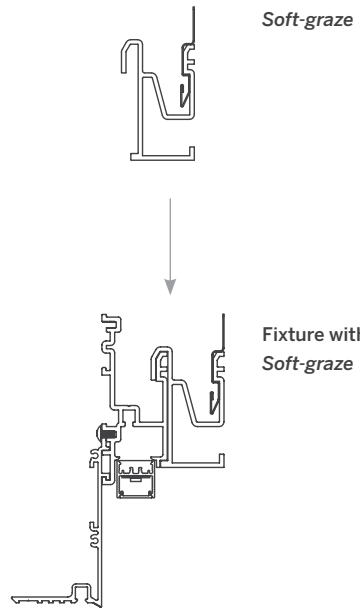
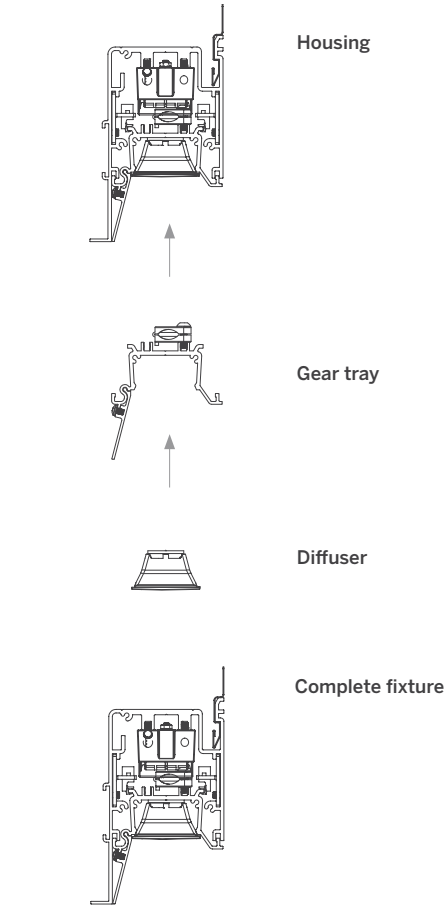

Perimeter Configuration Logic

Whitegoods Perimeter luminaire systems can be specified to any length and in most any pattern. Our designed configuration software determines the exact dimensions required for each and every section. Corners are prefabricated in our factory to keep things simple in the field.

Perimeter: PI Pattern Inside corner

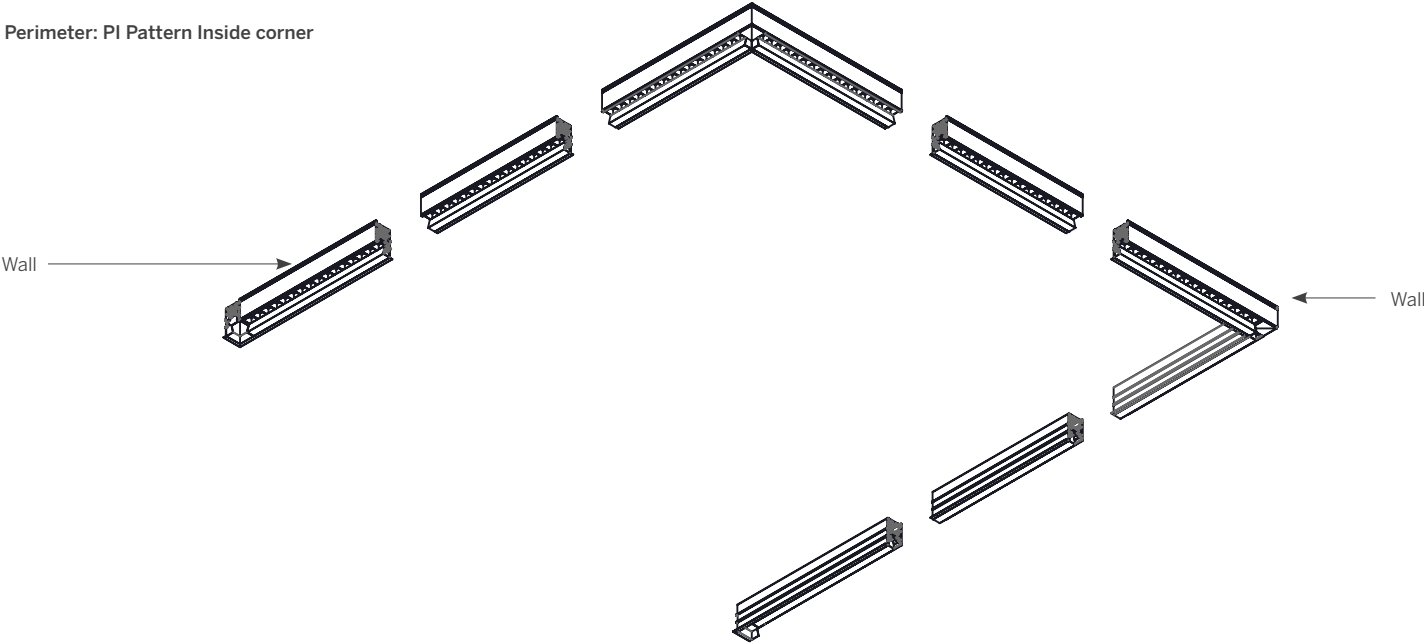

Perimeter: PO Pattern Outside corner

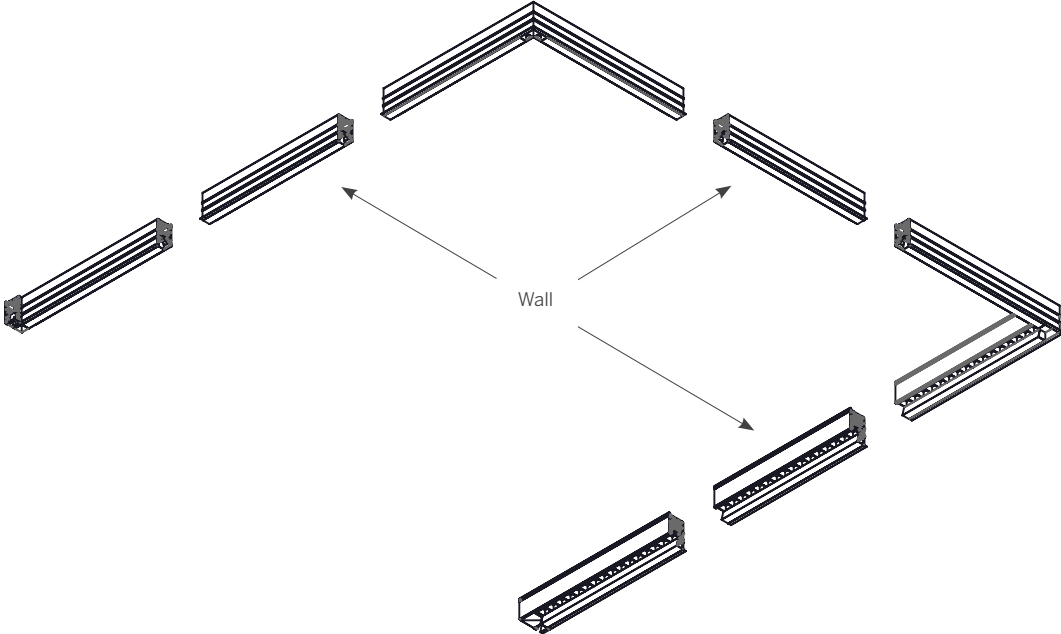

Perimeter Measurements Logic:
A, B, C, = Wall Length

Perimeter: PI Pattern Inside corner

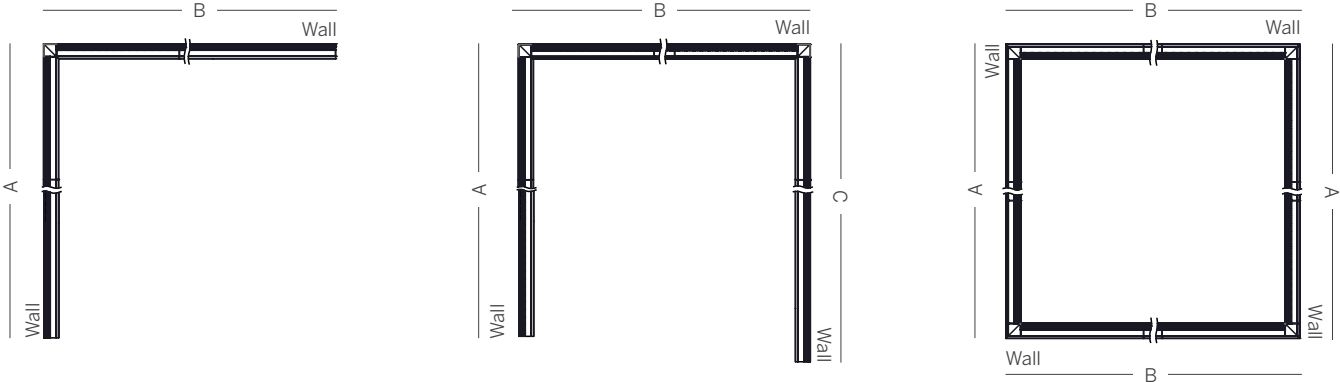

Perimeter: PO Pattern Outside corner

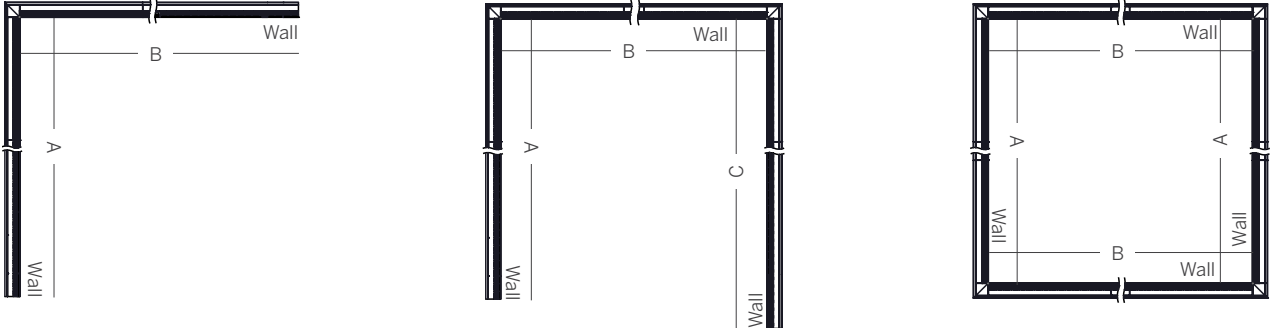

Standard Corners - Plan View

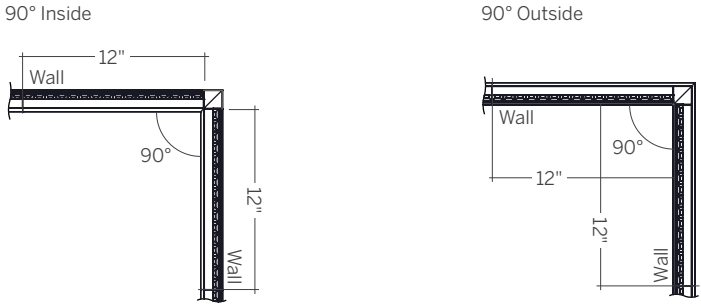



LED Technology

Whitegoods developed a specific LED light source optimized for our linear products, using the highest performance and quality LED devices available on a form factor that best fits our product mechanically and electronically. We use this LED throughout our entire range of 20 Linear, Linear, Cove and Perimeter lighting systems. Additionally, we standardize on the highest quality drivers and control devices to ensure that our system works at peak performance and consistency mile after mile.

Whitegoods products are developed in a modular fashion that allows easy repair or replacement of the light source without upsetting the installation. We term this: future proofing.



- Replaceable light source guarantees sustainability
- Available in any continuous length to accommodate exacting installations
- Multiple wattages and lumen output for maximum flexibility within any application
- Constant Current, 90+ CRI, 3 step MacAdam
- Four standard color temperatures from 2700K-4000K, Tunable White (2200K - 4000K)
- Compatible with all common dimmer and control standards.
- High efficiency design delivers up to 125 lumens/watt
- L70 (TM21 Projected 85°C) 72,000 hours
- Used throughout Whitegoods 20 Linear, Linear, Cove and Perimeter products for color and performance consistency
- 5-year warranty

Applications

Washlight

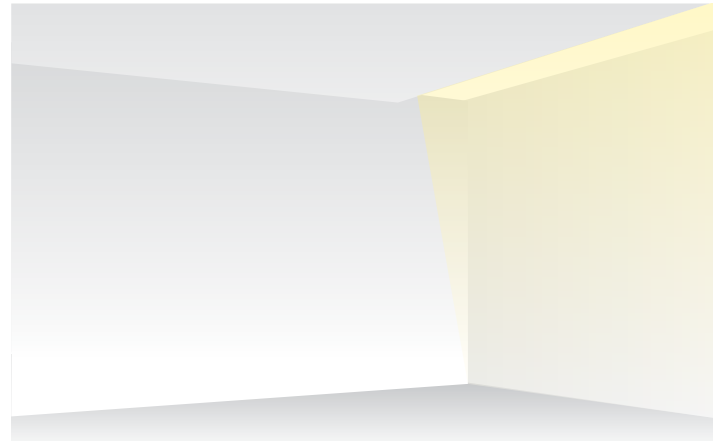

The aim of wall washing, or in fact washing any surface with light (wall, ceiling or floor), is to create an even 'wash' of light across the surface. The wall wash is a great way to introduce light into a room as the brightness of the vertical surfaces around us play a crucial role in our perception of a space.

Use Whitegoods Cove products in a built-out ceiling cove to illuminate the ceiling indirectly and bounce light to the wall - evenly washing the wall and illuminating the space in front of the wall. The Cove hides the source of light and makes the entire wall the feature by evenly illuminating it from above the ceiling plane to the floor, allowing the wall to seemingly appear to extend to infinity above the wall plane.

Products

Edgeless Cove
Mini Edgeless Cove
Box Cove
Mini Box Cove
Box Cove 2
20 Linear Mini Edgeless Cove

Coffer

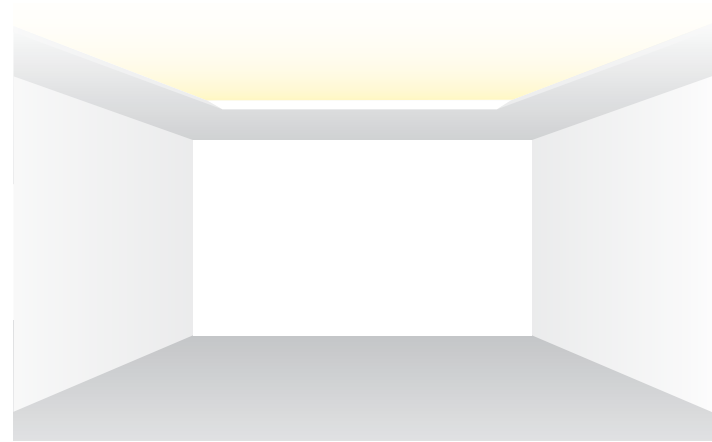

When soft diffuse light comes from above, a natural feel is imparted to a space. It is understandable when you consider that the vast majority of natural light that we experience comes to us from above.

Creating a coffer (inside corners) within the ceiling provides an opportunity to deliver light in this way. Although the technique does require some ceiling depth, it is no more than is typically required for recessed downlights. For example, 4" - 6" between the top of the luminaire and the ceiling is all you need to deliver light to the ceiling and indirect illumination to the space below. Of course, a greater distance such as 8"-12" will deliver the most even illumination to the ceiling.

By integrating the luminaire into the ceiling and hiding the source of light, the occupant of the space realizes a very soothing and glare-free environment. This technique suits hospitality, lobby, conference room, residential and large area settings especially well.

Note that Whitegoods coves are designed to throw low angle light forward into the space, as well as soft illumination above and bounce light behind to evenly illuminate the cove as well.

Products

Edgeless Cove
Mini Edgeless Cove
Box Cove
Mini Box Cove
Box Cove 2
20 Linear Mini Edgeless Cove

Raft (Outside Corners)

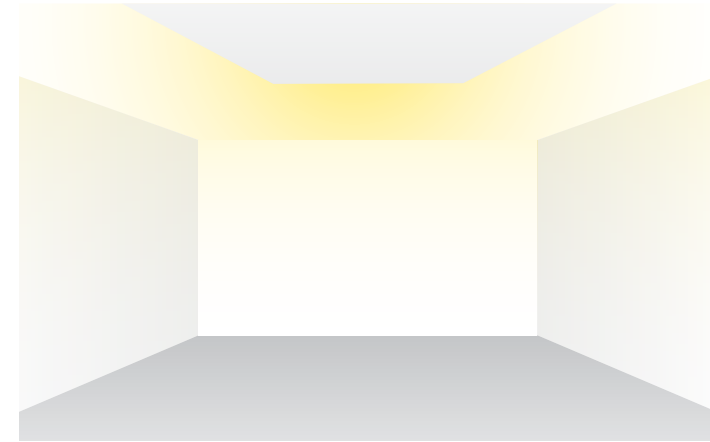

By designing a raft (ceiling cloud) in the middle of a space, the low angle light from a Whitegoods cove product can be used to illuminate the ceiling and redirect light onto adjacent vertical surfaces. A classic way to accentuate the ceiling plane can also illuminate the entire space without glare.

This technique does require some ceiling depth, but is no more than typically required for recessed downlights. For example, 4" - 6" between the top of the luminaire and the ceiling is all you need to deliver light to the ceiling and indirect illumination to the space below. Of course, a greater distance such as 8"-12" will deliver the most even illumination to the ceiling.

By integrating the luminaire into the ceiling and hiding the source of light, the occupant of the space realizes a very soothing and glare-free environment. This technique suits hospitality, lobby, conference room, residential and large area settings especially well.

Products

Edgeless Cove
Mini Edgeless Cove
Box Cove
Mini Box Cove
Box Cove 2
20 Linear Mini Edgeless Cove

Surface Wallmount

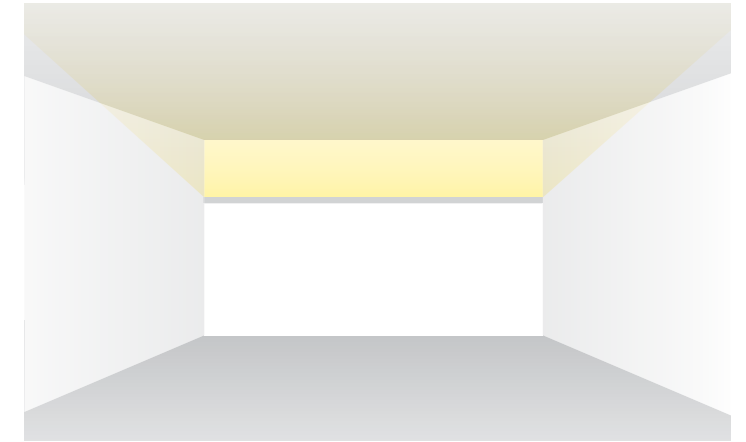

A discrete wall mounted uplight uses the ceiling plane to reflect light evenly into the room, as well as brings volume to the space. When the luminaire is completely indirect, hiding the source of light, and runs wall-to-wall, it creates a dramatic effect delineating the elevation.

Whitegoods uplights throw low angle light far into the room, and a soft fill light above and to the back wall. Special end mounting hardware can be specified for clearspan applications. Box Cove and Box Cove 2 can be mounted directly to a window mullion for a very integrated, minimal appearance in the space.

If you desire a completely glare-free environment that brings volume to the space and mounts to any surface, the Whitegoods wall mounted products are your best bet.

Products

Box Cove
Mini Box Cove
Box Cove 2

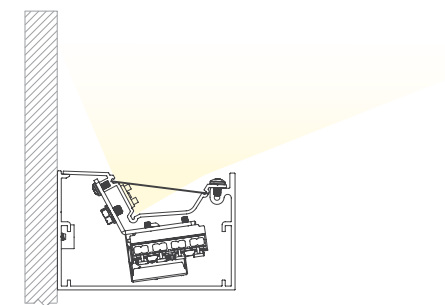
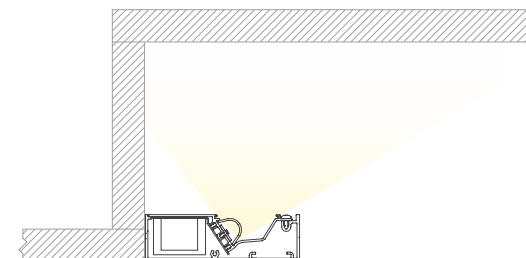
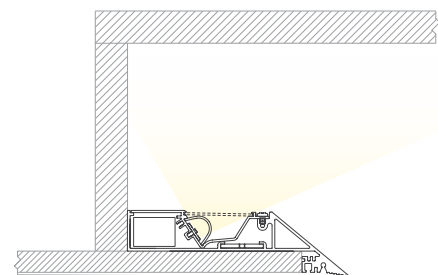
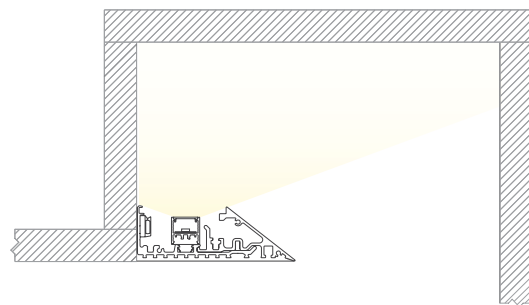

Applications

Concealed Linear Downlight (Floor Wash)

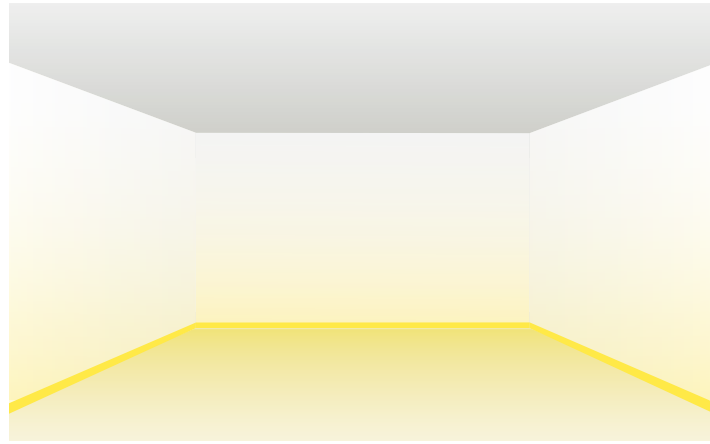

Some spaces do not call for high levels of illumination. Perhaps in a gallery or museum, or a hotel corridor, for example, where the boundaries of a space can be defined by enough light, allowing users to safely navigate their way. Or simply to create a specific atmosphere or mood in a space.

Products
20 Linear Mini Z Cove

Whatever the reason, by stopping the wall short of the floor surface and creating a set back skirting detail, space can be made for linear light sources to be integrated. Recessing the foot of the wall by 2" - 6" creates a gap where light can flow down out of the bottom of the wall and across the floor.

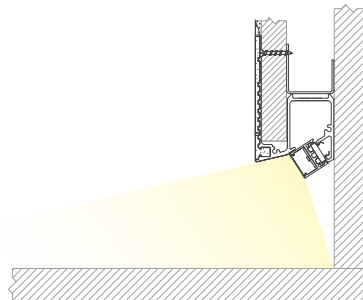

Concealed Linear Uplight (Ceiling Wash)

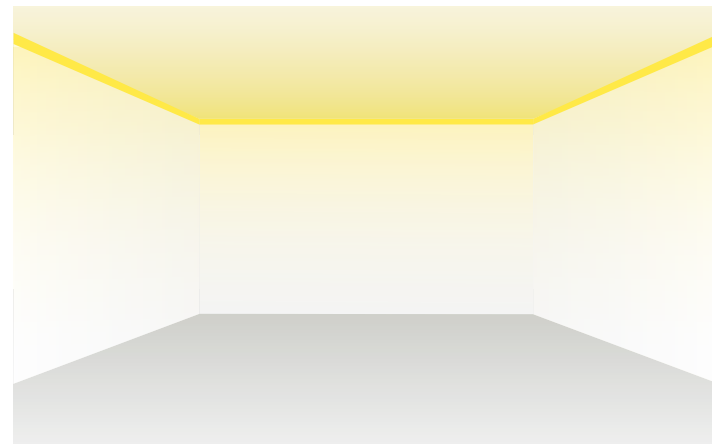

Another simple and highly effective way to deliver natural feeling even light into a space is via a concealed linear light source, detailed into the top edge of a wall surface, just before it meets the ceiling. By virtue of its position, the light source is naturally concealed.

Products
20 Linear Mini Z Cove

The detail is relatively simple to achieve by stopping the wall surface just short of the ceiling (say 6" - 12") and creating a small pocket there at the top of the wall, which can be used to incorporate a luminaire. Some luminaires are very small, less than an inch wide, so the pocket detail does not need to be large.

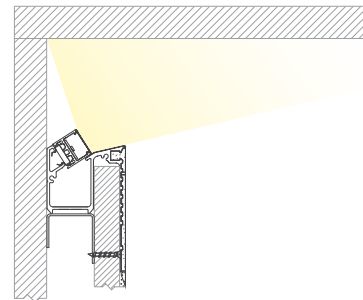

Perimeter

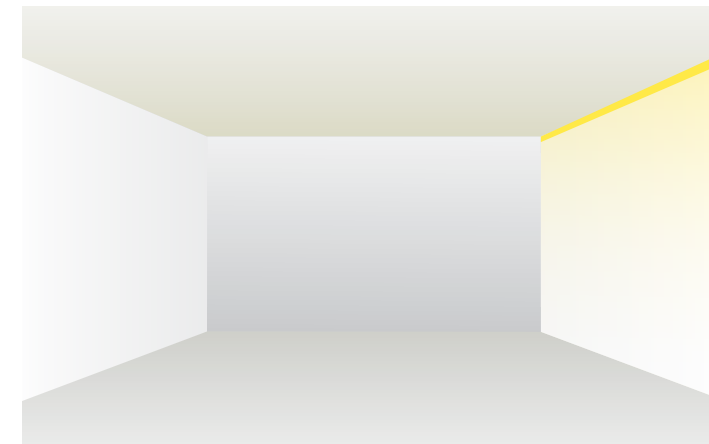

A perimeter lighting system is a significant design element in the space as it creates a focal point for interest or way-finding, and it contributes general illumination to a space.

The light source in a typical perimeter system will originate from above the finished ceiling plane to illuminate the wall from the very top with an even level of illumination, gradually fading as it reaches the floor. Light reflected from the wall will illuminate the space in front of the wall, and often be the only source of light required in spaces such as hallways.

A well designed perimeter lighting system will integrate cleanly into any ceiling type and place the light source in a location where it does not cause a glare nuisance or detract from the visual experience. See Whitegoods various Perimeter systems for a product that meets these requirements, and uses matching LED with all other Whitegoods linear products.

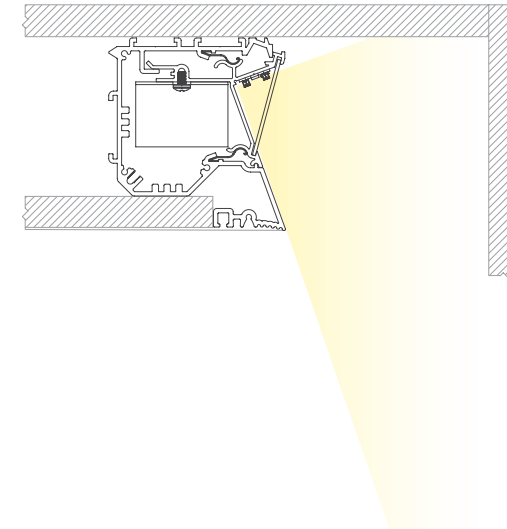

Products
V Cove
Z Cove
20 Linear Mini Z Cove

Configurations

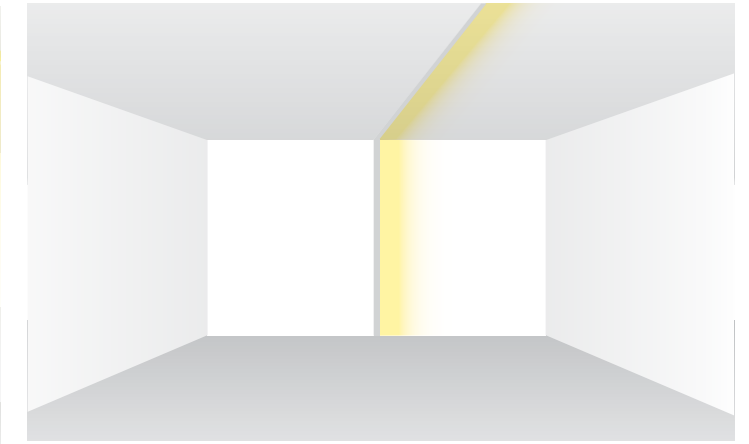

Modular product design, coupled with application engineering support from the Whitegoods team allow your creativity to become reality. If complicated configurations are required to deliver glare-free light into the space and simultaneously create exciting interiors, then a cove configuration may be the solution.

The housing in all Whitegoods products (see 20 Linear, Linear and Downlights) are designed to integrate into the architecture seamlessly, and to accept the gear tray, which holds the electronic power and light source. Providing a product in this manner leaves plenty of room for your imagination. Angles across the wall or ceiling, single or multiple plane configurations, corners of nearly any angle including from wall-to-ceiling or wall-to-wall are possible,

And the light is always hidden from normal view to contribute evenly distributed, glare-free illumination into the space.

Products
Edgeless Cove
Mini Edgeless Cove
20 Linear Mini Edgeless Cove

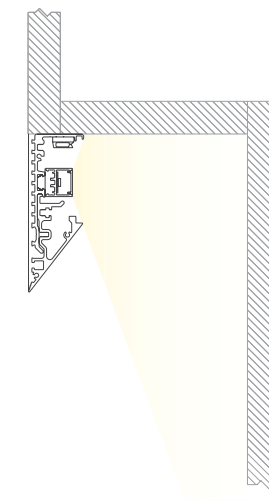

Applications

20 Linear Perimeter Line of Light

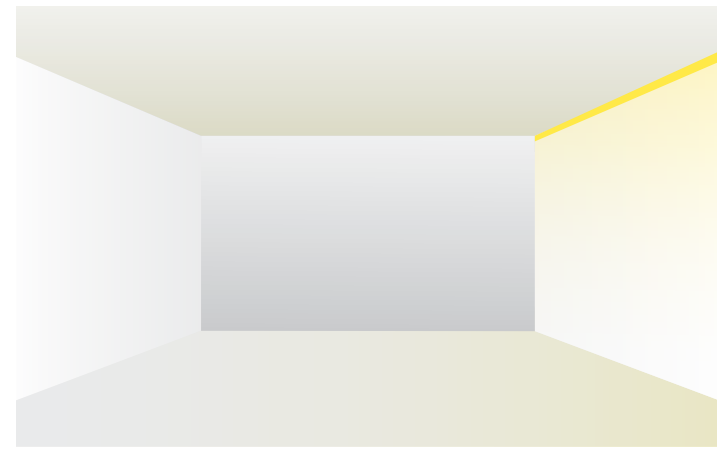

Perimeter lighting is a masterful way to 'float' the ceiling plane off of the wall surface, while concealing the light source and providing usable light to the space.

Another simple and highly effective way to add natural feeling light into a space is via a concealed linear light source detailed into the intersection of the wall and ceiling. This luminaire, typically recessed into the ceiling and providing an even illumination from a homogeneously illuminated lens, gives definition to the space, and functional light to the perimeter.

A perfect application to define lobby and conference space perimeters, as well as vanity light over a mirror by virtue of the fact that the source of light is hidden from normal viewing angles (including mirror reflection), while functional illumination is distributed down the wall and into the space.

Products

- 20 Linear Perimeter Flush
- 20 Linear Perimeter Regressed

20 Linear Perimeter Wall Graze

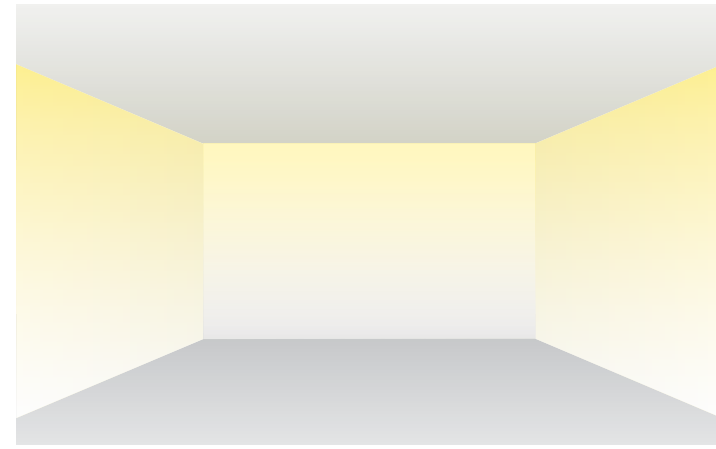

Wall grazing is used to highlight textured walls, such as brick, stone or patterned relief, to provide a focal wall or simply increase the perceived brightness of the space. By recessing the luminaire above the ceiling plane, the entire wall is illuminated and becomes the focal point of the space. Recommended for walls up to 10', applications include lobby and conference space perimeters, as well as vanity light over a mirror by virtue of the fact that the source of light is hidden from normal viewing angles (including mirror reflection), while functional illumination is distributed down the wall and into the space.

The 20 Linear Perimeter, with its minimal aperture provides the perfect detail for perimeter applications while minimizing the effect of the luminaire on the space.

Soft-Graze

This feature simply extends the optic further from the wall, softening the contrast effect on the wall and placing the light down the front of the feature wall.

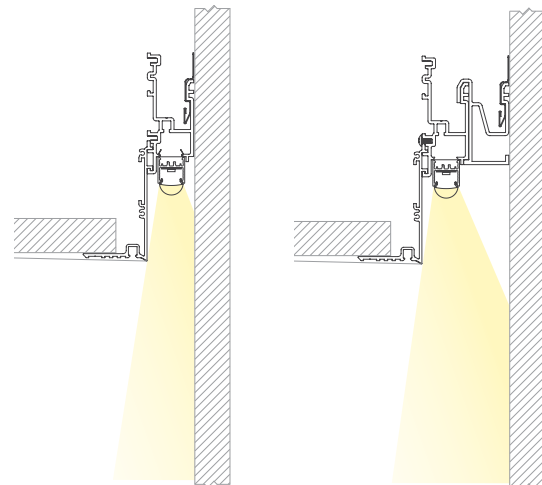

ProTools 60 Linear Perimeter

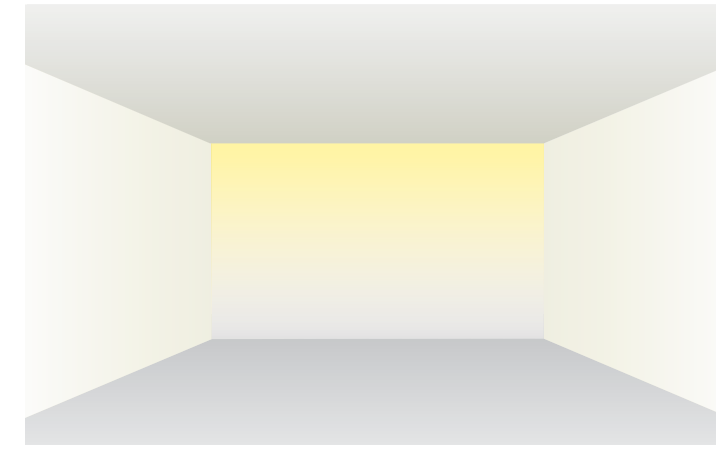

Perimeter lighting is a masterful way to 'float' the ceiling plane off of the wall surface, while concealing the light source and providing usable light to the space. A continuous perimeter lighting system that delivers an even wash of light at the top of the wall, from above the finished ceiling, and gradually diminishes closer to the floor. The Perimeter system can be used to illuminate corridors and provide definition to feature walls.

The micro-prismatic lens delivers even illumination on the wall and floor below. Its high-efficiency coupled with the recessed position make it the most efficient and glare-free way to illuminate the perimeter of a room.

Products

- ProTools 60 Linear Perimeter

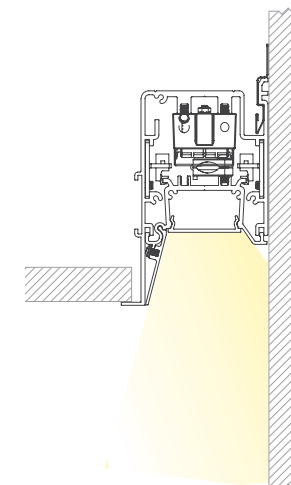

ProTools 60 Linear Wall Graze

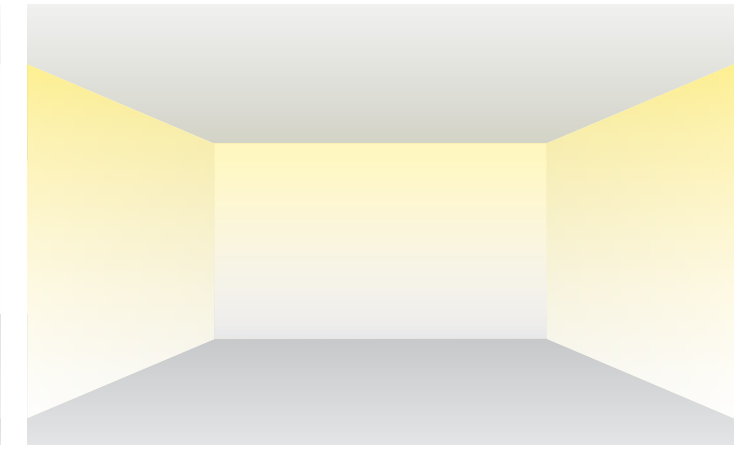

Wall grazing is used to highlight textured walls, such as brick, stone or patterned relief, to provide a focal wall or simply increase the perceived brightness of the space. By adding a tight, elliptical beam to the wall graze distribution, light is driven further down the wall and delivers a sheet of light from above the finished ceiling to the base of the wall. The recessed louver cuts viewing angles to the light source when viewed from any angle, and the choice of low or no brightness finishes on the wall-side reflector ensures that the wall is the brightest object in the space.

Soft-Graze

This feature simply extends the optic further from the wall, softening the contrast effect on the wall and placing the light down the front of the feature wall.

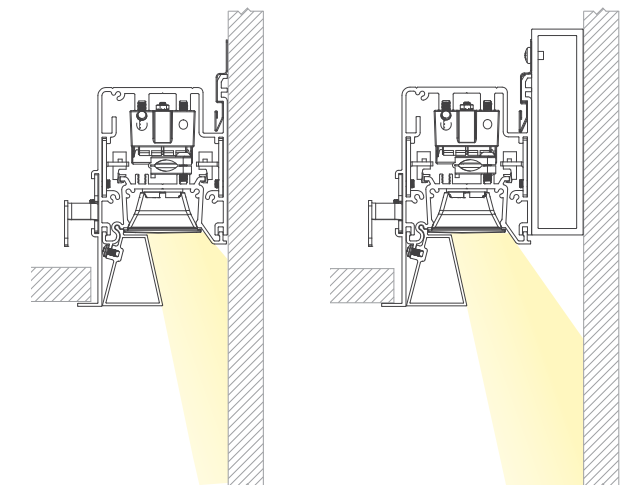



Cove

When soft diffuse light comes from above, a natural feel is imparted to a space. It is understandable when you consider that the vast majority of natural light that we experience comes to us from above. By integrating the luminaire into the ceiling and hiding the source of light, the occupant of the space realizes a very soothing and glare-free environment. This technique suits hospitality, lobby, conference room, residential and large area settings especially well. Note that Whitegoods coves are designed to throw low angle light forward into the space, as well as soft illumination above and bounce light behind to evenly illuminate the cove as well.







Edgeless Cove

The original continuous knife edge cove system featuring plaster-in precision for clean, minimal effect

- Delivers a continuous, even wash of directed light to the ceiling above, and redirected light to softly illuminate the back of the cove.
- Light source positioned for optimum horizontal spread of illumination.
- Light source is not visible from any viewing angle up to and including direct horizontal view.
- Satin Diffuser for high efficiency and soft edge beam without striations.
- Removable light source sub assembly for ease of installation and maintenance.
- High efficiency linear LED in a range of outputs, including static white, tunable white, warm dim and RGBW.
- Integral drivers and through wiring.
- Lengths and angles factory cut to exact field dimensions.
- Mitered and welded corners available with continuous illumination.
- Made in the USA.



Housing Precision extruded aluminum for true dimensions and tolerances
Alignment hardware for invisible seam from below
Housing provided in any exact length
Unitized gear tray with LED and driver for easy final installation
Standard and tailored lengths
Corners: standard and non-standard
Finishes: RAL 9010 white 15% gloss

Integration Seamless, architectural integration into gypsum for minimal visual detail and true knife edge

Distribution Low angle forward throw reflector with max beam at 130 degrees
Back light reflector delivers soft, even illumination to the cove

LED >90 CRI, 3-Step MacAdam, 2700-4000K static white
1.5W - 15W per foot, 180 nominal lumens per watt average, constant current
Tuneable white 2200-4000K, 80 nominal lumens per watt average
Warm Dim to emulate incandescent when dimming; 75 nominal lumens per watt average
RGBW, 50 nominal lumens per watt
L70 (TM21 Projected 85C) Static White / Tunable White = 72,000 hours, RGBW = 50,000 hours, WD = 36,000 hours

Lens SSD - snap-on satin diffuser for high efficiency and soft edge beam without striations.
SDC - satin clear dust cover for wipe down applications

Driver Integral driver
Compatible with quality constant current (Static White / Tunable White) and constant voltage (WD/RGBW) drivers

Connectivity POE
Wireless

Weight 3lbs per foot

Operating Temp Suitable for operation in maximum ambient temperature of 35C (95F)

Warranty 5-year Limited (see complete company warranty information)

Certifications ETL and ETL-C for dry and damp location, CE

Voltages 120-277VAC

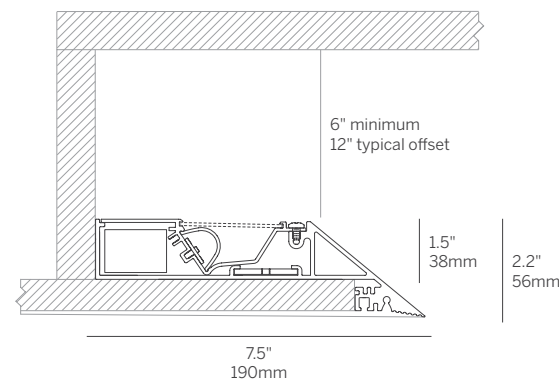

Gypsum Ceiling Mounting

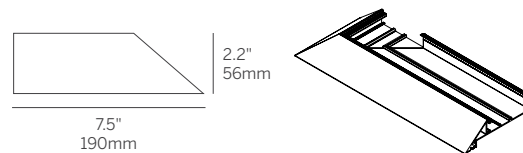

End Caps
EC-LEC/REC

End Wall Returns
EC-LWR/RWR

Edgeless Cove

Model	Fixation	Pattern	Length	Power ³	CRI/ CCT ⁴	Driver ⁶	Lens	Finish ⁷	Options
WG-EC	RPT	S ¹ PC ² PR ² PP ^{1,2} PPO ² PZ ²	A A x B A x B x C A x B x A x B	P0 P1 P2 P3 P4	927 930 935 940 TW ⁵	E1 L1 POE BT DALI TQ	SSD (std) SDC	W (std) F	LEC REC LREC LWR RWR EM
				L M H	WD RGBW	D010 L3DAE L3D0E EL96 DMX			

Model

- WG-EC = Edgeless Cove

Fixation

- RPT = Recessed plaster trim

Pattern

- S = Straight run¹
- PC = Standard patterns coffer 2, 3 or 4 sided with 90° inside corners²
- PR = Standard patterns raft 2, 3 or 4 sided with 90° outside corners²
- PPI = Wall to wall / wall to ceiling, 90° inside corner²
- PPO = Wall to wall / wall to ceiling, 90° outside corner²
- PZ = Non-standard patterns and/or corners other than 90°, consult factory²

Length

- A, B, C = specify inches to the nearest 0.25" (i.e. 72.25") For patterns specify each length (i.e. 2 sided: A x B = 72.25" x 48"; 3 sided: A x B x C; 4 sided: A x B x A x B)

Power³

- P0 = 1.5 W/ft
- P1 = 3 W/ft
- P2 = 6 W/ft
- P3 = 10 W/ft
- P4 = 15 W/ft
- L = 2.7 W/ft WD low power (24V)
- M = 5.5 W/ft WD medium power (24V) [RGBW 7.6 W/ft]
- H = 8W/ft WD high power (24V)

CRI / CCT (90+ CRI minimum)⁴

- 927 = 2700K
- 930 = 3000K
- 935 = 3500K
- 940 = 4000K
- TW = Tunable White 2200K - 4000K⁵
- WD = Warm Dim 1800K-3000K
- RGBW = 3000K White

Driver (integral)⁶

- E1 = eldoLED 0.1% dimming, 0-10V (120-277V)
- L1 = Lutron 1% dimming, EcoSystem (120-277V)
- POE = Power over Ethernet
- BT = Wireless CAS - Casambi (Must specify BT with E1 or DALI)
- DALI = eldoLED DALI DT8 0.1% (120-277V)
- TQ = T-series for Lutron Quantum 0.1% (120-277V) [TW only]
- D010 = Osram, 10%, 0-10V dimming, 120-277V [WD only]
- L3DAE = Lutron Hi-lume 1% EcoSystem, 120-277V [WD only]
- L3D0E = Lutron Hi-lume Premier 0.1% EcoSystem, 120-277V (remote) [WD only]
- DMX = Osram + eldoLED 24V, DMX dimming [WD + RGBW Only]

Lens

- SSD = Snap On Satin Diffuser (standard)
- SDC = Satin Clear Dust Cover

Finish⁷

- W = White, 15% gloss, RAL 9010 / Tiger Drylac 009/10120 (standard)
- F = Custom finish, specify RAL

Options

- LEC = Left end cap
- REC = Right end cap
- LREC = Left & Right end caps
- LWR = Left wall return
- RWR = Right wall return
- EM = Emergency LED driver (remote)

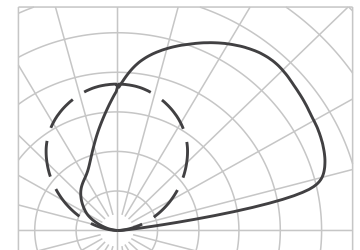

Polar Plot

Whitegoods reserves the right to change any information without prior notice.

Notes

- Standard setup assumes the cove ends at a perpendicular wall and the LED board is setback from the end to minimize light on the perpendicular wall. Contact us for options.
- See pattern specsheet.
- Wattage shown does not include power supplies/drivers.
- Refer to specsheet for delivered lumen data for all product configurations.
- TW offered up to P3 (10W/ft) power level.
- See power supply page for details.
- See Tiger Drylac color chart: inter-lux.com/tiger.

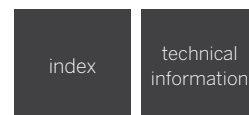

Mini Edgeless Cove

The original continuous linear knife edge cove system featuring plaster-in precision knife edge for clean, minimal effect

- Delivers a continuous, even wash of directed light to the ceiling above, and redirected light to softly illuminate the back of the cove.
- Light source positioned for optimum horizontal spread of illumination.
- Light source is not visible from any viewing angle up to and including direct horizontal view.
- Satin Diffuser for high efficiency and soft edge beam without striations.
- Removable light source sub assembly for ease of installation and maintenance.
- High efficiency linear LED in a range of outputs, including static white, tunable white, warm dim and RGBW.
- Mini size requires remote driver.
- Lengths and angles factory cut to exact field dimensions.
- Mitered and welded corners available with continuous illumination.
- Made in the USA.

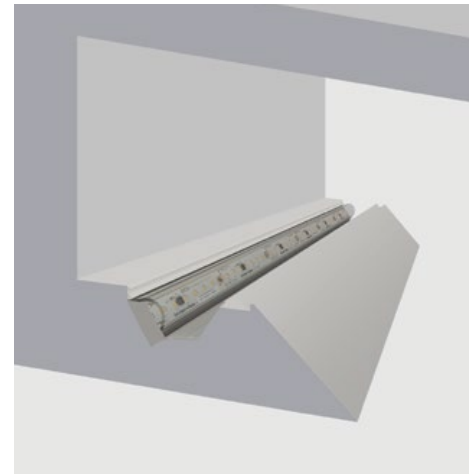

Housing Precision extruded aluminum for true dimensions and tolerances
Alignment hardware for invisible seam from below
Housing provided in any exact length
Unitized gear tray with LEDs for easy final installation
Standard and tailored lengths
Corners: standard and non-standard
Finishes: RAL 9010 white 15% gloss

Integration Seamless, architectural integration into gypsum for minimal visual detail and true knife edge

Distribution Low angle forward throw reflector with max beam at 130 degrees
Back light reflector delivers soft, even illumination to the cove

LED >90 CRI, 3-Step MacAdam, 2700-4000K static white
1.5W - 15W per foot, 180 nominal lumens per watt average, constant current
Tunable white 2200-4000K, 80 nominal lumens per watt average
Warm Dim to emulate incandescent when dimming; 75 nominal lumens per watt average
RGBW, 50 nominal lumens per watt
L70 (TM21 Projected 85C) Static White / Tunable White = 72,000 hours, RGBW = 50,000 hours, WD = 36,000 hours

Lens SSD - snap-on satin diffuser for high efficiency and soft edge beam without striations.
SDC - satin clear dust cover for wipe down applications

Driver Remote driver
Compatible with quality constant current (Static White / Tunable White) and constant voltage (WD / RGBW) drivers

Connectivity POE
Wireless

Weight 2lbs per foot

Operating Temp Suitable for operation in maximum ambient temperature of 35C (95F)

Warranty 5-year Limited (see complete company warranty information)

Certifications ETL and ETL-C for dry and damp location, CE

Voltages Low Voltage Fixture, 120-277VAC Driver (remote)

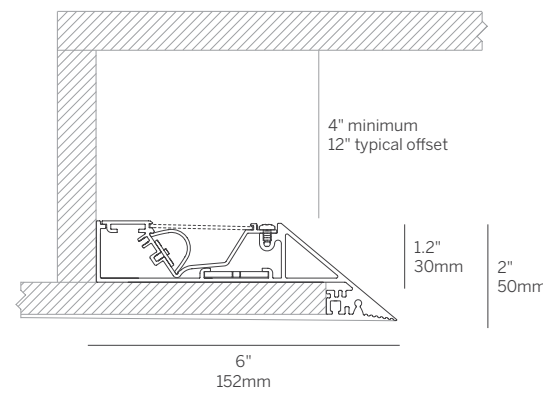

Gypsum Ceiling Mounting

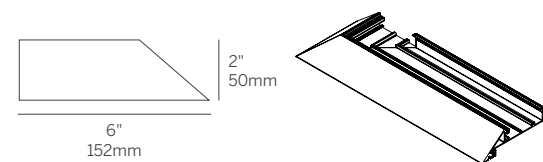

End Caps
MEC-LEC/REC

End Wall Returns
MEC-LWR/RWR

Mini Edgeless Cove

Model	Fixation	Pattern	Length	Power ³	CRI/CCT ⁴	Driver ⁶	Lens	Finish ⁷	Options
WG-MEC	RPT	S ¹ PC ² PR ² PPI ² PPO ² PZ ²	A A x B A x B x C A x B x A x B	P0 P1 P2 P3 P4	927 930 935 940 TW ⁵	E1 L1 POE BT DALI TQ	SSD (std) SDC	W (std) F	LEC REC LREC LWR RWR EM
				L M H	WD RGBW	D010 DPH L3DAE L3D0E EL96 DMX			

Model

- WG-MEC = Mini Edgeless Cove

Fixation

- RPT = Recessed plaster trim

Pattern

- S = Straight run¹
- PC = Standard patterns coffer 2, 3 or 4 sided with 90° inside corners²
- PR = Standard patterns raft 2, 3 or 4 sided with 90° outside corners²
- PPI = Wall to wall / wall to ceiling, 90° inside corner²
- PPO = Wall to wall / wall to ceiling, 90° outside corner²
- PZ = Non-standard patterns and/or corners other than 90°, consult factory²

Length

- A, B, C = specify inches to the nearest 0.25" (i.e. 72.25") For patterns specify each length (i.e. 2 sided: A x B = 72.25" x 48"; 3 sided: A x B x C; 4 sided: A x B x A x B)

Power³

- P0 = 1.5 W/ft
- P1 = 3 W/ft
- P2 = 6 W/ft
- P3 = 10 W/ft
- P4 = 15 W/ft
- L = 2.7 W/ft WD low power (24V)
- M = 5.5 W/ft WD medium power (24V) [RGBW 7.6 W/ft]
- H = 8W/ft WD high power (24V)

CRI / CCT (90+ CRI minimum)⁴

- 927 = 2700K
- 930 = 3000K
- 935 = 3500K
- 940 = 4000K
- TW = Tunable White 2200K - 4000K⁵
- WD = Warm Dim 1800K-3000K
- RGBW = 3000K White

Driver (remote)⁶

- E1 = eldoLED 0.1% dimming, 0-10V (120-277V)
- L1 = Lutron 1% dimming, EcoSystem (120-277V)
- POE = Power over Ethernet
- BT = Wireless CAS - Casambi (Must specify BT with E1 or DALI)
- DALI = eldoLED DALI DT8 0.1% (120-277V)
- TQ = T-series for Lutron Quantum 0.1% (120-277V) [TW only]
- D010 = Osram, 10%, 0-10V dimming, 120-277V [WD only]
- DPH = Phase Dimming, 1% dimming, 120V only [WD only]
- L3DAE = Lutron Hi-lume 1% EcoSystem, 120-277V [WD only]
- L3D0E = Lutron Hi-lume Premier 0.1% EcoSystem, 120-277V (remote) [WD only]
- DMX = Osram + eldoLED 24V, DMX dimming [WD + RGBW Only]

Lens

- SSD = Snap On Satin Diffuser (standard)
- SDC = Satin Clear Dust Cover

Finish⁷

- W = White, 15% gloss, RAL 9010 / Tiger Drylac 009/10120 (standard)
- F = Custom finish, specify RAL

Options

- LEC = Left end cap
- REC = Right end cap
- LREC = Left & Right end caps
- LWR = Left wall return
- RWR = Right wall return
- EM = Emergency LED driver (remote)

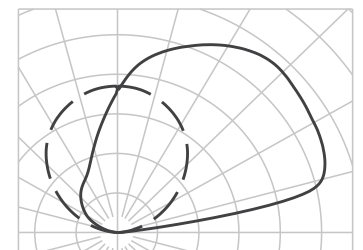

Polar Plot

Whitegoods reserves the right to change any information without prior notice.

Notes

- Standard setup assumes the cove ends at a perpendicular wall and the LED board is setback from the end to minimize light on the perpendicular wall. Contact us for options.
- See pattern specsheet.
- Wattage shown does not include power supplies/drivers.
- Refer to specsheet for delivered lumen data for all product configurations.
- TW offered up to P3 (10W/ft) power level.
- See power supply page for details.
- See Tiger Drylac color chart: inter-lux.com/tiger.

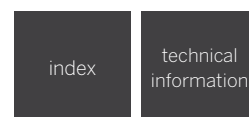

Box Cove

Classic square-fronted continuous linear cove system for clean, minimal effect with optimized distribution for maximum throw of light

- Light source positioned for optimum horizontal spread of illumination.
- Light source is not visible from any viewing angle up to and including direct horizontal view.
- Delivers continuous soft wash of directed light to above surface.
- Satin Diffuser for high efficiency and soft edge beam without striations.
- Removable light source sub assembly for ease of installation and maintenance.
- High efficiency linear LED in a range of outputs, including static white, tunable white, warm dim and RGBW.
- Integral drivers and through wiring.
- Lengths and angles factory cut to exact field dimensions.
- Mitered and welded corners available with continuous illumination.
- Made in the USA.



Housing Precision extruded aluminum for true dimensions and tolerances
Alignment hardware for invisible seam from below
Housing provided in any exact length
Unitized gear tray with LED and driver for easy final installation
Standard and tailored lengths
Corners: standard and non-standard
Finishes: RAL 9010 white 15% gloss

Integration Fixation to any vertical surface or horizontal surface

Distribution Low angle forward throw reflector with max beam at 130 degrees
Back light reflector delivers soft, even illumination to the cove

LED >90 CRI, 3-Step MacAdam, 2700-4000K static white
1.5W - 15W per foot, 180 nominal lumens per watt average, constant current
Tuneable white 2200-4000K, 80 nominal lumens per watt average
Warm Dim to emulate incandescent when dimming; 75 nominal lumens per watt average
RGBW, 50 nominal lumens per watt
L70 (TM21 Projected 85C) Static White / Tunable White = 72,000 hours,
RGBW = 50,000 hours, WD = 36,000 hours

Lens SSD - snap-on satin diffuser for high efficiency and soft edge beam without striations.
SDC - satin clear dust cover for wipe down applications

Driver Integral driver
Compatible with quality constant current (Static White / Tunable White) and constant voltage (WD / RGBW) drivers

Connectivity POE
Wireless

Weight 3lbs per foot

Operating Temp Suitable for operation in maximum ambient temperature of 35C (95F)

Warranty 5-year Limited (see complete company warranty information)

Certifications ETL and ETL-C for dry and damp location, CE

Voltages 120-277VAC

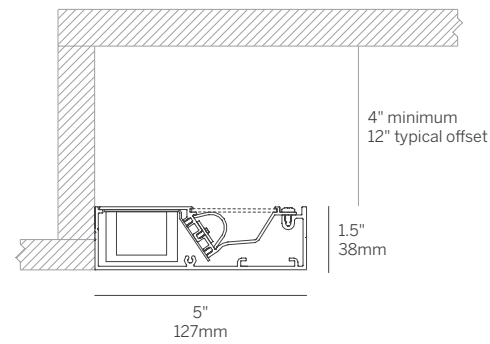

Surface Wall

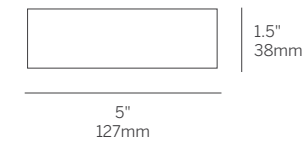

End Caps

BC-LEC/REC

Box Cove

Model	Fixation	Pattern	Length	Power ³	CRI/CCT ⁴	Driver ⁶	Lens ⁷	Finish	Options
WG-BC	SW SWM	S ¹ PC ² PR ² PPI ² PPO ² PZ ²	A A x B A x B x C A x B x A x B	P0	927	E1	SSD (std) SDC	W (std) F	LEC REC LREC EM
				P1 P2 P3 P4	930 935 940 TW ⁵	L1 POE BT DALI TQ			
				L M H	WD RGBW	D010 L3DAE L3DOE EL96 DMX			

Model

- WG-BC = Box Cove

Fixation

- SW = Surface Wall Mount
- SWM = Surface Wall Mullion Mount

Pattern

- S = Straight run¹
- PC = Standard patterns coffer 2, 3 or 4 sided with 90° inside corners²
- PR = Standard patterns raft 2, 3 or 4 sided with 90° outside corners²
- PPI = Wall to wall / wall to ceiling, 90° inside corner²
- PPO = Wall to wall / wall to ceiling, 90° outside corner²
- PZ = Non-standard patterns and/or corners other than 90°, consult factory²

Length

- A, B, C = specify inches to the nearest 0.25" (i.e. 72.25") For patterns specify each length (i.e. 2 sided: A x B = 72.25" x 48"; 3 sided: A x B x C; 4 sided: A x B x A x B)

Power³

- P0 = 1.5 W/ft
- P1 = 3 W/ft
- P2 = 6 W/ft
- P3 = 10 W/ft
- P4 = 15 W/ft
- L = 2.7 W/ft WD low power (24V)
- M = 5.5 W/ft WD medium power (24V) [RGBW 7.6 W/ft]
- H = 8W/ft WD high power (24V)

CRI / CCT (90+ CRI minimum)⁴

- 927 = 2700K
- 930 = 3000K
- 935 = 3500K
- 940 = 4000K
- TW = Tunable White 2200K - 4000K⁵
- WD = Warm Dim 1800K-3000K
- RGBW = 3000K White

Driver (integral)⁶

- E1 = eldoLED 0.1% dimming, 0-10V (120-277V)
- L1 = Lutron 1% dimming, EcoSystem (120-277V)
- POE = Power over Ethernet
- BT = Wireless CAS - Casambi (Must specify BT with E1 or DALI)
- DALI = eldoLED DALI DT8 0.1% (120-277V)
- TQ = T-series for Lutron Quantum 0.1% (120-277V) [TW only]
- D010 = Osram, 10%, 0-10V dimming, 120-277V [WD only]
- L3DAE = Lutron Hi-lume 1% EcoSystem, 120-277V [WD only]
- L3DOE = Lutron Hi-lume Premier 0.1% EcoSystem, 120-277V (remote) [WD only]
- DMX = Osram + eldoLED 24V, DMX dimming [WD + RGBW Only]

Lens

- SSD = Snap On Satin Diffuser (standard)
- SDC = Satin Clear Dust Cover

Finish⁷

- W = White, 15% gloss, RAL 9010 / Tiger Drylac 009/10120 (standard)
- F = Custom finish, specify RAL

Options

- LEC = Left end cap
- REC = Right end cap
- LREC = Left & Right end caps
- EM = Emergency LED driver (remote)

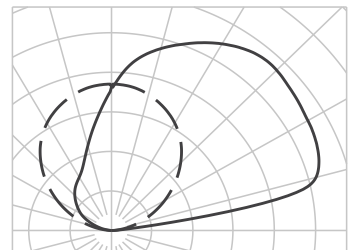

Polar Plot

Whitegoods reserves the right to change any information without prior notice.

Notes

- Standard setup assumes the cove ends at a perpendicular wall and the LED board is setback from the end to minimize light on the perpendicular wall. Contact us for options.
- See pattern specs sheet.
- Wattage shown does not include power supplies/drivers.
- Refer to specs sheet for delivered lumen data for all product configurations.
- TW offered up to P3 (10W/ft) power level.
- See power supply page for details.
- See Tiger Drylac color chart: inter-lux.com/tiger.

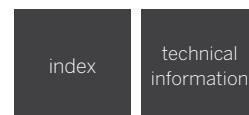

Mini Box Cove

Classic square-fronted continuous linear cove system for clean, minimal effect with optimized distribution for maximum throw of light from a small luminaire

- Light source positioned for optimum horizontal spread of illumination.
- Light source is not visible from any viewing angle up to and including direct horizontal view.
- Delivers continuous soft wash of directed light to above surface.
- Satin Diffuser for high efficiency and soft edge beam without striations.
- Removable light source sub assembly for ease of installation and maintenance.
- High efficiency linear LED in a range of outputs, including static white, tunable white, warm dim and RGBW.
- Mini size requires remote driver.
- Lengths and angles factory cut to exact field dimensions.
- Mitered and welded corners available with continuous illumination.
- Made in the USA.



Housing Precision extruded aluminum for true dimensions and tolerances
Alignment hardware for invisible seam from below
Housing provided in any exact length
Unitized gear tray with LEDs for easy final installation
Standard and tailored lengths
Corners: standard and non-standard
Finishes: RAL 9010 white 15% gloss

Integration Fixation to any vertical surface or horizontal surface

Distribution Low angle forward throw reflector with max beam at 130 degrees
Back light reflector delivers soft, even illumination to the cove

LED >90 CRI, 3-Step MacAdam, 2700-4000K static white
1.5W - 15W per foot, 180 nominal lumens per watt average, constant current
Tuneable white 2200-4000K, 80 nominal lumens per watt average
Warm Dim to emulate incandescent when dimming; 75 nominal lumens per watt average
RGBW, 50 nominal lumens per watt
L70 (TM21 Projected 85C) Static White / Tunable White = 72,000 hours,
RGBW = 50,000 hours, WD = 36,000 hours

Lens SSD - snap-on satin diffuser for high efficiency and soft edge beam without striations.
SDC - satin clear dust cover for wipe down applications

Driver Remote driver
Compatible with quality constant current (Static White / Tunable White) and constant voltage (WD / RGBW) drivers

Connectivity POE
Wireless

Weight 2lbs per foot

Operating Temp Suitable for operation in maximum ambient temperature of 35C (95F)

Warranty 5-year Limited (see complete company warranty information)

Certifications ETL and ETL-C for dry and damp location, CE

Voltages Low Voltage Fixture, 120-277VAC Driver (remote)

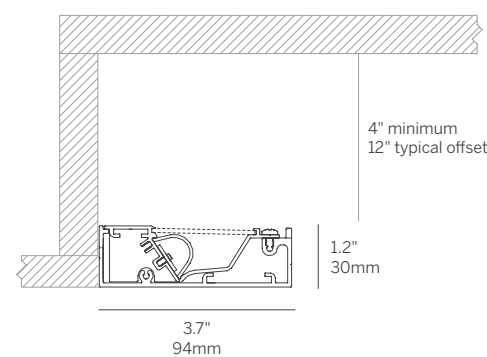

Surface Wall

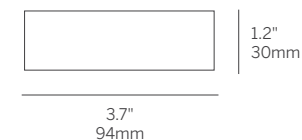

End Caps
MBC-LEC/REC

Mini Box Cove

Model	Fixation	Pattern	Length	Power ³	CRI/CCT ⁴	Driver ⁶	Lens	Finish ⁷	Options
WG-MBC	SW	S ¹ PC ² PR ² PPI ² PPO ² PZ ²	A A x B A x B x C A x B x A x B	P0	927	E1	SSD (std) SDC	W (std) F	LEC REC LREC EM
				P1	930	L1			
				P2	935	POE			
				P3	940	BT			
				P4	TW ⁵	DALI TQ			
				L M H	WD RGBW	D010 DPH L3DAE L3D0E EL96 DMX			

Model

- WG-BC = Mini Box Cove

Fixation

- SW = Surface Wall Mount

Pattern

- S = Straight run¹
- PC = Standard patterns coffer 2, 3 or 4 sided with 90° inside corners²
- PR = Standard patterns raft 2, 3 or 4 sided with 90° outside corners²
- PPI = Wall to wall / wall to ceiling, 90° inside corner²
- PPO = Wall to wall / wall to ceiling, 90° outside corner²
- PZ = Non-standard patterns and/or corners other than 90°, consult factory²

Length

- A, B, C = specify inches to the nearest 0.25" (i.e. 72.25") For patterns specify each length (i.e. 2 sided: A x B = 72.25" x 48"; 3 sided: A x B x C; 4 sided: A x B x A x B)

Power³

- P0 = 1.5 W/ft
- P1 = 3 W/ft
- P2 = 6 W/ft
- P3 = 10 W/ft
- P4 = 15 W/ft
- L = 2.7 W/ft WD low power (24V)
- M = 5.5 W/ft WD medium power (24V) [RGBW 7.6 W/ft]
- H = 8W/ft WD high power (24V)

CRI / CCT (90+ CRI minimum)⁴

- 927 = 2700K
- 930 = 3000K
- 935 = 3500K
- 940 = 4000K
- TW = Tunable White 2200K - 4000K⁵
- WD = Warm Dim 1800K-3000K
- RGBW = 3000K White

Driver (Remote)⁶

- E1 = eldoLED 0.1% dimming, 0-10V (120-277V)
- L1 = Lutron 1% dimming, EcoSystem (120-277V)
- POE = Power over Ethernet
- BT = Wireless CAS - Casambi (Must specify BT with E1 or DALI)
- DALI = eldoLED DALI DT8 0.1% (120-277V)
- TQ = T-series for Lutron Quantum 0.1% (120-277V) [TW only]
- D010 = Osram, 10%, 0-10V dimming, 120-277V [WD only]
- DPH = Phase Dimming, 1% dimming, 120V only [WD only]
- L3DAE = Lutron Hi-lume 1% EcoSystem, 120-277V [WD only]
- L3D0E = Lutron Hi-lume Premier 0.1% EcoSystem, 120-277V (remote) [WD only]
- DMX = Osram + eldoLED 24V, DMX dimming [WD + RGBW Only]

Lens

- SSD = Snap On Satin Diffuser (standard)
- SDC = Satin Clear Dust Cover

Finish⁷

- W = White, 15% gloss, RAL 9010 / Tiger Drylac 009/10120 (standard)
- F = Custom finish, specify RAL

Options

- LEC = Left end cap
- REC = Right end cap
- LREC = Left & Right end caps
- EM = Emergency LED driver (remote)

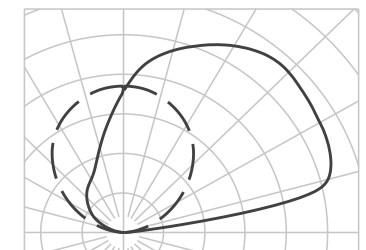

Polar Plot

Whitegoods reserves the right to change any information without prior notice.

Notes

- Standard setup assumes the cove ends at a perpendicular wall and the LED board is setback from the end to minimize light on the perpendicular wall. Contact us for options.
- See pattern specsheet.
- Wattage shown does not include power supplies/drivers.
- Refer to specsheet for delivered lumen data for all product configurations.
- TW offered up to P3 (10W/ft) power level.
- See power supply page for details.
- See Tiger Drylac color chart: inter-lux.com/tiger.

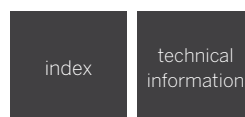

Box Cove 2

Classic square-fronted continuous linear interior wall and mullion mount for clean, minimal effect with optimized distribution for maximum throw of light

- Absolute minimal sized wall-mounted indirect luminaire with high-performance optics and integral driver.
- Reflector positioned for optimum horizontal spread of light.
- Light source is not visible from any viewing angle up to and including direct horizontal view.
- Delivers continuous soft wash of directed light to the surface above.
- Satin Diffuser for high efficiency and soft edge beam without striations.
- Removable light source sub assembly for ease of installation and maintenance.
- High efficiency linear LED in a range of outputs, including static white, tunable white, warm dim and RGBW.
- Integral drivers and through wiring.
- Lengths and angles factory cut to exact field dimensions.
- Mitered and welded corners available with continuous illumination.
- Made in the USA.

Housing Precision extruded aluminum for true dimensions and tolerances
Alignment hardware for invisible seam from below
Housing provided in any exact length
Wall, end-wall and mullion mount with rear and end feed options
Mounts over a horizontal switch box or direct conduit connection
Unitized gear tray with LED and driver for easy final installation
Standard and tailored lengths
Corners: standard and non-standard
Finishes: RAL 9010 white 15% gloss, Satin Aluminum, Dark Bronze

Integration Surface mounted to any vertical surface wall or mullion

Distribution Low angle forward throw reflector with max beam at 130 degrees
Back light reflector delivers soft, even illumination to the ceiling and back wall

LED >90 CRI, 3-Step MacAdam, 2700-4000K static white
1.5W - 15W per foot, 180 nominal lumens per watt average, constant current
Tuneable white 2200-4000K, 80 nominal lumens per watt average
Warm Dim to emulate incandescent when dimming; 75 nominal lumens per watt average
RGBW, 50 nominal lumens per watt
L70 (TM21 Projected 85C) Static White / Tunable White = 72,000 hours,
RGBW = 50,000 hours, WD = 36,000 hours

Lens SSD - snap-on satin diffuser for high efficiency and soft edge beam without striations.
SDC - satin clear dust cover for wipe down applications

Driver Integral driver
Compatible with quality constant current (Static White / Tunable White) and constant voltage (WD / RGBW) drivers

Connectivity POE
Wireless

Weight 3lbs per foot

Operating Temp Suitable for operation in maximum ambient temperature of 35C (95F)

Warranty 5-year Limited (see complete company warranty information)

Certifications ETL and ETL-C for dry and damp location, CE

Voltages 120-277VAC, WD / RGBW - Low Voltage Fixture, 120-277VAC Driver (remote)

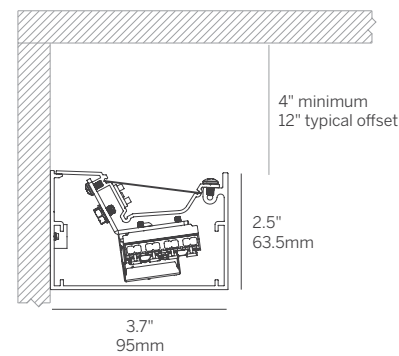

Shown with Satin Clear Dust Cover (SDC)

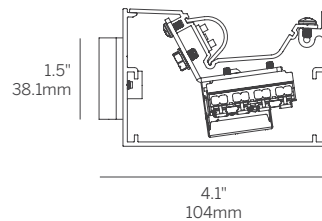

Shown with optional Surface Wall Mullion Mount (SWM) with Snap On Satin Diffuser (SSD)

Box Cove 2

Model	Fixation	Pattern	Length	Power ³	CRI/ CCT ⁴	Driver ⁵	Lens	Finish ⁷	Options
WG-BC2	SW SWM	S ¹ PC ² PR ² PPI ² PPO ² PZ ²	24 36 48 72 96 XX	P0	927	E1	SSD (std) SDC	W B S DB F	EWM EM
				P1	930	L1			
				P2	935	POE			
				P3	940	BT			
				P4	TW ⁵	DALI TQ			
				L M H	WD RGBW	D010 L3DAE L3DOE EL96 DMX			

Model

- WG-BC2 = Box Cove 2

Fixation

- SW = Surface Wall Mount
- SWM = Surface Wall Mullion Mount

Pattern

- S = Straight run¹
- PC = Standard patterns coffer 2, 3 or 4 sided with 90° inside corners²
- PR = Standard patterns raft 2, 3 or 4 sided with 90° outside corners²
- PPI = Wall to wall / wall to ceiling, 90° inside corner²
- PPO = Wall to wall / wall to ceiling, 90° outside corner²
- PZ = Non-standard patterns and/or corners other than 90°; consult factory²

Length

- 24 = 24"
- 36 = 36"
- 48 = 48"
- 72 = 72"
- 96 = 96"
- XX = Specify inches to the nearest 0.25"

Power³

- P0 = 1.5 W/ft
- P1 = 3 W/ft
- P2 = 6 W/ft
- P3 = 10 W/ft
- P4 = 15 W/ft
- L = 2.7 W/ft WD low power (24V)
- M = 5.5 W/ft WD medium power (24V) [RGBW 7.6 W/ft]
- H = 8W/ft WD high power (24V)

CRI / CCT (90+ CRI minimum)⁴

- 927 = 2700K
- 930 = 3000K
- 935 = 3500K
- 940 = 4000K
- TW = Tunable White 2200K - 4000K⁵
- WD = Warm Dim 1800K-3000K
- RGBW = 3000K White

Driver (integral)⁶

- E1 = eldoLED 0.1% dimming, 0-10V (120-277V)
- L1 = Lutron 1% dimming, EcoSystem (120-277V)
- POE = Power over Ethernet
- BT = Wireless CAS - Casambi (Must specify BT with E1 or DALI)
- DALI = eldoLED DALI DT8 0.1% (120-277V)
- TQ = T-series for Lutron Quantum 0.1% (120-277V) [TW only]
- D010 = Osram, 10%, 0-10V dimming, 120-277V [WD only] (remote)
- L3DAE = Lutron Hi-lume 1% EcoSystem, 120-277V [WD only] (remote)
- L3DOE = Lutron Hi-lume Premier 0.1% EcoSystem, 120-277V (remote) [WD only] (remote)
- DMX = Osram + eldoLED 24V, DMX dimming [WD + RGBW Only] (remote)

Lens

- SSD = Snap On Satin Diffuser (standard)
- SDC = Satin Clear Dust Cover

Finish⁷

- W = White, 15% gloss, RAL 9003 / Tiger Drylac 049/11350 (standard)
- B = Black, 15% gloss, RAL 9005 / Tiger Drylac 049/90053
- S = Silver, 15% gloss, RAL 9006 / Tiger Drylac 049/90500
- DB = Dark Bronze (contact factory)
- F = Custom finish, specify RAL

Options

- EWM = End Wall Mount
- EM = Emergency LED driver (remote)

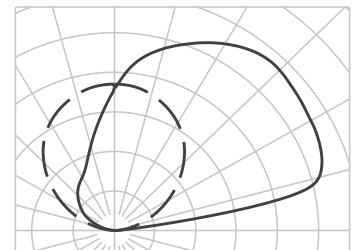

Polar Plot

Whitegoods reserves the right to change any information without prior notice.

Notes

- Standard setup assumes the cove ends at a perpendicular wall and the LED board is setback from the end to minimize light on the perpendicular wall. Contact us for options.
- See pattern specsheet.
- Wattage shown does not include power supplies/drivers.
- Refer to specsheet for delivered lumen data for all product configurations.
- TW offered up to P3 (10W/ft) power level.
- See power supply page for details.
- See Tiger Drylac color chart: inter-lux.com/tiger.

20 Linear Mini Edgeless Cove

Compact but highly effective indirect cove system featuring a plaster trim precision knife edge for clean, minimal effect, fully concealing the light source

- Extremely small knife-edge cove utilizing the 20Linear for general indirect distribution.
- Continuous mounting to any desired length.
- Luminaire has opal or satin diffuser options for even illumination, elimination of glare and high efficiency.
- Lengths and angles factory cut to exact field dimensions - housing may be field cut.
- Removable light source sub assembly for ease of installation and maintenance.
- High efficiency linear LED in a range of outputs, including static white, tunable white, warm dim and RGBW.
- Mini size requires remote driver.
- Lengths and angles factory cut to exact field dimensions.
- Mitered corners available with continuous illumination.
- Made in the USA.



Housing Precision extruded aluminum for true dimensions and tolerances
Alignment hardware for invisible seam from below
Housing provided in any exact length, or field cut
Snap-in LED insert for easy installation
Standard and tailored lengths
Corners: standard and non-standard
Finishes: RAL 9010 white 15% gloss

Integration Seamless, architectural integration into gypsum for minimal visual detail and true knife edge

Distribution Wide indirect distribution fully illuminates the cove and redirects light into the adjacent space

LED >90 CRI, 3-Step MacAdam, 2700-4000K static white
1.5W - 10W per foot, 180 nominal lumens per watt average, constant current
Tuneable white 2200-4000K, 80 nominal lumens per watt average
Warm Dim to emulate incandescent when dimming; 75 nominal lumens per watt average
RGBW, 50 nominal lumens per watt
L70 (TM21 Projected 85C) Static White / Tunable White = 72,000 hours, RGBW = 50,000 hours, WD = 36,000 hours

Lens SD - satin clear dust cover for wipe down applications
OD - Opal diffuser provides even, continuous line of light and general illumination

Driver Remote driver
Compatible with quality constant current (Static White / Tunable White) and constant voltage (WD / RGBW) drivers

Connectivity POE
Wireless

Weight 1lb per foot

Operating Temp Suitable for operation in maximum ambient temperature of 35C (95F)

Warranty 5-year Limited (see complete company warranty information)

Certifications ETL and ETL-C for dry and damp location, CE

Voltages Low Voltage Fixture, 120-277VAC Driver (remote)

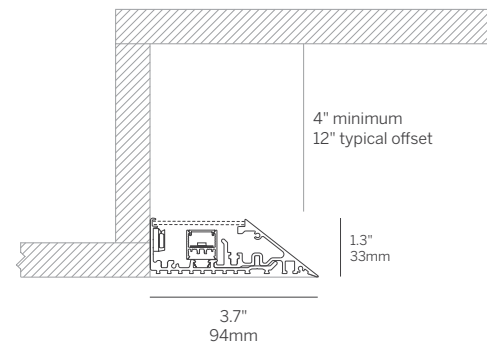

Gypsum Ceiling Mounting Options

20 Linear Mini Edgeless Cove

Model	Fixation	Pattern	Length	Power ³	CRI/ CCT ⁴	Driver ⁶	Lens	Finish ⁷	Options
WG-20MEC	RPT	S ¹ PC ² PR ² PPI ² PPO ² PZ ²	A A x B A x B x C A x B x A x B	P0 P1 P2 P3 L M H	927 930 935 940 TW ⁵	E1 L1 POE BT DALI TQ	SD (std) OD	W (std) F	CDC EM
					WD RGBW	D010 DPH L3DAE L3D0E EL96 DMX			

Model

- WG-20MEC = Mini Edgeless Cove

Fixation

- RPT = Recessed plaster trim

Pattern

- S = Straight run¹
- PC = Standard patterns coffer 2, 3 or 4 sided with 90° inside corners²
- PR = Standard patterns raft 2, 3 or 4 sided with 90° outside corners²
- PPI = Wall to wall / wall to ceiling, 90° inside corner²
- PPO = Wall to wall / wall to ceiling, 90° outside corner²
- PZ = Non-standard patterns and/or corners other than 90°, consult factory²

Length

- A, B, C = specify inches to the nearest 0.25" (i.e. 72.25") For patterns specify each length (i.e. 2 sided: A x B = 72.25" x 48"; 3 sided: A x B x C; 4 sided: A x B x A x B)

Power³

- P0 = 1.5 W/ft
- P1 = 3 W/ft
- P2 = 6 W/ft
- P3 = 10 W/ft
- L = 2.7 W/ft WD low power (24V)
- M = 5.5 W/ft WD medium power (24V) [RGBW 7.6 W/ft]
- H = 8W/ft WD high power (24V)

CRI / CCT (90+ CRI minimum)⁴

- 927 = 2700K
- 930 = 3000K
- 935 = 3500K
- 940 = 4000K
- TW = Tunable White 2200K - 4000K⁵
- WD = Warm Dim 1800K-3000K
- RGBW = 3000K White

Driver (Remote)⁶

- E1 = eldoLED 0.1% dimming, 0-10V (120-277V)
- L1 = Lutron 1% dimming, EcoSystem (120-277V)
- POE = Power over Ethernet
- BT = Wireless CAS - Casambi (Must specify BT with E1 or DALI)
- DALI = eldoLED DALI DT8 0.1% (120-277V)
- TQ = T-series for Lutron Quantum 0.1% (120-277V) [TW only]
- D010 = Osram, 10%, 0-10V dimming, 120-277V [WD only]
- DPH = Phase Dimming, 1% dimming, 120V only [WD only]
- L3DAE = Lutron Hi-lume 1% EcoSystem, 120-277V [WD only]
- L3D0E = Lutron Hi-lume Premier 0.1% EcoSystem, 120-277V (remote) [WD only]
- DMX = Osram + eldoLED 24V, DMX dimming [WD + RGBW Only]

Lens

- SD = Satin clear diffuser (standard)
- OD = Satin Opal diffuser

Finish⁷

- W = White, 15% gloss, RAL 9010 / Tiger Drylac 009/10120 (standard)
- F = Custom finish, specify RAL

Options

- CDC = Clear dust cover
- EM = Emergency LED driver (remote)

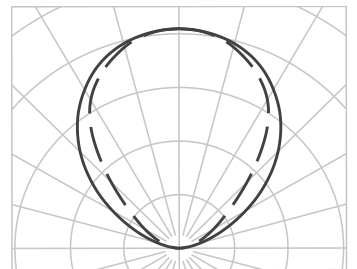

Polar Plot

Whitegoods reserves the right to change any information without prior notice.

Notes

- Standard setup assumes the cove ends at a perpendicular wall and the LED board is setback from the end to minimize light on the perpendicular wall. Contact us for options.
- See pattern specsheet.
- Wattage shown does not include power supplies/drivers.
- Refer to specsheet for delivered lumen data for all product configurations.
- TW offered up to P3 (10W/ft) power level.
- See power supply page for details.
- See Tiger Drylac color chart: inter-lux.com/tiger.

index

technical
information

Edgeless P Nose Cove

Cove system featuring plaster-in precision knife edge for clean, minimal effect. Non-illuminated.

- Complete system for wall-to-wall installations.
- Lengths and angles factory or field cut to exact field dimensions.
- Architectural element for plaster-in and field painting.
- Mitered and welded corners available.
- Made in the USA.

Housing	Precision extruded aluminum for true dimensions and tolerances Alignment hardware for invisible seam from below Housing provided in any exact length, or field cut Standard and tailored lengths Corners: standard and non-standard Finishes: Unpainted raw aluminum
Integration	Fixation into gypsum, hard ceilings and all grid ceiling types
Weight	2lbs per foot
Warranty	5-year Limited (see complete company warranty information)

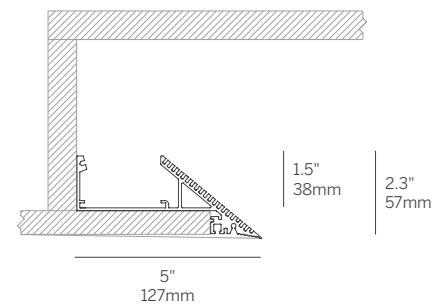

Gypsum Ceiling Mounting

Edgeless P Nose Cove

Model	Fixation	Pattern	Length	Finish
WG-EPN	RPT	S PC ¹ PR ¹ PPI ¹ PPO ¹ PZ ¹	A A x B A x B x C A x B x A x B	R

Model

- WG-EPN = Edgeless P Nose Cove

Fixation

- RPT = Recessed plaster trim

Pattern

- S = Straight run
- PC = Standard patterns coffer 2, 3 or 4 sided with 90° corners¹
- PR = Standard patterns raft 2, 3 or 4 sided with 90° corners¹
- PPI = Wall to wall / wall to ceiling, 90° inside corner¹
- PPO = Wall to wall / wall to ceiling, 90° outside corner¹
- PZ = Non-standard patterns and/or corners other than 90°, consult factory¹

Length

- A, B, C = specify inches to the nearest 0.25" (i.e. 72.25") For patterns specify each length (i.e. 2 sided: A x B = 72.25" x 48"; 3 sided: A x B x C; 4 sided: A x B x A x B)

Finish

- R = Unpainted Raw Aluminum

Whitegoods reserves the right to change any information without prior notice.

Notes

- 1 See pattern specsheet.

Edgeless Nose Cove

Cove system featuring plaster-in precision knife edge for clean, minimal effect. Non-illuminated.

- Complete system for wall-to-wall installations.
- Lengths and angles factory cut to exact field dimensions.
- Architectural element for plaster-in.
- Mitered and welded corners available with continuous illumination.
- Made in the USA.

Housing	Precision extruded aluminum for true dimensions and tolerances Alignment hardware for invisible seam from below Housing provided in any exact length, or field cut Standard and tailored lengths Corners: standard and non-standard Finishes: RAL 9010 white 15% gloss
Integration	Fixation into gypsum, hard ceilings and all grid ceiling types
Weight	2lbs per foot
Warranty	5-year Limited (see complete company warranty information)

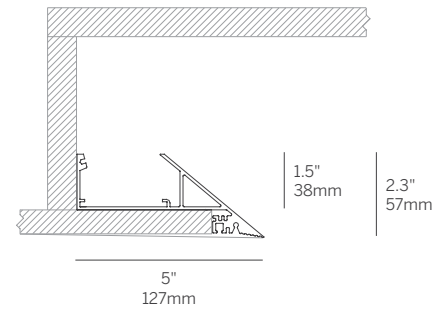
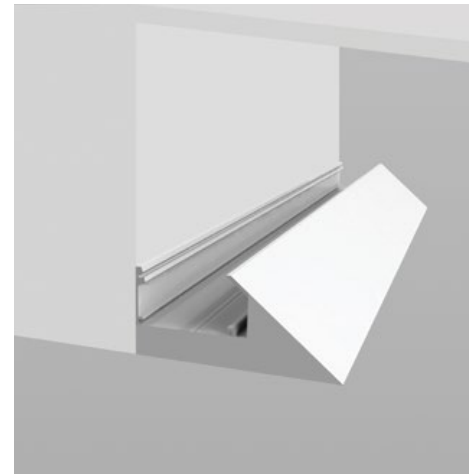

Gypsum Ceiling Mounting

Edgeless Nose Cove

Model	Fixation	Pattern	Length	Finish ²
WG-EN	RPT	S PC ¹ PR ¹ PPI ¹ PPO ¹ PZ ¹	A A x B A x B x C A x B x A x B	W (std) F

Model

- WG-EN = Edgeless Nose Cove

Fixation

- RPT = Recessed plaster trim

Pattern

- S = Straight run
- PC = Standard patterns coffer 2, 3 or 4 sided with 90° corners¹
- PR = Standard patterns raft 2, 3 or 4 sided with 90° corners¹
- PPI = Wall to wall / wall to ceiling, 90° inside corner¹
- PPO = Wall to wall / wall to ceiling, 90° outside corner¹
- PZ = Non-standard patterns and/or corners other than 90°, consult factory¹

Length

- A, B, C = specify inches to the nearest 0.25" (i.e. 72.25") For patterns specify each length (i.e. 2 sided: A x B = 72.25" x 48"; 3 sided: A x B x C; 4 sided: A x B x A x B)

Finish²

- W = White, 15% gloss, RAL 9010 / Tiger Drylac 009/10120 (standard)
- F = Custom finish, specify RAL

Whitegoods reserves the right to change any information without prior notice.

Notes

- 1 See pattern specsheet.
- 2 See Tiger Drylac color chart: inter-lux.com/tiger.



Perimeter

Perimeter lighting systems by Whitegoods are fully integrateable with any wall and ceiling surface, and designed to outline or accent a vertical plane to extend the volume of the space and draw interest. A perimeter lighting system can illuminate well into an adjacent space by using the wall as a secondary reflector, bouncing light across a hallway or into a lobby. A wall grazing system projects a sheet of light down the wall, with minimal room-side spill. Both systems allow the finished wall to continue above the ceiling plane so that the entire wall is illuminated with minimal visual impact by the luminaire.







V Cove

Continuous linear perimeter lighting system

- Light source positioned for optimum vertical spread of illumination.
- Light source is not visible from any viewing angle up to and including direct vertical view.
- Delivers continuous soft wash of directed light to adjacent wall surface.
- Satin Diffuser for high efficiency and soft edge beam without striations.
- Finished wall is illuminated from above the ceiling plane.
- Removable light source sub assembly for ease of installation and maintenance.
- High efficiency linear LED in a range of outputs, including static white, tunable white, warm dim and RGBW.
- Integral drivers and through wiring.
- Lengths and angles factory cut to exact field dimensions.
- Mitered and welded corners available with continuous illumination.
- Made in the USA.



Housing Precision extruded aluminum for true dimensions and tolerances
 Alignment hardware for invisible seam from below
 Housing provided in any exact length
 Unitized gear tray with LEDs for easy final installation
 Standard and tailored lengths
 Wall mounting allows the finished wall to extend above the ceiling plane.
 Infill top panel (optional)
 Corners: standard and non-standard
 Finishes: RAL 9010 white 15% gloss

Integration Fixation into gypsum, hard ceilings and all grid ceiling types

Distribution Asymmetric forward throw with max. beam at 40 degrees from nadir
 Redirected light for soft, even illumination of the adjacent wall surface
 Satin clear diffuser for wide, diffuse and efficient light emission

LED >90 CRI, 3-Step MacAdam, 2700-4000K static white
 1.5W - 15W per foot, 180 nominal lumens per watt average, constant current
 Tuneable white 2200-4000K, 80 nominal lumens per watt average
 Warm Dim to emulate incandescent when dimming; 75 nominal lumens per watt average
 RGBW, 50 nominal lumens per watt
 L70 (TM21 Projected 85C) Static White / Tunable White = 72,000 hours,
 RGBW = 50,000 hours, WD = 36,000 hours

Lens SDC - satin clear dust cover for wipe down applications

Driver Integral driver
 Compatible with quality constant current (Static White / Tunable White) and constant voltage (WD / RGBW) drivers

Connectivity POE
 Wireless

Weight 3lbs per foot

Operating Temp Suitable for operation in maximum ambient temperature of 35C (95F)

Warranty 5-year Limited (see complete company warranty information)

Certifications ETL and ETL-C for dry and damp location, CE

Voltages 120-277VAC

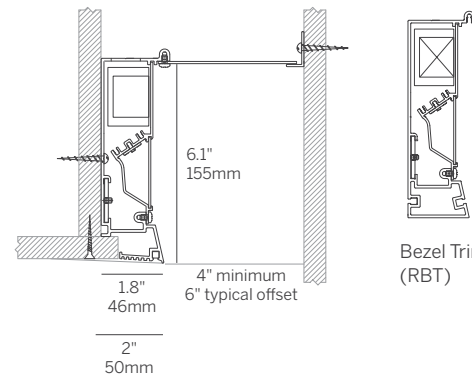

Gypsum Ceiling Mounting
 Plaster Trim (RPT)

V Cove

Model	Fixation	Pattern	Length	Power ³	CRI/ CCT ⁴	Driver ⁶	In-fill	Lens	Finish ⁷	Options
WG-VBC	RPT RBT	S ¹ P1 ² PO ² PZ ²	A A x B A x B x C A x B x A x B	P0	927 930 935 940 TW ⁵	E1 L1 POE BT DALI TQ	X P4 P6 PX	SDC (std)	W (std) F	EM
				L M H						

Model

- WG-VBC = V Cove

Fixation

- RPT = Recessed plaster trim
- RBT = Recessed bezel trim

Pattern

- S = Straight run¹
- PI = Standard patterns 2, 3, or 4 sided with 90° inside corners on the same plane²
- PO = Standard patterns 2, 3 or 4 sided with 90° outside corners on the same plane²
- PZ = Non-standard patterns and/or corners other than 90°; consult factory²

Length

- A, B, C = specify inches to the nearest 0.25" (i.e. 72.25") For patterns specify each length (i.e. 2 sided: A x B = 72.25" x 48"; 3 sided: A x B x C; 4 sided: A x B x A x B)

Power³

- P0 = 1.5 W/ft
- P1 = 3 W/ft
- P2 = 6 W/ft
- P3 = 10 W/ft
- P4 = 15 W/ft
- L = 2.7 W/ft WD low power (24V)
- M = 5.5 W/ft WD medium power (24V) [RGBW 7.6 W/ft]
- H = 8W/ft WD high power (24V)

CRI / CCT (90+ CRI minimum)⁴

- 927 = 2700K
- 930 = 3000K
- 935 = 3500K
- 940 = 4000K
- TW = Tunable White 2200K - 4000K⁵
- WD = Warm Dim 1800K-3000K
- RGBW = 3000K White

Driver (integral)⁶

- E1 = eldoLED 0.1% dimming, 0-10V (120-277V)
- L1 = Lutron 1% dimming, EcoSystem (120-277V)
- POE = Power over Ethernet
- BT = Wireless CAS - Casambi (Must specify BT with E1 or DALI)
- DALI = eldoLED DALI DT8 0.1% (120-277V)
- TQ = T-series for Lutron Quantum 0.1% (120-277V) [TW only]
- D010 = Osram, 10%, 0-10V dimming, 120-277V [WD only]
- L3DAE = Lutron Hi-lume 1% EcoSystem, 120-277V [WD only]
- L3DOE = Lutron Hi-lume Premier 0.1% EcoSystem, 120-277V (remote) [WD only]
- DMX = Osram + eldoLED 24V, DMX dimming [WD + RGBW Only]

In-fill

- X = No in-fill panel
- P4 = 4" in-fill panel
- P6 = 6" in-fill panel
- PX = Custom in-fill panel (contact factory)

Lens

- SDC = Satin clear diffuser (standard)

Finish⁷

- W = White, 15% gloss, RAL 9010 / Tiger Drylac 009/10120 (standard)
- F = Custom finish, specify RAL

Options

- EM = Emergency LED driver (remote)

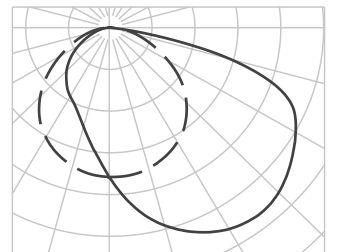

Polar Plot

Whitegoods reserves the right to change any information without prior notice.

Notes

- Standard setup assumes the cove ends at a perpendicular wall and the LED board is setback from the end to minimize light on the perpendicular wall. Contact us for options.
- See pattern specsheet.
- Wattage shown does not include power supplies/drivers.
- Refer to specsheet for delivered lumen data for all product configurations.
- TW offered up to P3 (10W/ft) power level.
- See power supply page for details.
- See Tiger Drylac color chart: inter-lux.com/tiger.

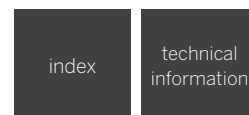

Z Cove

A knife edge perimeter slot system for continuous illumination of vertical surfaces available in any dimension to fully integrate with the architecture

- Linear perimeter slot system featuring plaster-in precision knife edge for clean, minimal effect.
- No visibility of light source when viewed from directly below knife edge.
- Delivers continuous soft wash of light to adjacent surface.
- Satin Diffuser for high efficiency and soft edge beam without striations.
- Finished wall is illuminated from above the ceiling plane.
- Removable light source sub assembly for ease of installation and maintenance.
- High efficiency linear LED in a range of outputs, including static white, tunable white, warm dim and RGBW.
- Integral drivers and through wiring.
- Lengths and angles factory cut to exact field dimensions.
- Mitered and welded corners available with continuous illumination.
- Made in the USA.

Housing Precision extruded aluminum for true dimensions and tolerances
Alignment hardware for invisible seam from below
Housing provided in any exact length
Unitized gear tray with LEDs for easy final installation
Standard and tailored lengths
Wall mounting allows the finished wall to extend above the ceiling plane.
Infill top panel (optional)
Corners: standard and non-standard
Finishes: RAL 9010 white 15% gloss

Integration Fixation into gypsum, hard ceilings and all grid ceiling types

Distribution Asymmetric forward throw with max. beam at 40 degrees from nadir
Redirected light for soft, even illumination of the top of the wall
Satin clear diffuser for wide, diffuse and efficient light emission

LED >90 CRI, 3-Step MacAdam, 2700-4000K static white
1.5W - 15W per foot, 180 nominal lumens per watt average, constant current
Tunable white 2200-4000K, 80 nominal lumens per watt average
Warm Dim to emulate incandescent when dimming; 75 nominal lumens per watt average
RGBW, 50 nominal lumens per watt
L70 (TM21 Projected 85C) Static White / Tunable White = 72,000 hours, RGBW = 50,000 hours, WD = 36,000 hours

Lens SDC - satin clear dust cover for wipe down applications

Driver Integral driver
Compatible with quality constant current (Static White / Tunable White) and constant voltage (WD / RGBW) drivers

Connectivity POE
Wireless

Weight 3lbs per foot

Operating Temp Suitable for operation in maximum ambient temperature of 35C (95F)

Warranty 5-year Limited (see complete company warranty information)

Certifications ETL and ETL-C for dry and damp location, CE

Voltages 120-277VAC

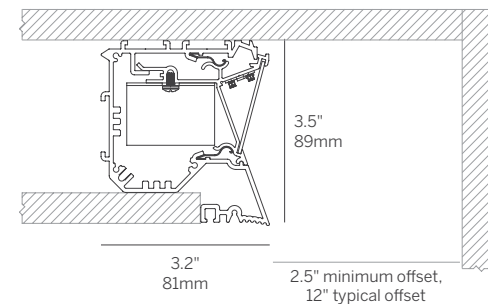

Gypsum Ceiling Mounting
Plaster Trim (RPT)

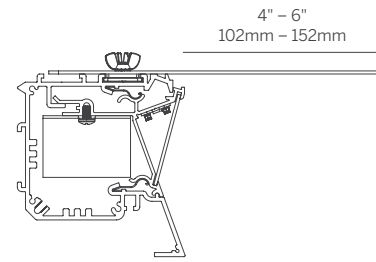

Bezel Trim (RBT)
Shown with optional in-fill panel

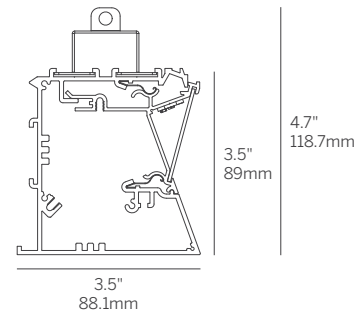

Grid Trim (RGT9, RGT15)

Z Cove

Model	Fixation	Pattern	Length	Power ³	CRI/CCT ⁴	Driver ⁶	In-fill	Lens	Finish ⁷	Options
WG-ZC	RPT RBT RGT9 RGT15	S ¹ PI ² PO ² PZ ²	A A x B A x B x C A x B x A x B	P0	927	E1	X P4 P5 PX	SDC (std)	W (std) F	EM
				P1	930	L1				
				P2	935	POE				
				P3	940	BT				
				P4	TW ⁵	DALI TQ				
				L M H	WD RGBW	D010 L3DAE L3DOE EL96 DMX				

Model

- WG-ZC = Z Cove Flat Diffuser

Fixation

- RPT = Recessed plaster trim
- RBT = Recessed bezel trim
- RGT9 = Recessed grid trim 9/16"
- RGT15 = Recessed grid trim 15/16"

Pattern

- S = Straight run¹
- PI = Standard patterns 2, 3, or 4 sided with 90° inside corners on the same plane²
- PO = Standard patterns 2, 3 or 4 sided with 90° outside corners on the same plane²
- PZ = Non-standard patterns and/or corners other than 90°, consult factory²

Length

- A, B, C = specify inches to the nearest 0.25" (i.e. 72.25") For patterns specify each length (i.e. 2 sided: A x B = 72.25" x 48"; 3 sided: A x B x C; 4 sided: A x B x A x B)

Power³

- P0 = 1.5 W/ft
- P1 = 3 W/ft
- P2 = 6 W/ft
- P3 = 10 W/ft
- P4 = 15 W/ft
- L = 2.7 W/ft WD low power (24V)
- M = 5.5 W/ft WD medium power (24V) [RGBW 7.6 W/ft]
- H = 8W/ft WD high power (24V)

CRI / CCT (90+ CRI minimum)⁴

- 927 = 2700K
- 930 = 3000K
- 935 = 3500K
- 940 = 4000K
- TW = Tunable White 2200K - 4000K⁵
- WD = Warm Dim 1800K-3000K
- RGBW = 3000K White

Driver (integral)⁶

- E1 = eldoLED 0.1% dimming, 0-10V (120-277V)
- L1 = Lutron 1% dimming, EcoSystem (120-277V)
- POE = Power over Ethernet
- BT = Wireless CAS - Casambi (Must specify BT with E1 or DALI)
- DALI = eldoLED DALI DT8 0.1% (120-277V)
- TQ = T-series for Lutron Quantum 0.1% (120-277V) [TW only]
- D010 = Osram, 10%, 0-10V dimming, 120-277V [WD only]
- L3DAE = Lutron Hi-lume 1% EcoSystem, 120-277V [WD only]
- L3DOE = Lutron Hi-lume Premier 0.1% EcoSystem, 120-277V (remote) [WD only]
- DMX = Osram + eldoLED 24V, DMX dimming [WD + RGBW Only]

In-fill

- X = No in-fill panel
- P4 = 4" - 5" adjustable in-fill panel
- P5 = 5" - 6" adjustable in-fill panel
- PX = Custom in-fill panel (contact factory)

Lens

- SDC = Satin clear diffuser (standard)

Finish⁷

- W = White, 15% gloss, RAL 9010 / Tiger Drylac 009/10120 (standard)
- F = Custom finish, specify RAL

Options

- EM = Emergency LED driver (remote)

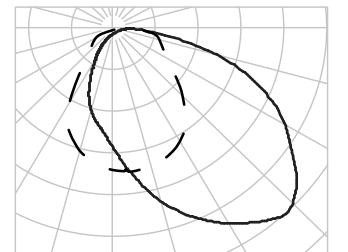

Polar Plot

Whitegoods reserves the right to change any information without prior notice.

Notes

- Standard setup assumes the cove ends at a perpendicular wall and the LED board is setback from the end to minimize light on the perpendicular wall. Contact us for options.
- See pattern specsheet.
- Wattage shown does not include power supplies/drivers.
- Refer to specsheet for delivered lumen data for all product configurations.
- TW offered up to P3 (10W/ft) power level.
- See power supply page for details.
- See Tiger Drylac color chart: inter-lux.com/tiger.

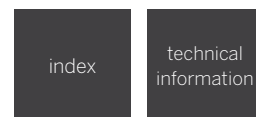

20 Linear Mini Z Cove

Compact and powerful continuous perimeter luminaire with plaster-in Plaster Trim knife edge detail for a perfect finish. Delivers light smoothly down the wall from a concealed position.

- Miniature continuous perimeter light with knife edge detail.
- Flush snap-in Opal Diffuser (standard) for evenly illuminated lens.
- Flush snap-in Satin Diffuser or Micro-prismatic lens for maximum efficiency.
- Trimless installation into drywall without disturbing the ceiling structure.
- Snap-in LED fixture for easy installation and maintenance
- Continuous mounting to any desired length.
- Removable light source sub assembly for ease of installation and maintenance.
- High efficiency linear LED in a range of outputs, including static white, tunable white, warm dim and RGBW.
- Remote driver, low voltage wiring.
- Lengths and angles factory cut to exact field dimensions.
- Mitered and welded corners available with continuous illumination.
- Made in the USA.

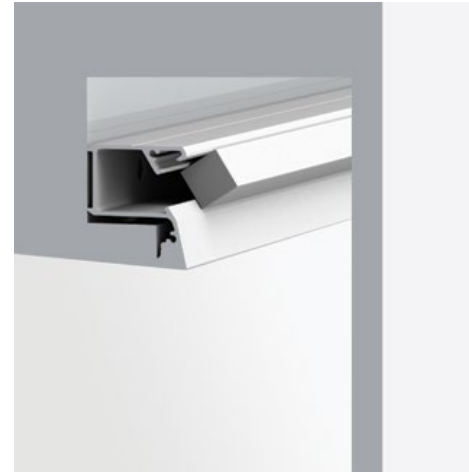

Housing Precision extruded aluminum for true dimensions and tolerances
Alignment hardware for invisible seam from below
Housing provided in any exact length
Snap-in LED insert for easy final installation
Standard and tailored lengths
Corners: standard and non-standard
Finishes: RAL 9010 white 15% gloss

Integration Seamless, architectural integration into gypsum walls and ceilings

Distribution Continuous even illumination using an opal lens for homogeneous lens appearance, or satin diffuser / micro-prismatic lens for higher efficiency

LED >90 CRI, 3-Step MacAdam, 2700-4000K static white
1.5W - 10W per foot, 180 nominal lumens per watt average, constant current
Tunable white 2200-4000K, 80 nominal lumens per watt average
Warm Dim to emulate incandescent when dimming; 75 nominal lumens per watt average
RGBW, 50 nominal lumens per watt
L70 (TM21 Projected 85C) Static White / Tunable White = 72,000 hours, RGBW = 50,000 hours, WD = 36,000 hours

Lens OD - Opal Diffuser provides even, continuous line of light and general illumination
SD - Satin Clear Diffuser provides high efficiency soft edge beam, general illumination
MPL - Micro-prismatic lens provides lower brightness, general illumination

Driver Remote driver
Compatible with quality constant current (Static White / Tunable White) and constant voltage (WD / RGBW) drivers

Connectivity POE
Wireless

Weight 3lbs per foot

Operating Temp Suitable for operation in maximum ambient temperature of 35C (95F)

Warranty 5-year Limited (see complete company warranty information)

Certifications ETL and ETL-C for dry and damp location, CE

Voltages Low Voltage Fixture / 120-277VAC Driver (remote)

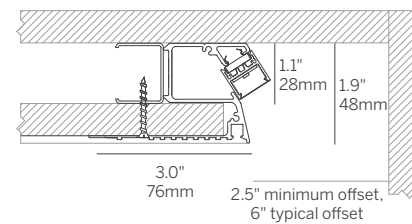

Gypsum Ceiling Mounting Options

20 Linear Mini Z Cove

Model	Fixation	Pattern	Length	Power ²	CRI/ CCT ³	Driver ⁵	Lens	Finish ⁶	Options
WG-MZC	RPT	S PI ¹ PO ¹ PZ ¹	A A x B A x B x C A x B x A x B	P0 P1 P2 P3	927 930 935 940 TW ⁴	E1 L1 POE BT DALI TQ	OD (std) SD MPL	W (std) F	EM
				L M H	WD RGBW	D010 DPH L3DAE L3DOE EL96 DMX			

Model

- WG-20MZC = 20 Linear Mini Z Cove

Fixation

- RPT = Recessed plaster trim

Pattern

- S = Straight run
- PI = Standard patterns 2, 3, or 4 sided with 90° inside corners on the same plane¹
- PO = Standard patterns 2, 3 or 4 sided with 90° outside corners on the same plane¹
- PZ = Non-standard patterns and/or corners other than 90°; consult factory¹

Length

- A, B, C = specify inches to the nearest 0.25" (i.e. 72.25")
For patterns specify each length (i.e. 2 sided: A x B = 72.25" x 48"; 3 sided: A x B x C; 4 sided: A x B x A x B)

Power²

- P0 = 1.5 W/ft
- P1 = 3 W/ft
- P2 = 6 W/ft
- P3 = 10 W/ft
- L = 2.7 W/ft WD low power (24V)
- M = 5.5 W/ft WD medium power (24V) [RGBW 7.6 W/ft]
- H = 8W/ft WD high power (24V)

CRI / CCT (90+ CRI minimum)³

- 927 = 2700K
- 930 = 3000K
- 935 = 3500K
- 940 = 4000K
- TW = Tunable White 2200K - 4000K⁴
- WD = Warm Dim 1800K-3000K
- RGBW = 3000K White

Driver (remote)⁵

- E1 = eldoLED 0.1% dimming, 0-10V (120-277V)
- L1 = Lutron 1% dimming, EcoSystem (120-277V)
- POE = Power over Ethernet
- BT = Wireless CAS - Casambi (Must specify BT with E1 or DALI)
- DALI = eldoLED DALI DT8 0.1% (120-277V)
- TQ = T-series for Lutron Quantum 0.1 % (120-277V) [TW only]
- D010 = Osram, 10%, 0-10V dimming, 120-277V [WD only]
- DPH = Phase Dimming, 1% dimming, 120V only [WD only]
- L3DAE = Lutron Hi-lume 1% EcoSystem, 120-277V [WD only]
- L3DOE = Lutron Hi-lume Premier 0.1% EcoSystem, 120-277V (remote) [WD only]
- DMX = Osram + eldoLED 24V, DMX dimming [WD + RGBW Only]

Lens

- OD = Satin opal diffuser (standard)
- SD = Satin clear diffuser
- MPL = Micro-prismatic lens

Finish⁶

- W = White, 15% gloss, RAL 9010 / Tiger Drylac 009/10120 (standard)
- F = Custom finish, specify RAL

Finish

- EM = Emergency LED driver (remote)

Polar Plots

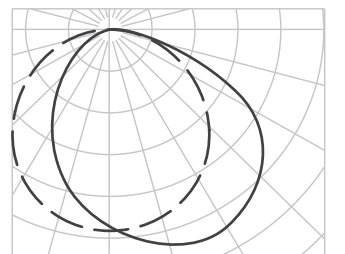

OD-W

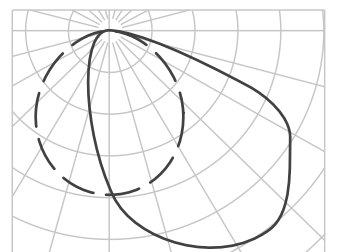

SD-W

Whitegoods reserves the right to change any information without prior notice.

Notes

- 1 See pattern specsheet.
- 2 Wattage shown does not include power supplies/drivers.
- 3 Refer to specsheet for delivered lumen data for all product configurations.
- 4 TW offered up to P3 (10W/ft) power level.
- 5 See power supply page for details.
- 6 See Tiger Drylac color chart: inter-lux.com/tiger.

index

technical
information

20 Linear Perimeter Flush

A perimeter pocket system with flush mounted light source for continuous illumination of adjacent surfaces, available in any dimension to fully integrate with the architecture

- Perimeter lighting system with regressed light source for general illumination and feature wall grazing.
- Recessed Luminaire allows the finished wall to continue above the ceiling plane for full wall illumination.
- *Soft-graze* option to control textured wall contrast and accommodate feature wall thickness.
- Trimless and bezel trim for seamless integration into any drywall, wood and metal surfaces.
- Straight runs and configurations with factory corners in exact lengths as specified.
- Removable light source sub assembly for ease of installation and maintenance.
- High efficiency linear LED in a range of outputs, including static white, tunable white, warm dim and RGBW.
- Remote driver, low voltage wiring.
- Lengths and angles factory cut to exact field dimensions.
- Mitered and welded corners available with continuous illumination.
- Made in the USA.

Housing Precision extruded aluminum for true dimensions and tolerances
Integration into any ceiling type
All low voltage connections made in the housing
Luminaires snaps into the housing without tools
Finishes: white, black, silver and custom

Integration Fixation into gypsum, hard ceilings and all grid ceiling types

Distribution General, continuous

LED Constant Voltage, 90+ CRI, 3 Steps MacAdam
120 nominal lumens/watt average (see spec sheet for delivered lumens)
Conformal coated for protection against humidity optional (-WL)
Warm Dim to emulate incandescent when dimming; 75 nominal lumens per watt average
RGBW for color changing applications; 50 nominal lumens per watt average
L70 (TM21 Projected 85C) Static White = 60,000 hours
RGBW = 50,000 hours, WD = 36,000 hours

Lens OD - Opal Diffuser provides even, continuous line of light and general illumination
MPL - Micro-prismatic lens provides lower brightness, general illumination

Driver Compatible with quality constant voltage drivers

Weight 2lbs per foot (20LPF); 3lbs per foot (20LPFSG)

Operating Temp Suitable for operation in maximum ambient temperature of 35C (95F)

Warranty 5-year Limited (see complete company warranty information)

Certifications ETL and ETL-C for dry and damp location, CE

Voltages 24V Fixture / 120-277VAC Driver (remote)

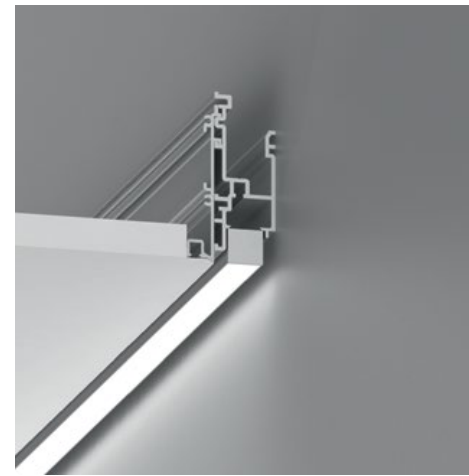
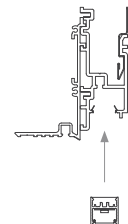

Recessed Plaster Trim (RPT)

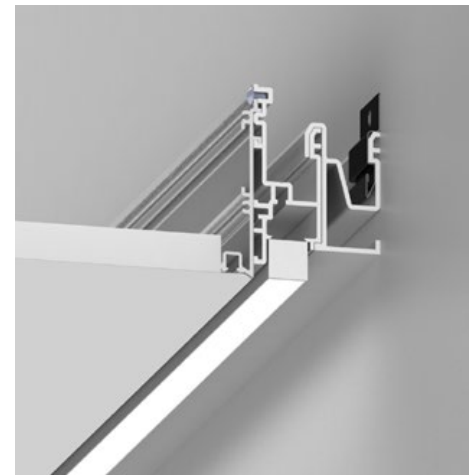

Soft Graze (SG) Recessed Plaster Trim (RPT)

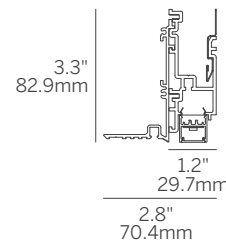

Recessed Plaster Trim (RPT)

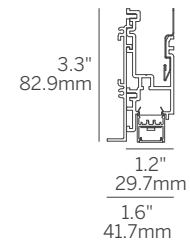

Recessed Bezel Trim (RBT)
Recessed Grid Trim (RGT9/RGT15)

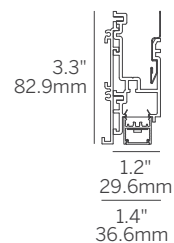

Recessed Return Trim (RRT)

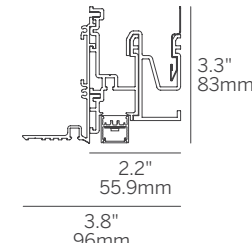

Soft Graze (SG)
Recessed Plaster Trim (RPT)

20 Linear Perimeter Flush

Model	Fixation	Pattern	Length	Power ²	CRI/ CCT ³	Driver ¹	Lens	Finish ⁵	Options
WG-20LPF	RPT	S	A	L	927	X	OD (std)	W (std)	EM
WG-20LPFSG	RBT	PI ¹	A x B	M	930	S	MPL	B	WL ⁶
	RRT	PO ¹	A x B x C	H	935	D010		S	
	RGT9		A x B x A		940	DPH		F	
	RGT15		x B		WD	L3DAE			
					RGBW	L3DOE			
						EL96			
						DMX			

Model

- WG-20LPF = 20 Linear Perimeter Flush
- WG-20LPFSG = 20 Linear Perimeter Flush *Soft Graze*

Fixation

- RPT = Recessed plaster trim
- RBT = Recessed bezel trim
- RRT = Recessed return trim
- RGT9 = Recessed grid trim 9/16"
- RGT15 = Recessed grid trim 15/16"

Pattern

- S = Straight run
- PI = Standard patterns 2, 3 or 4 sided with 90° inside corners on the same plane¹
- PO = Standard patterns 2, 3 or 4 sided with 90° outside corners on the same plane¹

Length

- A, B, C = specify inches to the nearest 0.25" (i.e. 72.25")
For patterns specify each length (i.e. 2 sided: A x B = 72.25" x 48"; 3 sided: A x B x C; 4 sided: A x B x A x B)
- For 2 and 4 foot fixtures to fit ceiling grids specify 24" and 48" lengths

Power²

- L = 3W/ft low power (WD 2.7 W/ft) (24V)
- M = 6W/ft mid power (WD 5.5 W/ft) (24V) (RGBW - 7.6 W/ft)
- H = 10W/ft high power (WD 8 W/ft) (24V)

CRI / CCT (90+ CRI minimum)³

- 927 = 2700K
- 930 = 3000K
- 935 = 3500K
- 940 = 4000K
- WD = Warm Dimming 1800 - 3000K
- RGBW = 3000K White (M power only)

Whitegoods reserves the right to change any information without prior notice.

Notes

- 1 See pattern specsheet.
- 2 Wattage shown does not include power supplies/drivers.
- 3 Refer to specsheet for delivered lumen data for all product configurations.
- 4 TW offered up to P3 (10W/ft) power level.

Driver (remote)⁴

- X = No driver, ordered separately
- S = Standard, non-dim driver 120-277V
- D010 = Osram, 10%, 0-10V dimming, 120-277V
- DPH = Phase Dimming, 1% dimming, 120V only
- L3DAE = Lutron Hi-lume 1% EcoSystem, 120-277V
- L3DOE = Lutron Hi-lume Premier 0.1% EcoSystem, 120-277V
- EL96 = Osram / EldoLED, 24V, 0.1% 0-10V Dimming
- DMX = Osram / EldoLED, 24V, 0.1% DMX Dimming

Lens

- OD = Satin opal diffuser (standard)
- MPL = Micro-prismatic lens

Finish⁵

- W = White, 15% gloss, RAL 9010 / Tiger Drylac 009/10120 (standard)
- B = Black, 15% gloss, RAL 9005 / Tiger Drylac 049/90053
- S = Silver, 15% gloss, RAL 9006 / Tiger Drylac 049/90500

Options

- EM = Emergency (remote)
- WL = Wet Location Under Canopy / Cover⁶

Polar Plots

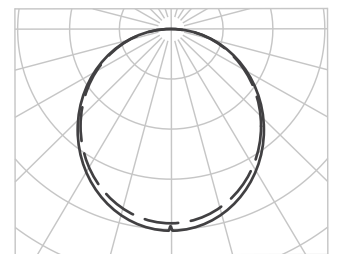

OD-W

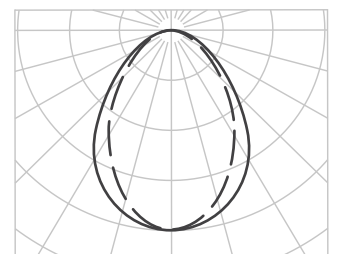

MPL-W

20 Linear Perimeter Regressed and Wallgraze

A perimeter pocket system with regressed light source for continuous illumination of adjacent surfaces, available in any dimension to fully integrate with the architecture

- Perimeter lighting system with regressed light source for general illumination and feature wall grazing.
- Recessed Luminaire allows the finished wall to continue above the ceiling plane for full wall illumination.
- *Soft-graze* option to control textured wall contrast and accommodate feature wall thickness.
- Trimless and bezel trim for seamless integration into any drywall, wood and metal surfaces.
- Straight runs and configurations with factory corners in exact lengths as specified.
- Removable light source sub assembly for ease of installation and maintenance.
- High efficiency linear LED in a range of outputs, including static white, tunable white, warm dim and RGBW.
- Remote driver, low voltage wiring.
- Lengths and angles factory cut to exact field dimensions.
- Mitered and welded corners available with continuous illumination.
- Made in the USA.

Housing Precision extruded aluminum for true dimensions and tolerances
Integration into any ceiling type
All low voltage connections made in the housing
Luminaires snaps into the housing without tools
Finishes: white, black, silver and custom

Integration Fixation into gypsum, hard ceilings and all grid ceiling types

Distribution Lenses and louvers for general and grazing applications

LED >90 CRI, 3-Step MacAdam, 2700-4000K static white
1.5W - 10W per foot, 180 nominal lumens per watt average, constant current
Tunable white 2200-4000K, 80 nominal lumens per watt average
Warm Dim to emulate incandescent when dimming; 75 nominal lumens per watt average
RGBW, 50 nominal lumens per watt
L70 (TM21 Projected 85C) Static White / Tunable White = 72,000 hours, RGBW = 50,000 hours, WD = 36,000 hours

Lens OD - Opal Diffuser provides even, continuous line of light and general illumination
SD - Satin Clear Diffuser provides high efficiency soft edge beam, general illumination
MPL - Micro-prismatic lens provides lower brightness, general illumination
NL16 - Narrow Lens optic provides narrow beam for wall grazing applications
LL45 - 45 Degree Louver in white, black or satin provides extreme low brightness

Driver Remote driver
Compatible with quality constant current (Static White / Tunable White) and constant voltage (WD / RGBW) drivers

Connectivity POE
Wireless

Weight 2lbs per foot (20LPR); 3lbs per foot (20LPRSG)

Operating Temp Suitable for operation in maximum ambient temperature of 35C (95F)

Warranty 5-year Limited (see complete company warranty information)

Certifications ETL and ETL-C for dry and damp location, CE

Voltages Low Voltage Fixture / 120-277VAC Driver (remote)

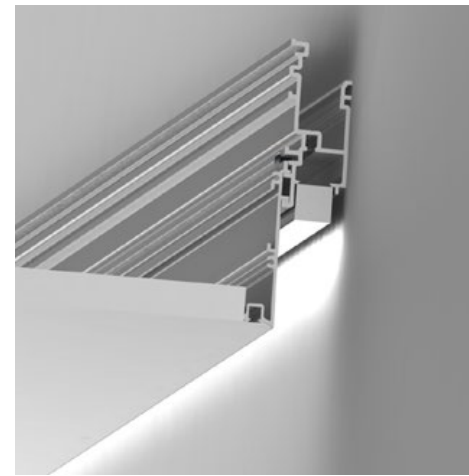
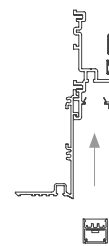

Recessed Plaster Trim (RPT)

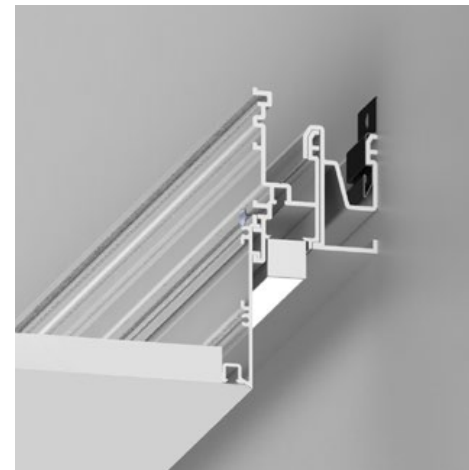

Soft Graze (SG) Recessed Plaster Trim (RPT)

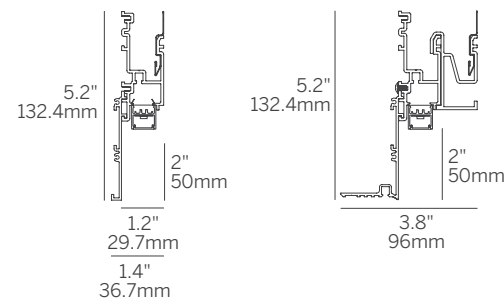
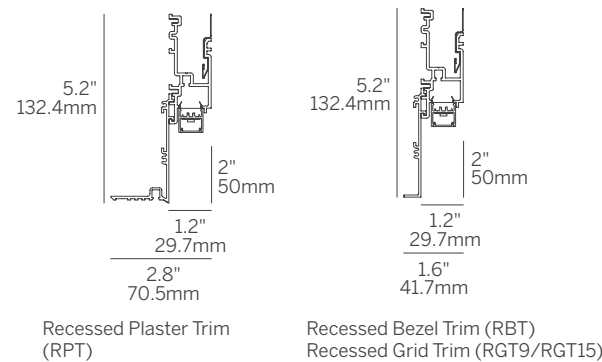

Recessed Return Trim (RRT) Soft Graze (SG) Recessed Plaster Trim (RPT)

20 Linear Perimeter Regressed and Wallgraze

Model	Fixation	Pattern	Length	Power ²	CRI/CCT ³	Driver ⁵	Lens	Finish ⁷	Options
WG-20LPR WG-20LPRSG	RPT RBT RRT RGT9 RGT15	S PI ¹ PO ¹ PZ ¹	A A x B A x B x C A x B x A x B	P0 P1 P2 P3	927 930 935 940 TW ⁴	E1 L1 POE BT DALI TQ	OD (std) SD MPL NL16 LL45B ⁶ LL45W ⁶ LL45S ⁶	W (std) B S F	EM WL ⁸
				L M H	WD RGBW	D010 DPH L3DAE L3DOE EL96 DMX			

Model

- WG-20LPR = 20 Linear Perimeter Regressed
- WG-20LPRSG = 20 Linear Perimeter Regressed Soft Graze

Fixation

- RPT = Recessed plastertrim
- RBT = Recessed bezel trim
- RRT = Recessed return trim
- RGT9 = Recessed grid trim 9/16"
- RGT15 = Recessed grid trim 15/16"

Pattern

- S = Straight run
- PI = Standard patterns 2, 3, or 4 sided with 90° inside corners on the same plane¹
- PO = Standard patterns 2, 3 or 4 sided with 90° outside corners on the same plane¹
- PZ = Non-standard patterns and/or corners other than 90°; consult factory¹

Length

- A, B, C = specify inches to the nearest 0.25" (i.e. 72.25")
For patterns specify each length (i.e. 2 sided: A x B = 72.25" x 48"; 3 sided: A x B x C; 4 sided: A x B x A x B)
- For 2 and 4 foot fixtures to fit ceiling grids specify 24" and 48" lengths

Power²

- P0 = 1.5 W/ft
- P1 = 3 W/ft
- P2 = 6 W/ft
- P3 = 10 W/ft
- L = 2.7 W/ft WD low power (24V)
- M = 5.5 W/ft WD medium power (24V) [RGBW 7.6 W/ft]
- H = 8W/ft WD high power (24V)

CRI / CCT (90+ CRI minimum)³

- 927 = 2700K
- 930 = 3000K
- 935 = 3500K
- 940 = 4000K
- TW = Tunable White 2200K - 4000K⁴
- WD = Warm Dim 1800K-3000K
- RGBW = 3000K White

Whitegoods reserves the right to change any information without prior notice.

Notes

- 1 See pattern specsheet.
- 2 Wattage shown does not include power supplies/drivers.
- 3 Refer to specsheet for delivered lumen data for all product configurations.
- 4 TW offered up to P3 (10W/ft) power level.

Driver (remote)⁵

- E1 = eldoLED 0.1% dimming, 0-10V (120-277V)
- L1 = Lutron 1% dimming, EcoSystem (120-277V)
- POE = Power over Ethernet
- BT = Wireless CAS - Casambi (Must specify BT with E1 or DALI)
- DALI = eldoLED DALI DT8 0.1% (120-277V)
- TQ = T-series for Lutron Quantum 0.1% (120-277V) [TW only]
- D010 = Osram, 10%, 0-10V dimming, 120-277V [WD only]
- DPH = Phase Dimming, 1% dimming, 120V only [WD only]
- L3DAE = Lutron Hi-lume 1% EcoSystem, 120-277V [WD only]
- L3DOE = Lutron Hi-lume Premier 0.1% EcoSystem, 120-277V (remote) [WD only]
- DMX = Osram + eldoLED 24V, DMX dimming [WD + RGBW Only]

Lens

- OD = Satin opal diffuser (standard)
- SD = Satin clear diffuser
- MPL = Micro-prismatic lens
- NL16 = Linear narrow lens, 16°
- LL45B = Linear louver black⁶
- LL45W = Linear louver white⁶
- LL45S = Linear louver satin⁶

Finish⁷

- W = White, 15% gloss, RAL 9010 / Tiger Drylac 009/10120 (standard)
- B = Black, 15% gloss, RAL 9005 / Tiger Drylac 049/90053
- S = Silver, 15% gloss, RAL 9006 / Tiger Drylac 049/90500
- F = Custom finished trim, specify RAL

Options

- EM = Emergency LED driver (remote)
- WL = Wet Location Under Canopy / Cover⁸

Polar Plots

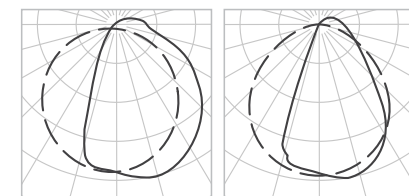

OD-W SD-W

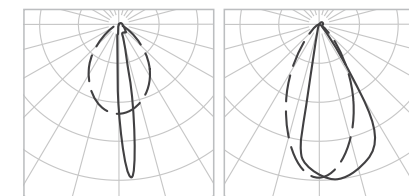

NL16-W LL45B-W

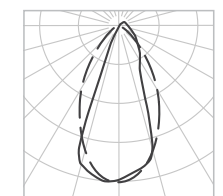

LL45W-W

ProTools 60 Linear Perimeter Recessed

A continuous linear system that delivers even illumination to a wall from above the finished ceiling to illuminate a space and define vertical surfaces

- 2.4" aperture, integrated solution that is compatible with all ceiling types
- Standard and tailored run lengths, including corners
- Evenly illuminated perimeter lighting system
- Soft Graze option to vary light center from the wall
- Recessed optics minimizes brightness
- Consistent LED technology throughout the Whitegoods product range
- Easy to install housing allows the wall to continue above the finished ceiling
- Flexible design allows exact wall-to-wall dimensions
- Flicker-free full range dimming with standard driver (Eldoled)
- Manufactured in the USA

- Housing** Precision extruded aluminum for true dimensions and tolerances
Toolless component assembly from below
Perfect fit with inserts, louvers and lenses
Standard and tailored lengths including corner configurations
Soft Graze adds 1" - 3" additional set-off for less dramatic graze
Recessed snap-in cover for non-illuminated section
Finishes: white, black, silver and custom
- Integration** Fixation into gypsum, hard ceilings and all grid ceiling types
Finished wall continues past the ceiling line
- Distribution** Evenly illuminated regressed, recessed lens or Soft Graze
- LED** >90 CRI, 3-Step MacAdam, 2700-4000K static white
3W - 15W per foot, 180 nominal lumens per watt average
RA 91-94 (2700-4000K)
L70 (TM21 Projected 85C) Static White / Tunable White = 72,000 hours
Tuneable white 2200-4000K, 80 nominal lumens per watt average
- Optic** RML - recessed micro-prismatic lens | diffusion with maximum efficiency
RLW/RLB - recessed louver white (W) or black (B) | extreme cutoff
REO - Recessed elliptical optic - high efficiency graze
- Reflector** White: high efficiency (standard with RLW)
Black: no brightness (standard with RLB)
Silver: low brightness
All 15% gloss
Custom finish available
- Driver** Compatible with quality constant current drivers
- Connectivity** POE
Wireless
- Weight** 4lbs per foot
- Operating Temp** Suitable for operation in maximum ambient temperature of 35C (95F)
- Warranty** 5-year Limited (see complete company warranty information)
- Certifications** ETL and ETL-C for dry and damp location, CE, Chicago plenum
- Voltages** 120-277VAC

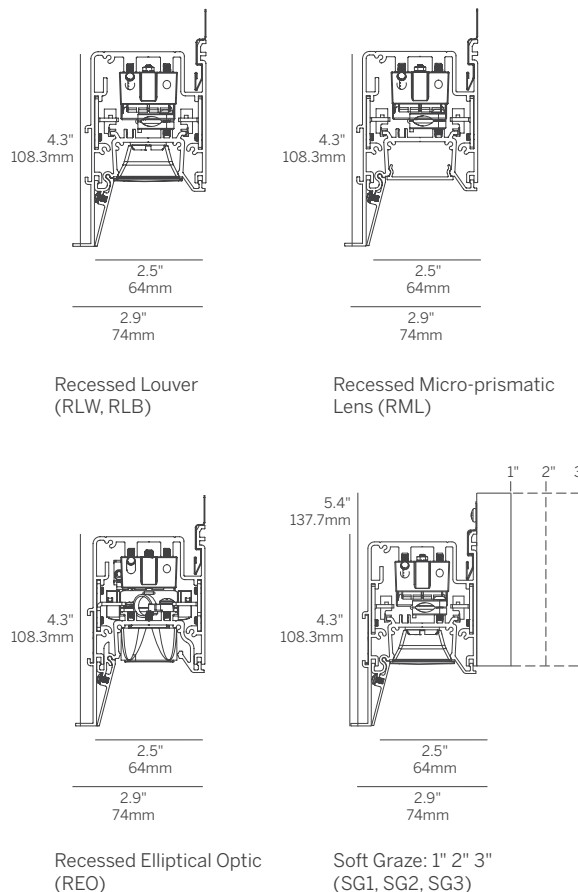
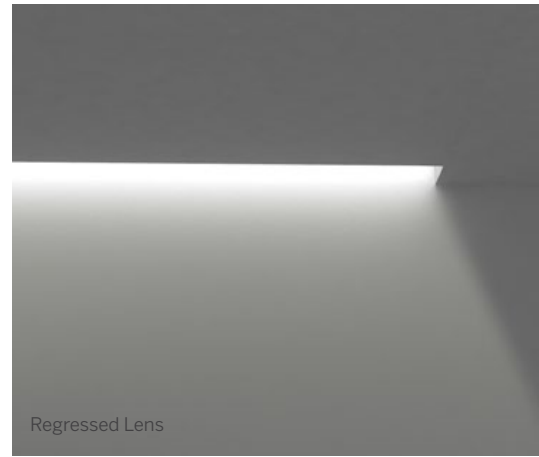

ProTools 60 Linear Perimeter Recessed

Model	Fixation	Pattern	Length ²	CRI/CCT	Optic ³	Beam	Power ⁵	Driver ⁶	Housing Finish ⁷	Reflector Finish ⁷	Options
WG-60PTLP	RPT	S	24	927	RML	80	P1	E1	W	W	CP
WG-60PTLPSG1	RBT	PI ¹	48	930	RLW	35	P2	L1	B	B	EM
WG-60PTLPSG2	RGT9	PO ¹	96	935	RLB	50	P3	POE	S	S	NYC
WG-60PTLPSG3	RGT15		XX ³	940	REO	20x40	P4	BT	F	F	TF
				TW ⁴				DALI			
								TQ			

Model

- WG-60PTLP = ProTools 60 Linear Perimeter
- WG-60PTLPSG1 = ProTools 60 Linear Perimeter Soft Graze 1" extension
- WG-60PTLPSG2 = ProTools 60 Linear Perimeter Soft Graze 2" extension
- WG-60PTLPSG3 = ProTools 60 Linear Perimeter Soft Graze 3" extension

Fixation

- RPT = Recessed plaster trim
- RBT = Recessed trim for hard ceiling
- RGT9 = Recessed trim for 9/16" grid
- RGT15 = Recessed trim for 15/16" grid
- RGTS = Recessed trim for slot grid

Pattern

- S = Straight run
- PI = Standard patterns 2, 3 or 4 sided with 90° inside corners on the same plane¹
- PO = Standard patterns 2, 3 or 4 sided with 90° outside corners on the same plane¹

Length²

- 24 = 24"
- 48 = 48"
- 96 = 96"
- XX = Specify inches to the nearest 0.25"³

CRI / CCT (90+ CRI minimum)

- 927 = 2700K
- 930 = 3000K
- 935 = 3500K
- 940 = 4000K
- TW = Tuneable white 2200-4000K⁴

Optic³

- RML = Recessed micro-prismatic lens
- RLW = Recessed louver white (supplied with white reflectors standard)
- RLB = Recessed louver black (supplied with black reflectors standard)
- REO = Recessed elliptical optic

Notes

- See pattern spec sheet.
- Individual fixture lengths less than 2' may require remote driver.
- Specify Lensed products to nearest 0.25". Specify Louvered and Tuneable White products in 12" increments for continuous light. Louver supplied in 12" increments, balance of the run will have recessed blank covers on ends.

Beam

- 80 = 80° (RML)
- 35 = 35° (RLW, RLB)
- 50 = 50° (RLW, RLB)
- 20x40 = 20x40° (REO)

Power⁵

- P1 = 3W/ft
- P2 = 6W/ft
- P3 = 10W/ft
- P4 = 15W/ft

Driver⁶

- E1 = EldoLED 0.1% dimming, 0-10V (120-277V)
- L1 = Lutron 1% dimming, Ecosystem (120-277V)
- PoE = Power over Ethernet
- BT = Wireless CAS - Casambi (Must specify BT with E1 or DALI)
- DALI = EldoLED Dali DT8 0.1% (120-277V)
- TQ = T-Series for Lutron Quantum 0.1% (120-277V) (Tunable white ONLY)

Housing / Trim Finish⁷

- W = White, 15% gloss, RAL 9003 / Tiger Drylac 49/11350 (standard)
- B = Black, 15% gloss, RAL 9005 / Tiger Drylac 44/90053
- S = Silver, 15% gloss, RAL 9006 / Tiger Drylac 49/90500
- F = Custom finished trim, specify RAL

Reflector Finish⁷

- W = White, 15% gloss, RAL 9003 / Tiger Drylac 49/11350 (standard)
- B = Black, 15% gloss, RAL 9005 / Tiger Drylac 44/90053
- S = Silver, 15% gloss, RAL 9006 / Tiger Drylac 49/90500
- F = Custom finished trim, specify RAL

Options

- CP = Chicago Plenum Rated
- EM = Emergency (remote)
- NYC = 6' whip per run
- TF = Top feed

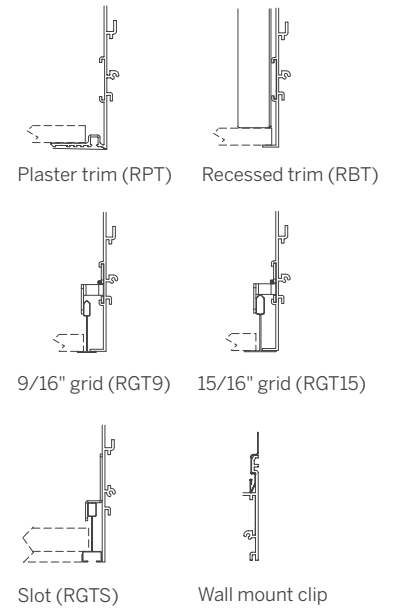

Polar Plots

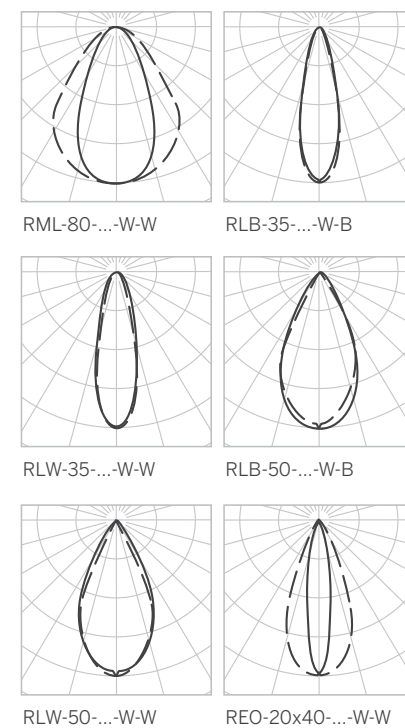

Whitegoods reserves the right to change any information without prior notice.

- TW only available with RML for P2 and P3.
- Refer to specsheet for delivered lumen data for all product configurations.
- See power supply page for details.
- See Tiger Drylac color chart: inter-lux.com/tiger

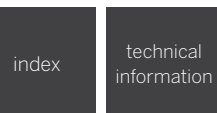

ProTools 60 Linear Wall Graze Recessed

An extremely low brightness perimeter lighting system that delivers a narrow sheet of light to a feature wall from above the finished ceiling – integrated with the architecture to otherwise minimize intrusion to the space.

- 2.4" aperture, integrated solution that is compatible with all ceiling types
 - Standard and tailored run lengths, including corners
 - Graze to 30' wall height
 - Soft Graze to vary light center from the wall
 - Extreme brightness control and the elimination of disturbing glare
 - Consistent LED technology throughout the
- Whitegoods product range
 - Easy to install housing allows the wall to continue above the finished ceiling
 - Flexible design allows exact wall-to-wall dimensions
 - Flicker-free full range dimming with standard driver (Eldoled)
 - Manufactured in the USA

Housing Precision extruded aluminum for true dimensions and tolerances
Toolless component assembly from below
Perfect fit with inserts, louvers and lenses
Standard and tailored lengths including corner configurations
Soft Graze adds 1" - 3" additional set-off for less dramatic graze
Recessed snap-in cover for non-illuminated section
Finishes: white, black, silver and custom

Integration Fixation into gypsum, hard ceilings and all grid ceiling types
Finished wall continues past the ceiling line

Distribution Wall Graze and Soft Graze

LED >90 CRI, 3-Step MacAdam; 2700K-4000K static white, constant current
3W - 15W per foot, 180 nominal lumens per watt average
RA 91-94 (2700-4000K)
L70 (TM21 Projected 85C) Static White = 72,000 hours

Optic RLW/RLB - recessed louver white (W) or black (B) | extreme cutoff
REO - Recessed elliptical optic - high efficiency graze

Reflector White: high efficiency (standard with RLW)
Black: no brightness (standard with RLB)
Silver: low brightness
All 15% gloss
Custom finish available

Driver Compatible with quality constant current drivers

Connectivity POE
Wireless

Weight 4lbs per foot

Operating Temp Suitable for operation in maximum ambient temperature of 35C (95F)

Warranty 5-year Limited (see complete company warranty information)

Certifications ETL and ETL-C for dry and damp location

Voltages 120-277VAC

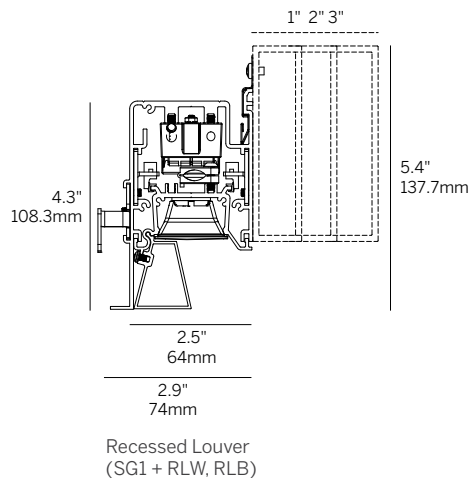
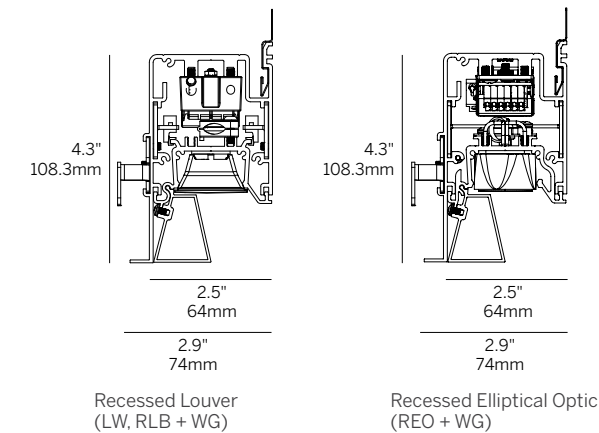
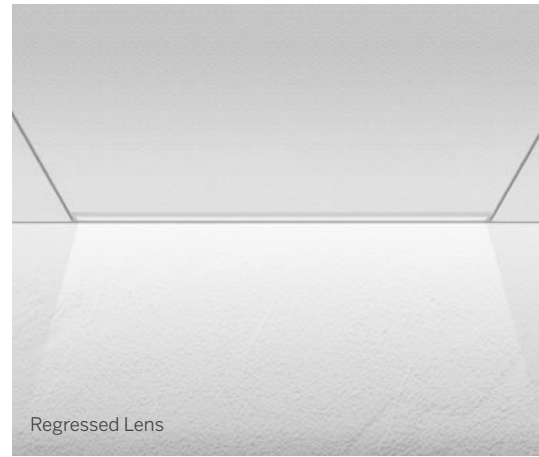

ProTools 60 Linear Wall Graze Recessed

Model	Fixation	Pattern	Length ²	CRI/CCT	Optic ³	Beam	Power ⁴	Driver ⁵	Housing Finish ⁶	Options
WG-60PTLWG	RPT	S	24	927	RLW	WG	P1	E1	W	CP
WG-60PTLSG1	RBT	PI ¹	48	930	RLB		P2	L1	B	EM
WG-60PTLSG2	RGT9	PO ¹	96	935	REO		P3	POE	S	NYC
WG-60PTLSG3	RGT15		XX ³	940			P4	BT DALI	F	TF

Model

- WG-60PTLWG = ProTools 60 Linear Wall Graze
- WG-60PTLSG1 = ProTools 60 Linear Soft Graze 1" extension
- WG-60PTLSG2 = ProTools 60 Linear Soft Graze 2" extension
- WG-60PTLSG3 = ProTools 60 Linear Soft Graze 3" extension

Fixation

- RPT = Recessed plaster trim
- RBT = Recessed trim for hard ceiling
- RGT9 = Recessed trim for 9/16" grid
- RGT15 = Recessed trim for 15/16" grid
- RGTS = Recessed trim for slot grid

Pattern

- S = Straight run
- PI = Standard patterns 2, 3 or 4 sided with 90° inside corners on the same plane¹
- PO = Standard patterns 2, 3 or 4 sided with 90° outside corners on the same plane¹

Length²

- 24 = 24"
- 48 = 48"
- 96 = 96"
- XX = Specify inches to the nearest 0.25"³

CRI / CCT (90+ CRI minimum)

- 927 = 2700K
- 930 = 3000K
- 935 = 3500K
- 940 = 4000K

Optic³

- RLW = Recessed louver white (supplied with white reflectors standard)
- RLB = Recessed louver black (supplied with black reflectors only)
- REO = Recessed elliptical optic

Beam

- WG = Wall Graze

Power⁴

- P1 = 3W/ft
- P2 = 6W/ft
- P3 = 10W/ft
- P4 = 15W/ft

Driver⁵

- E1 = EldoLED 0.1% dimming, 0-10V (120-277V)
- L1 = Lutron 1% dimming, Ecosystem (120-277V)
- PoE = Power over Ethernet
- BT = Wireless CAS – Casambi (Must specify BT with E1 or DALI)
- DALI = EldoLED Dali DT8 0.1% (120-277V)

Housing / Trim Finish (Includes kick reflector)⁶

- W = White, 15% gloss, RAL 9003 / Tiger Drylac 49/11350 (standard)
- B = Black, 15% gloss, RAL 9005 / Tiger Drylac 44/90053
- S = Silver, 15% gloss, RAL 9006 / Tiger Drylac 49/90500
- F = Custom finished trim, specify RAL

Options

- CP = Chicago Plenum Rated
- EM = Emergency (remote)
- NYC = 6' whip per run
- TF = Top feed

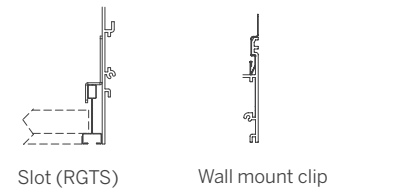
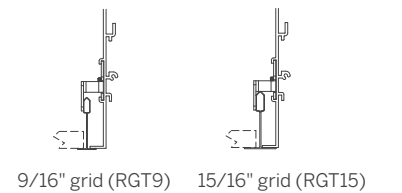
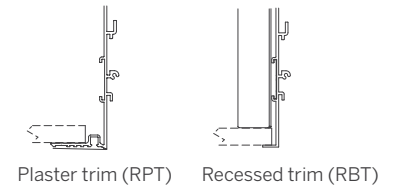

Polar Plots

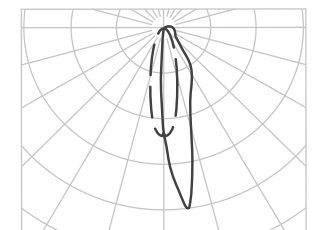

RLW-WG-...-W

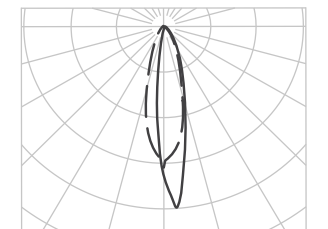

RLB-WG-...-W

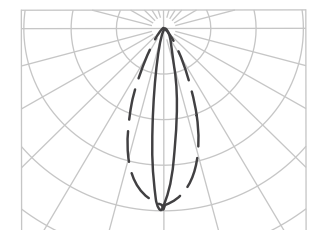

REO-WG-...-W-W

Whitegoods reserves the right to change any information without prior notice.

Notes

- See pattern spec sheet.
- Individual fixture lengths less than 2' may require remote driver.
- Specify Lensed products to nearest 0.25". Specify Louvered and Tuneable White products in 12" increments for continuous light. Louver supplied in 12" increments, balance of the run will have recessed blank covers on ends.
- Refer to specsheet for delivered lumen data for all product configurations.
- See power supply page for details.
- See Tiger Drylac color chart: inter-lux.com/tiger



Photo credits

inside cover - page 1, 30 - 31

project William and Mary, Sadler West
location Williamsburg, VA
architect Grimm + Parker Architects
photography Halkin Mason Photography LLC

page 3

project The Core, Eden Project
location Cornwall, UK
architect Grimshaw Architects
lighting design Mindseye
photography Andy Spain

page 4 - 5, 20 - 21

project American Bankers Association
location Washington, DC
architect OTJ Architects
lighting design CM Kling
photography Trent Bell

page 6 - 7, 8

project Corporate HQ
location Lehi, Utah
architect Gensler
photography Ryan Gobuty

page 22

project Carb
location Washington, DC
architect Alliance Architecture
lighting design MCLA
photography Robert Benson

page 32 - 33

project Northern Trust – 333 Wabash
location Chicago, IL
architect HED
photography Hall + Merrick+McCaugherty Photographers

page 34 - 35, 54 - 55, 60 - 61

project Venable LLP
location Washington, DC
architect Alliance Architecture
lighting design MCLA
photography Eric Laignel

page 36 - 37

project 575 Herndon Parkway
location Herndon, VA
architect DBI Architects
photography Galen Photography

page 56 - 57

project IDA Headquarters
location Washington, DC
architect KGD Architecture
photography Kristopher Ilich

page 58 - 59

project ModivCare
location Denver, CO
lighting design ME Engineers
photography Jess Blackwell

page 76 - 77

project Rockville Town Center
location Rockville, MD
architect R2L:Architects, PLLC
photography Steve Lerum, Inter-lux

page 79

project Senova Dental Practice
location London, UK
architect FLACQ Architects
photography Andy Spain



The application of light to the surfaces around us is a critical factor in our perception of any space.

When proper consideration is given to the architecture, function and the desired atmosphere, lighting can become a truly integrated part of the overall environment being created, often unseen although defining and enhancing the space.