

20 Linear



whitegoods











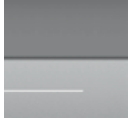







whitegoods

Whitegoods has developed the most complete range of small scale linear fittings and integration profiles to illuminate any interior space. The 20 Linear range was conceived to apply the right quality and quantity of illumination to the space while minimizing the source of the light and eliminating obtrusive light spill - all while holding true to our brand philosophy:

- Reduction of detail
- Seamless architectural integration
- Logical, modular systems and families of products
- Ease of specification, installation and maintenance

Contents

	20 Linear Recessed	66		20 Linear Recessed Flush	84
	20 Linear Surface	68		20 Linear Recessed Regressed	86
	20 Linear Suspended	70		20 Linear Perimeter Flush	88
	20 Linear Direct/Indirect Suspended	72		20 Linear Perimeter Regressed	90
	20 Linear Direct/Indirect Surface Wall Mount	74		20 Linear Mini Edgeless Cove	92
	20 Linear Wash Light Recessed	76		20 Linear Mini Z Cove	94
	20 Linear Wash Light Surface	78		20 Linear Under Cabinet	96
	20 Linear Wash Light Suspended	80		20 Linear Wand	98
	20 Linear Wash Light Semi-Recessed	82			





1925

In celebration of its 50th anniversary, ABA established the Educational Foundation with a \$500,000 endowment.

1943

ABA supports the use of what is known as the "ABA method" for teaching law, which emphasizes practical skills and problem-solving.

1963

ABA approves the first law school accreditation standards, which are now the basis for all law school accreditation in the United States.

1971

ABA approves the first law school accreditation standards for law schools in Canada, which are now the basis for all law school accreditation in Canada.

1956

ABA approves the first law school accreditation standards for law schools in the United States, which are now the basis for all law school accreditation in the United States.

1968

ABA approves the first law school accreditation standards for law schools in the United States, which are now the basis for all law school accreditation in the United States.

OSIP Number

000000000



TEST
IT OUT

LIVING OUR
PURPOSE

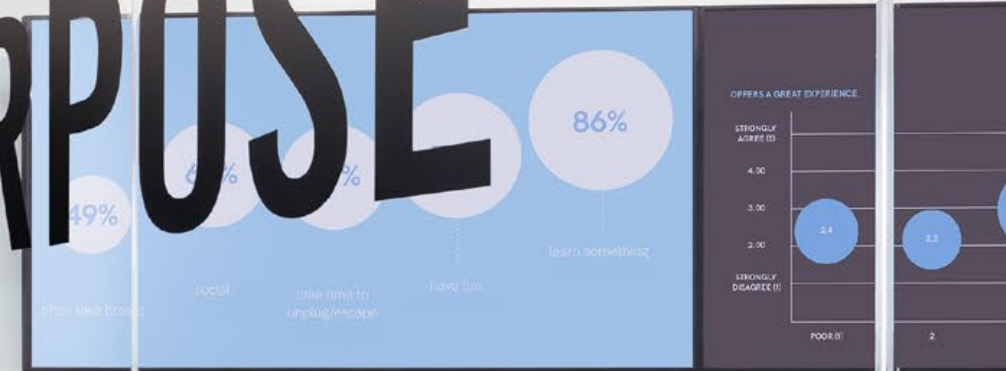

Brightness is in the eye of the beholder

Our perception of the 'brightness' of a space is primarily based on what we see at a glance as we scan around us. In architecture this is often walls and other vertical surfaces. Therefore, how well the walls are illuminated at approximately eye level is the key factor in our determination of how well a space is lit.

Within such a space then, which surfaces and / or planes should be revealed in order to support the architectural concept?

What opportunities are there to bring light to these surfaces?

Where should the light come from?

What should the properties of that light be (how much, how focused, what spread of light, and at what angle should it fall onto the surface...)?

Whitegoods provides tools for the designer to address these questions and answer them with light, while the luminaires make the absolute minimum visual impact on the space.

Whitegoods fixtures provide all-round vertical illumination with high angle secondary diffuse light, filling the volume with light, creating visual brightness and visual comfort too. An array of optical accessories and integration profiles further expands the uses to include grazing, cove and perimeter lighting solutions.

20 Linear

Whitegoods is a language of light developed to bring illumination to surfaces in the simplest way possible. We believe in 'luminous surfaces and planes of light'.

It is critical to our approach that our luminaires have a minimal visual impact. Their job is to reveal the surfaces around them, while seamlessly integrating with the architectural envelope.

Whitegoods offers the discerning specifier a range of lighting tools to facilitate this approach. The 20 Linear range is the most flexible architectural lighting tool developed to allow designers the freedom to work with light in an instinctive way.

Utilizing the small form factor, the range includes a family of profiles all based around the same high performance linear LED technology, developed by Whitegoods specifically for this product line. Coves, coffers, perimeter wash and seamless lines, all beautifully rendered with smooth even light.

This is Whitegoods: this is 20 Linear.







20 Linear

Applications include:

- General illumination
- Wall wash
- Wall graze
- Accent lighting
- Direct/indirect lighting
- Cove lighting
- Perimeter lighting

Recessed, surface, suspended and wall mounted to any surface type.

The ability to utilize the same form and technology throughout any multipurpose space to deliver a cohesive language of light.

Small scale to integrate invisibly into the architecture, close to the surface being illuminated for greater energy efficiency and minimal spill light.

Specifiable in standard and completely tailored lengths to fit any space.

So much performance from such a small luminaire.

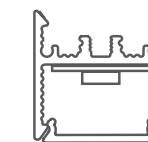

Introduction

Application Guide

Whitegoods products are extremely versatile and can be integrated in a multitude of ways. Within this section of the book, you will find examples of a range of luminaires used in varying applications, including examples of the detailing used to achieve them.

Product Specifications

Within this section, you will find detailed information for all Whitegoods products, including key features, selectable options, critical dimensions, mounting possibilities and aesthetic choices. The information you need to help select the perfect luminaire for your application, without the clutter of every last technical detail. But, we also know that ultimately you and your team will need all the technical details, so we have developed a unique way to access and share detailed product specifications. Have a look at the section below, which explains how it works. It's simple and quick.

Design Guide

We have provided performance data and characteristics for Whitegoods luminaires, as well as providing expected light levels and typical scenarios based on set parameters. The results are intended as a handy reference to help the specifier plan a project quickly, efficiently and with confidence.



20 Linear Recessed

Whitegoods has developed a unique and innovative way to access and share product specifications, design guides and photometric files of the products you select.

Simply click the technical information button and you will be taken to the product page, where you can view and download technical information.



20 Linear Modularity

Whitegoods utilizes modularity throughout the range to ensure maximum efficiency of design, manufacture and maintenance. For the specifier this means absolute consistency across all product types and applications, as well as making sense economically.

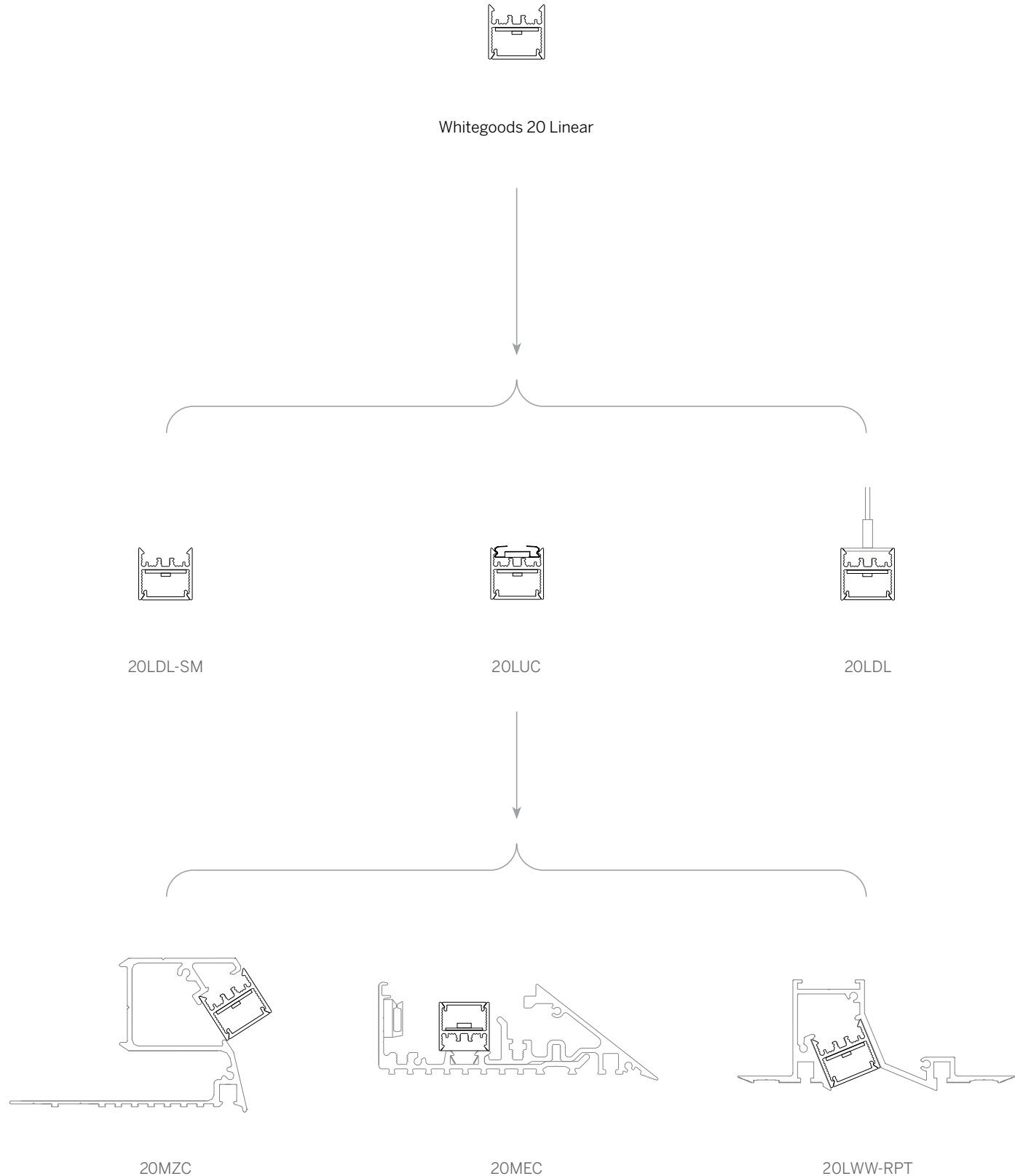
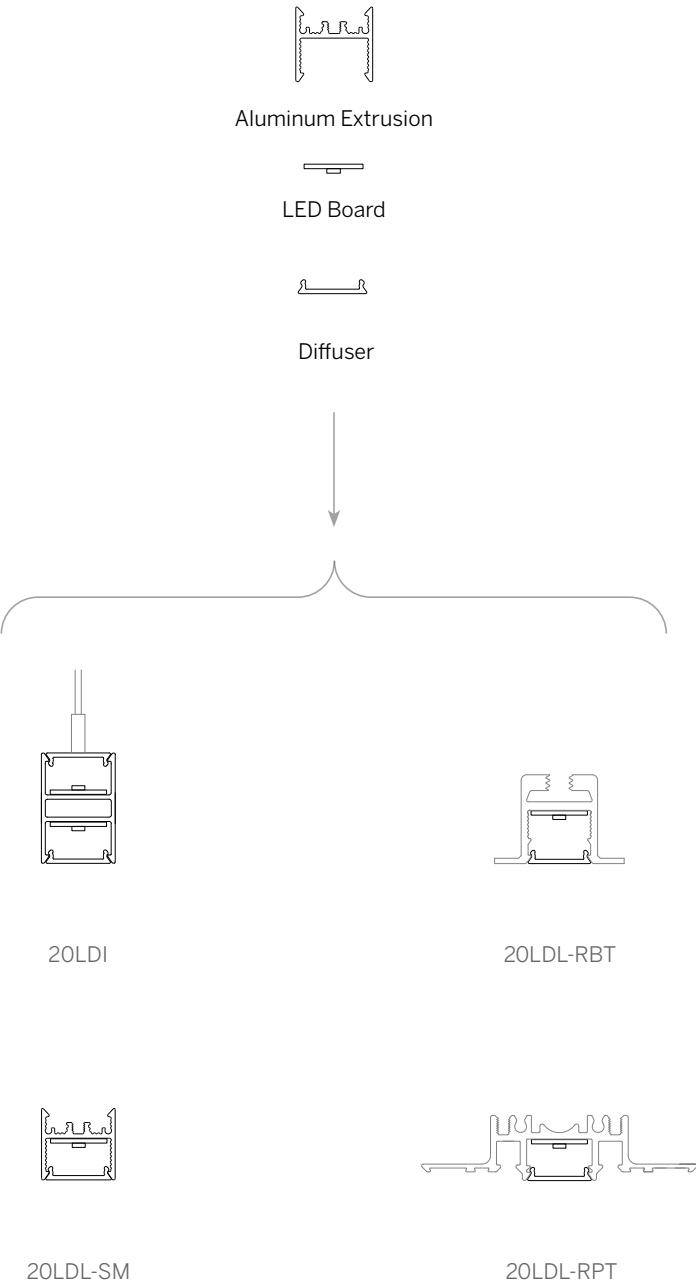



Whitegoods developed a specific LED light source optimized for our linear products, using the highest performance and quality LED devices available on a form factor that best fits our product mechanically and electronically. We use this LED throughout our entire range of 20 Linear, Linear, Cove and Perimeter lighting systems. Additionally, we standardize on the highest quality drivers and control devices to ensure that our system works at peak performance and consistency mile after mile.

Whitegoods products are developed in a modular fashion that allows easy repair or replacement of the light source without upsetting the installation. We term this: future proofing.



- Replaceable light source guarantees sustainability.
- Available in any continuous length to accommodate exacting installations.
- Multiple wattages and lumen output for maximum flexibility within any application.
- Constant Voltage, 90+ CRI, 3 step MacAdam.
- Four standard color temperatures from 2700K-4000K
- Compatible with all common dimmer and control standards such as 0-10V, 3-wire, forward-phase with neutral, ELV, DALI and DMX.
- High efficiency design delivers up to 90 lumens/watt
- Used throughout Whitegoods 20 Linear, Linear, Cove and Perimeter products for color and performance consistency.
- 5-year warranty.







20 Linear Lenses/Accessories

To further expand the applications that can be successfully achieved with the 20 Linear, Whitegoods continues to develop optical accessories that increase efficiency, tighten the beam spread and shield the light source. The integration profiles available all accommodate optical accessories to allow the designer to combine attributes to successfully satisfy the application at hand.



Opal Diffuser provides even, continuous line of light and general illumination (OD)



Satin Clear Diffuser for high efficiency soft edge beam, general illumination (SD)



Micro-prismatic lens for high efficiency and lower brightness, general illumination (MPL)



Round Opal Diffuser, 1" diameter for general illumination (ROD)



Block Diffuser of satin acrylic for general illumination and decorative effect (BD)



45 Degree Louver in black or white for extreme low brightness (LL45B / LL45W / LL45S)



Narrow Lens optic for wall grazing applications (NL16)



20 Linear Interactive Product Overview

click images to open product pages

Direct



20LDL-RPT
Plaster Trim
1-2-5



20LDL-RBT
Bezel Trim
1-2-5-6



20LDL-RGT
Grid Trim
1-2-5-6



20LDL-SM
Surface
1-2-3-4-5-6-7

Direct/Indirect



20LDL
Suspended
1-2-3-4-5-6-7

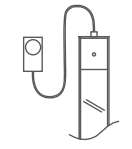

20LUC
Under Cabinet
1-2-5



20LDI
Suspended
Direct/Indirect
1-2-3-4-5-6-7



20LDI-SW
Surface
Wall Mounted
Direct/Indirect
1-2-3-4-5

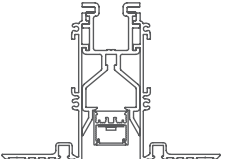

20LRF-RPT
Recessed Flush
Plaster Trim
1-2-3-4-5-6

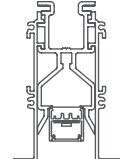

20LRF-RBT
Recessed Flush
Bezel Trim
1-2-3-4-5-6

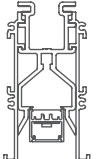

20LRF-RGT
Recessed Flush
Return Trim
1-2-3-4-5-6

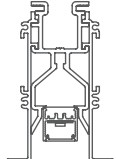

20LRF-RRT
Recessed Flush
Grid Trim
1-2-3-4-5-6

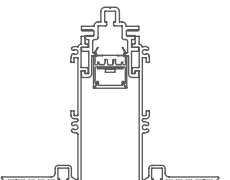

20LRR-RPT
Recessed Regressed
Plaster Trim
1-2-3-4-5

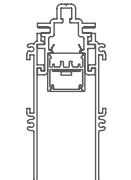

20LRR-RBT
Recessed Regressed
Bezel Trim
1-2-3-4-5

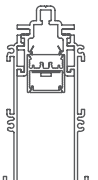

20LRF-RGT
Recessed Regressed
Return Trim
1-2-3-4-5

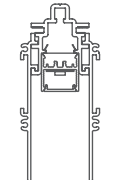

20LRF-RRT
Recessed Regressed
Grid Trim
1-2-3-4-5

Wash

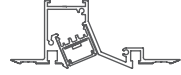

20LWW-RPT
Wash Light
Recessed
Plaster Trim
1-2-5



20LWW-RBT
Wash Light
Recessed
Bezel Trim
1-2-5



20LWW-SM
Wash Light
Surface
1-2-5



20LWW-SRPT
Wash Light
Semi-Recessed
Plaster Trim
1-2-5

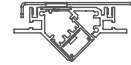

20LWW-SRBT
Wash Light
Semi-Recessed
Bezel Trim
1-2-5

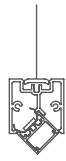

20LWW
Wash Light
Suspended
1-2-5

Perimeter

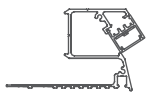

20MZC
20 Linear
Mini Z Cove
1-2-5

Cove

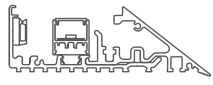

20MEC
20 Linear
Mini Edgeless Cove
1-2-5

NOMINAL LUMENS [lm / ft] CV1.2 STATIC WHITE				
		POWER [W / ft]		
		L [3]	M [6]	H [10]
CCT	927	303	606	1061
	930	330	659	1153
	935	391	783	1370
	940	465	930	1628
	WD ¹	232	482	697
	RGBW ²	-	-	394

1 WD: L = 2.7 W/ft, M = 5.5 W/ft, H = 7.6 W/ft
2 RGBW 8 W/ft, nominal lumens based on 3000K White LED

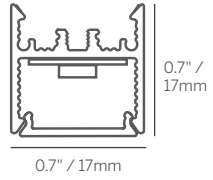

0.7" / 17mm

Perimeter

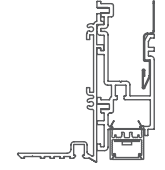

20LPF-RPT
Flush Plaster Trim
1-2-5

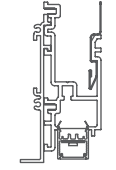

20LPF-RBT
Flush Bezel Trim
1-2-5

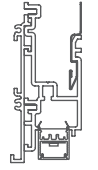

20LPF-RGT
Flush Return Trim
1-2-5

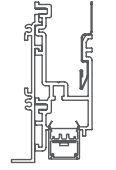

20LPF-RRT
Flush Grid Trim
1-2-5

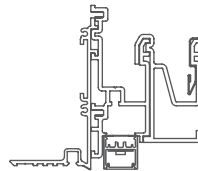

20LPFSG-RPT
Flush Plaster Trim
Soft-graze
1-2-5

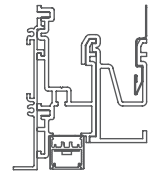

20LPFSG-RBT
Flush Bezel Trim
Soft-graze
1-2-5

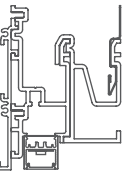

20LPFSG-RRT
Flush Return Trim
Soft-graze
1-2-5

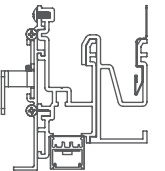

20LPFSG-RGT
Flush Grid Trim
Soft-graze
1-2-5

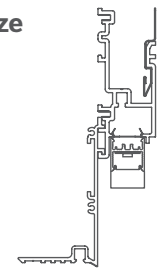

20LPR-RPT
Regressed Plaster Trim
1-2-3-4-5

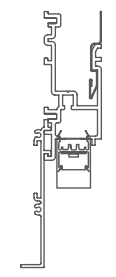

20LPR-RBT
Regressed Bezel Trim
1-2-3-4-5

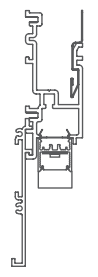

20LPR-RRT
Regressed Return Trim
1-2-3-4-5

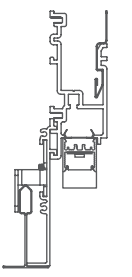

20LPR-RGT
Regressed Grid Trim
1-2-3-4-5

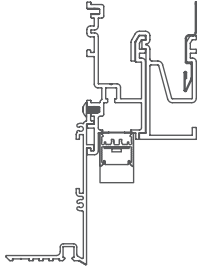

20LPRSG-RPT
Regressed Plaster Trim
Soft-graze
1-2-3-4-5

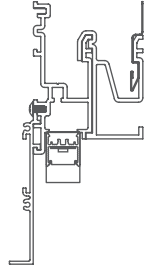

20LPRSG-RBT
Regressed Bezel Trim
Soft-graze
1-2-3-4-5

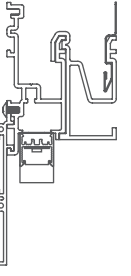

20LPRSG-RRT
Regressed Return Trim
Soft-graze
1-2-3-4-5

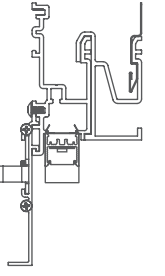

20LPRSG-RGT
Regressed Grid Trim
Soft-graze
1-2-3-4-5

RGBW

The ability to add dynamic color-changing to a very small scale product is an exclusive benefit of LED lighting. When used in conjunction with the 20 Linear range, colored light can be introduced into the space for accent, health and mood-setting results.



Warm Dim

Warm Dim lighting provides LED dimming and warm LED lights virtually indistinguishable from an incandescent light source. Designed to precisely mimic the black body curve of a standard 100W A19 lamp by gradually transitioning from 1800K to 3000K.

Color Temperature	Description	Typical Usage
3000K	Neutral Warm	Office, Residential
2700K	Warm: Halogen Incandescent	Residential, Hotel
1800K	Very Warm Incandescent	Residential

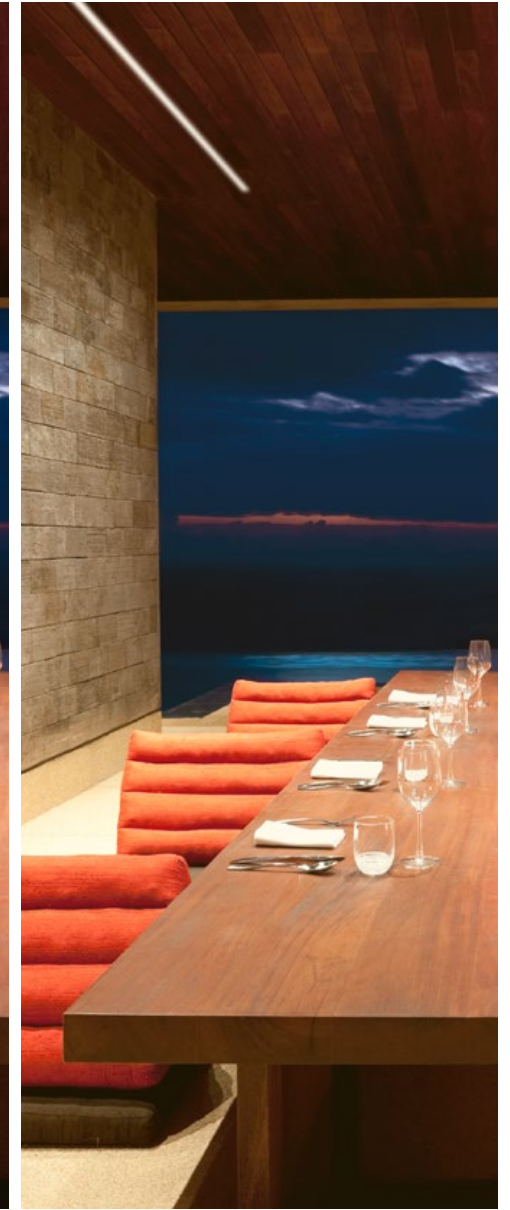



Whitegoods Wand

The 20 Linear family of products from Whitegoods are incredibly flexible lighting tools. We have developed the Wand to allow specifiers to see for themselves just how flexible and multi talented the 20 Linear range really is. Direct it up, down, vertically, horizontally, adjacent to a wall, the floor, a frosted panel or tuck it under a shelf. You'll soon find this is an indispensable tool for roughing out your ideas with light. The Whitegoods Wand is provided with plenty of cable, a simple plug-in driver and magnets to snap to metal surfaces.

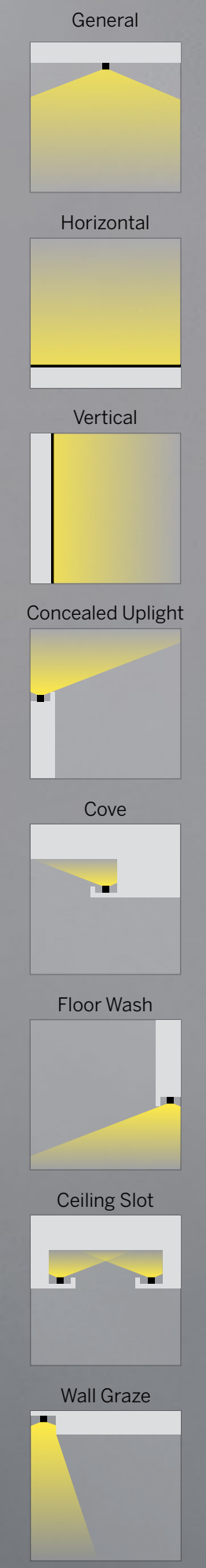



PROJECT[21]

Helping you overcome a critical task
project and taking on the most
complex, long-term, high-stakes
challenges and pushing you to achieve
goals of the best team.

FOR THE FUTURE
SMART
TRANSFORMING



Application Guide

Whitegoods 20 Linear products are extremely versatile and can be integrated in a multitude of ways. Within this section of the book, you will find examples of a 20 Linear luminaires used in varying applications, including examples of the detailing used to achieve them.

In the following pages, you can find out how Whitegoods 20 Linear products have been used to create minimal, continuous lines of light in the ceiling plane with illuminated corners, to integrate into a multitude of surface types, or create perimeter or indirect 'pockets' of light with the source of illumination completely concealed from view.

In short, Whitegoods 20 Linear luminaires and integration options allow the designer free reign when it comes to imagining innovative and fresh ways to breath light into a space. You bring the vision to us, and we help you realize it.

Whitegoods is seamless, architectural integration.



Applications

Downlight

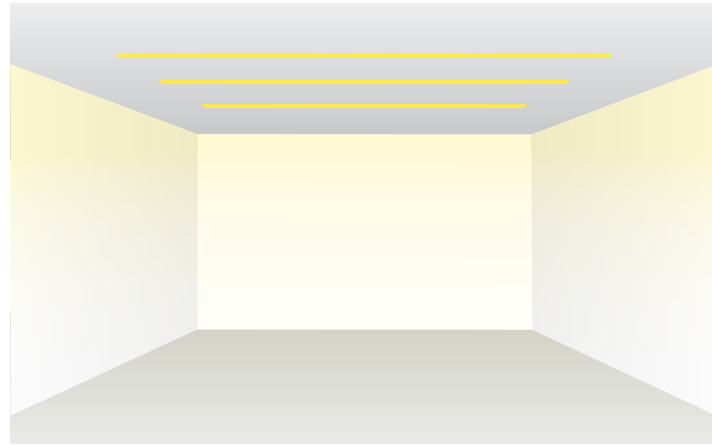

Perhaps the most common lighting solution utilized for general area lighting, arranging a group of lights in a grid to give even illumination to the surface below. Of course, the popularity of a technique is not always a sign of best practice, and in this case it typically has more to do with economy and ease of implementation.

However, when applied to a space with some consideration it can be an effective technique. One thing to consider for this type of solution is "how much light will fall on the walls?". A space can have a lot of light being delivered into it, but if the walls are not sufficiently illuminated, there is a good chance that the space will feel gloomy, even though there is plenty of light falling on horizontal surfaces like desks or the floor.

Fortunately, many Whitegoods luminaires have good 'high angle distribution', which can help to deal with this common issue (see Washlight). Also note that narrow optic accessories can further concentrate or restrict the light to the intended surfaces.

Tip

Look for Whitegoods product codes which include "LDL" and "LD", throughout this book to find products ideal for Downlight applications.

Washlight

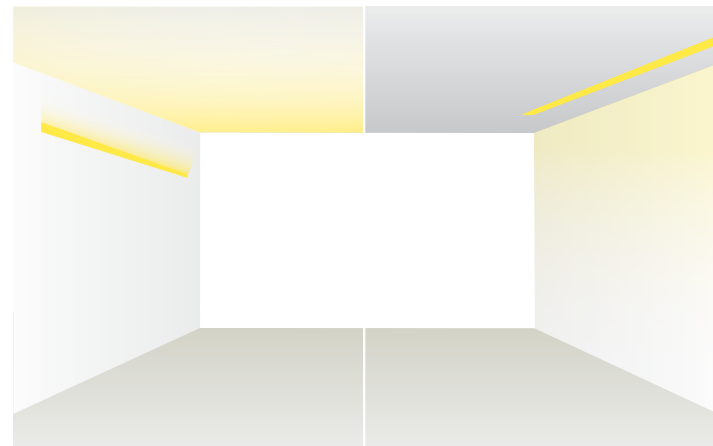

The aim of wall washing, or in fact washing any surface with light (wall, ceiling or floor), is to create an even 'wash' of light across the surface. The wall wash is a great way to introduce light into a room as the brightness of the vertical surfaces around us play a crucial role in our perception of a space. You can use linear sources which emit a wide, even beam of light directed towards the intended surface.

Consider all of the mounting opportunities afforded by the 20 Linear washlights: recessed, semi-recessed, surface and suspended

Tip

Look for Whitegoods product codes which include "WW", "LWW", throughout this book to find products ideal for Washlight applications.

Grazing

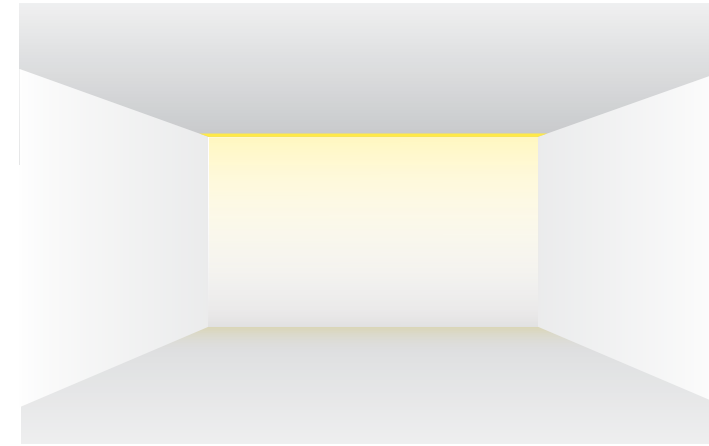

Surface Grazing is typically used to reveal and highlight textured feature surfaces such as stone, brick, wood and fabric to name a few. To achieve this, a focused narrow beam of light flows across the entire wall from top to bottom, delivering a sheet of light across the featured surface.

The design may be a recessed niche at the top of the wall with a surface mounted grazing luminaire, or one of several 20 Linear recessed profiles that integrate into any ceiling type and project an even sheet of light down the wall.

Either way the finished wall should be allowed to go past and above the ceiling plane so that the entire wall is illuminated top to bottom.

Tip

Look for Whitegoods linear product codes which include "LDL", "LD", "LPR", "LRR" with "NL16" or "LL45x", throughout this book to find products ideal for Grazing applications.

Perimeter

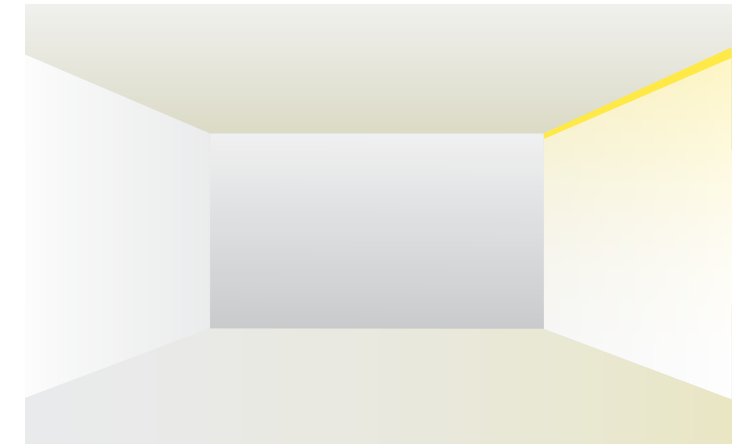

Another simple and highly effective way to add natural feeling light into a space is via a concealed linear light source detailed into the intersection of the wall and ceiling. This luminaire, typically recessed into the ceiling and providing an even illumination from a homogeneously illuminated lens, gives definition to the space, and functional light on the perimeter.

A perfect application to define lobby and conference space perimeters, as well as vanity light over a mirror by virtue of the fact that the source of light is hidden from normal viewing angles (including mirror reflection), while functional illumination is distributed down the wall and into the space.

The 20 Linear Perimeter, with its minimal aperture provides the perfect detail for perimeter applications.

Tip

Look for Whitegoods product codes which include "LPF", "LPR", "MEC", "MZC", throughout this book to find products ideal for Perimeter applications.

Applications

Direct/Indirect

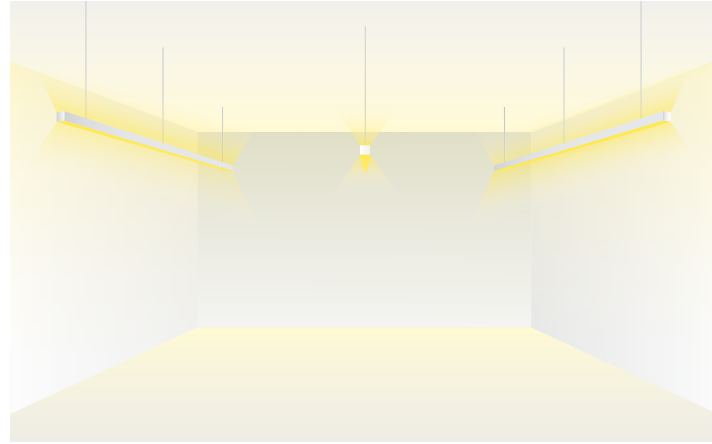

A room can be very well-lit by combining two lighting elements to achieve a perfect balance between an indirect uplight component, lifting the space and making it feel bright, and a direct component, delivering the right amount of light just where it is needed.

Pendant lights can do this well, emitting light in both directions. As long as there is enough space above them for the light to spread out, an even effect can be achieved. Also, being suspended pendant means that the direct light portion is inevitably closer to the task level, or work surface. This means that less light is required to achieve the required light levels.

Wall mounting a direct/indirect luminaire is another way to deliver volume and task lighting to a space from the perimeter. It has the added benefit of visually expanding the space horizontally as well as vertically.

Tip

Look for Whitegoods product codes which include "LDI" throughout this book to find products ideal for Direct Indirect applications.

Cove

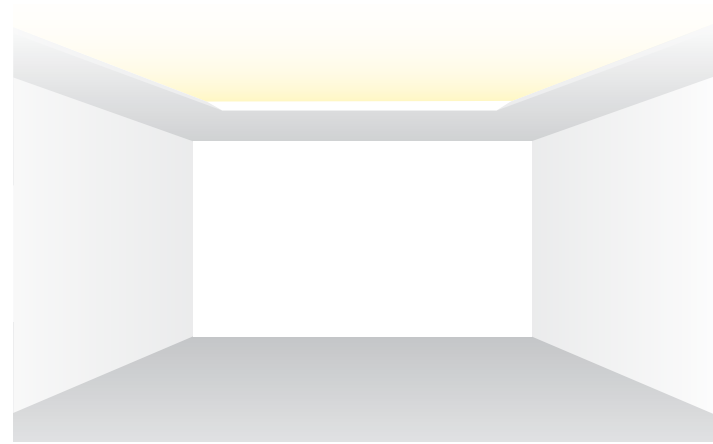

When soft diffuse light comes from above, a natural feel is imparted to a space. It is understandable when you consider that the vast majority of natural light that we experience comes to us from above.

Creating a cove within the ceiling provides an opportunity to deliver light in this way. Although the technique does require some ceiling depth, it is no more than is typically required for recessed downlights, for example, 6" - 12" between the luminaire and the underside of the surface above will give good results.

Another way to provide reflected light into the space would be to detail a cove within 2'-3' from a wall, allowing the cove light to reflect off the ceiling plane and be redirected to the wall, evenly washing the vertical surface

This technique suits hospitality and residential settings especially well, and when controlled via a dimmer, can provide a range of moods from bright and fresh right through to cozy and intimate.

Uplighting can be a very effective way to make a space feel well-lit, even though actual light levels achieved in the room can be lower overall. This is because lighting the ceiling helps a room feel light and airy, being similar to the way we experience most natural light: coming from a wide area above. Yes, the sky! Also, much of the light reflected back from the ceiling will find its way to the walls, again helping with the sense of light within the space overall.

Tip

Look for Whitegoods linear product codes which include "LDL", "MEC", "MZC", throughout this book to find products ideal for Cove applications.



FLOOR
2

2

2

2



Pennsylvania
Welcomes
You

DIVINE
EXPERIENCE

Ma



20 Linear Suspended, within a wood slat ceiling system

The 20 Linear family of luminaires is incredibly flexible. With a suspension mounted fixture (20LDL), the designer has the freedom to integrate it neatly in all kinds of applications.

Here it has been used within a semi-open slatted ceiling system, where the luminaire replaces a wooden slat, delivering the required light from a simple clean element which compliments the architectural language and rhythm of the space.

Whitegoods: Reduction of detail.

Section of Ceiling

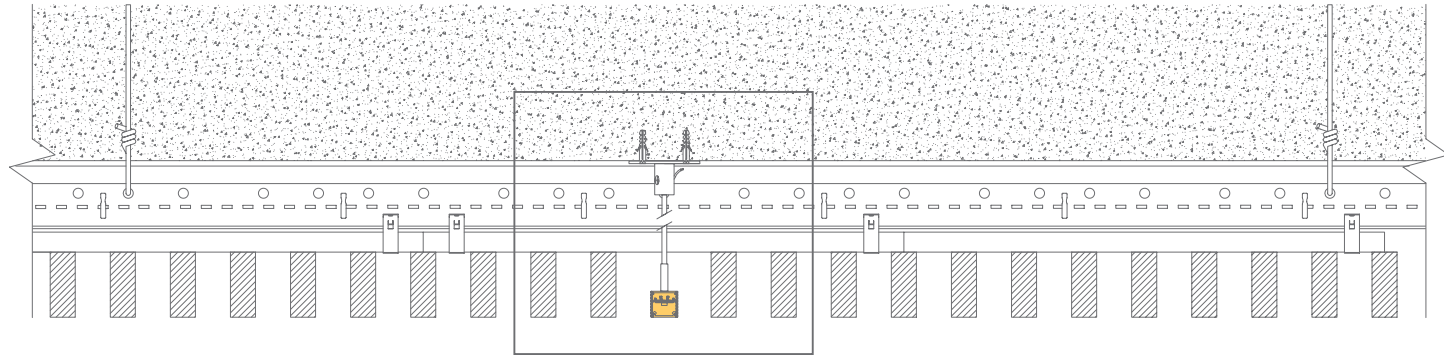

Detail @ 1:2

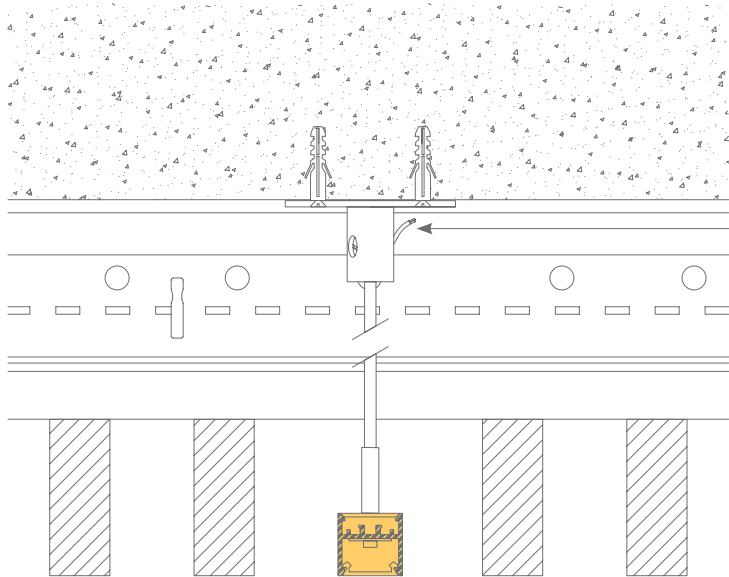

Hard Ceiling Suspension
with Power Cable





20 Linear Surface Mount, recessed into a 'pocket' detail

In hospitality environments, such as this restaurant, it is often preferable to keep general light levels relatively low, while still delivering the necessary light where needed. Keeping the light source close to the surface to be lit can mean less light is required overall.

As a surface mounted fixture, the 20 Linear (20LDL-SM) can be utilized in any number of ways. Here it has been mounted within a pocket detail routed into a brick surface, delivering the required light to the staircase.

Once the pocket is formed, mounting clips are simply screw fixed in place, and the luminaire snaps into the slot, concealing the feed cables behind.

Whitegoods: Ease of Installation.

Detail @ 1:2

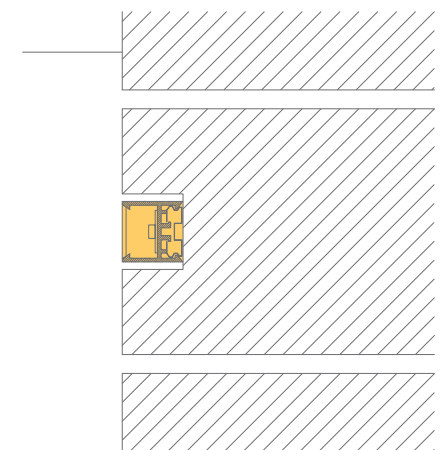

Elevation of Staircase

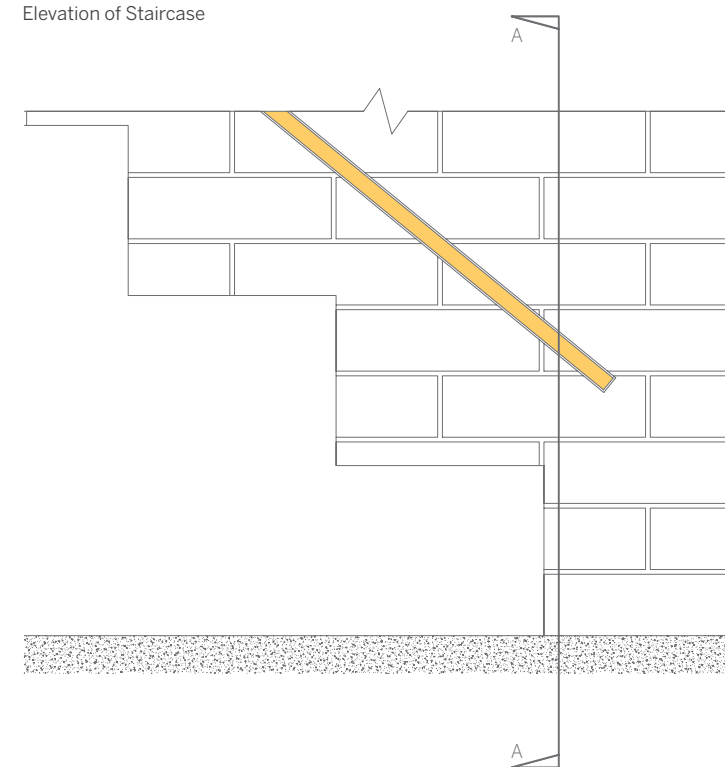

Section AA

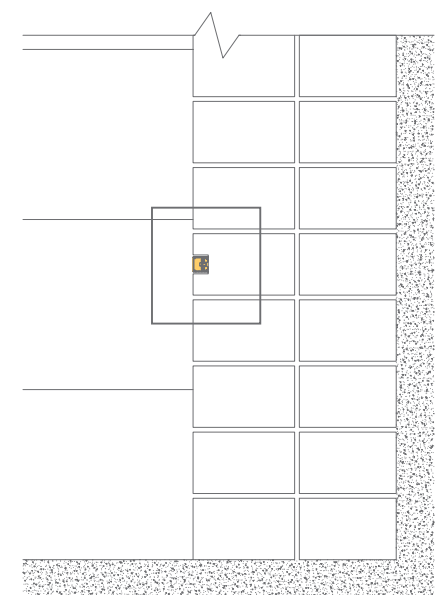

20 Linear Mini Z Cove, forming a perimeter wash detail

In this ultra-minimal space the architect wanted to see only the light, and none of the lighting equipment. 20 Linear Mini Z Cove with a Plaster Trim flange (20MZC-RPT) is a compact yet powerful tool where a designer wants to push a genuinely useful amount of light onto a surface, especially when there is very little space available for the luminaire.

The precision extruded mounting profile has a crisp edge which completely integrates with the mounting surface to produce a perfect edge, behind which the 20 Linear 'insert' can be snapped into place, concealing all cabling in the dedicated channel behind it.

Whitegoods: Seamless architectural integration.

Ceiling Section Option A @ 1:2

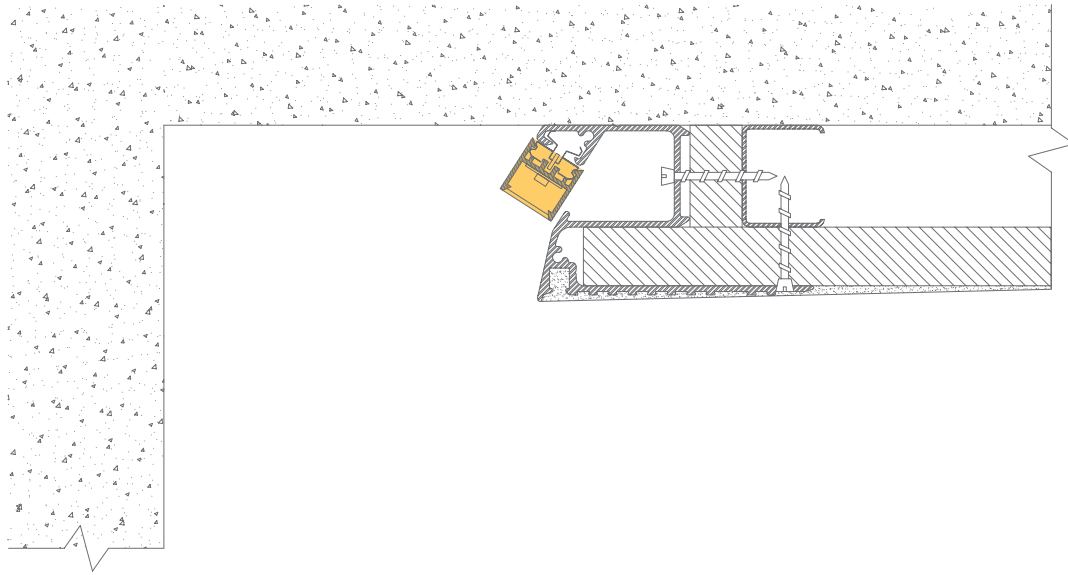

Ceiling Section Option B @ 1:2

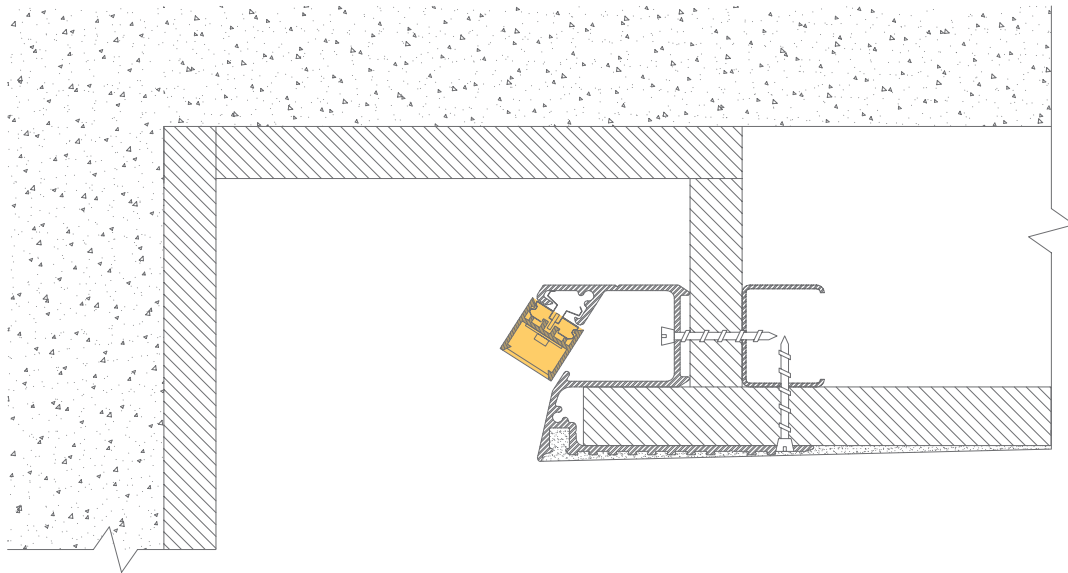



20 Linear Mini Edgeless Cove, in a wall-to-ceiling transition

The pressure is always on for architects and designers to create eye-catching spaces, especially within entrance lobbies. Here the architect has conceived an overlapping surface where light flows calmly from each layer of the wall and ceiling. Whitegoods helped to detail the integration of a knife edge cove luminaire, completely shielding the light source from any viewing angle.

20 Linear Mini Edgeless Cove (20MEC-RPT) has been used to create the impression that the surfaces have no thickness. The mounting extrusion has a raked back front face meaning that the finished edge is perfectly straight and has no visible upstand from almost any angle.

Once the concept was agreed upon, Whitegoods produced the necessary drawings to validate the approach, and provided all the detail drawings required for the architect to complete their construction drawings.

The mitered corners were prefabricated to minimize work for the contractor and ensure a perfect finish. The light unit can be easily removed if maintenance or an upgrade are ever required.

Whitegoods: Ease of specification, installation and maintenance.

Ceiling Section & Wall Plan Section

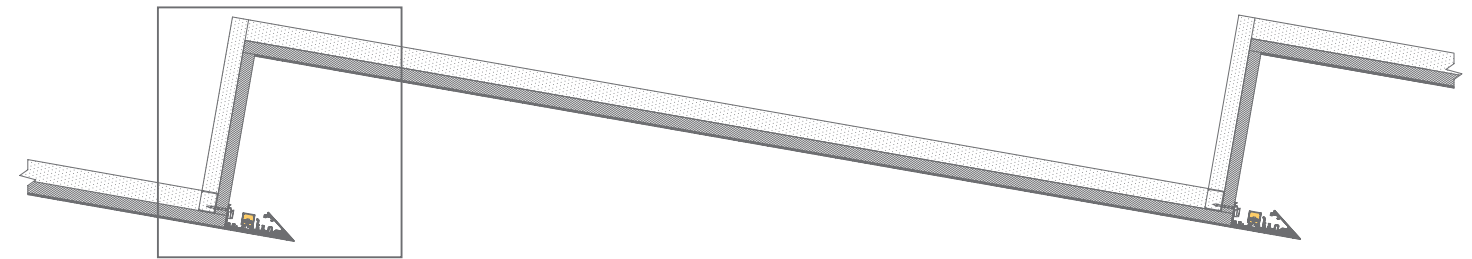

Detail of Ceiling Section @ 1:2

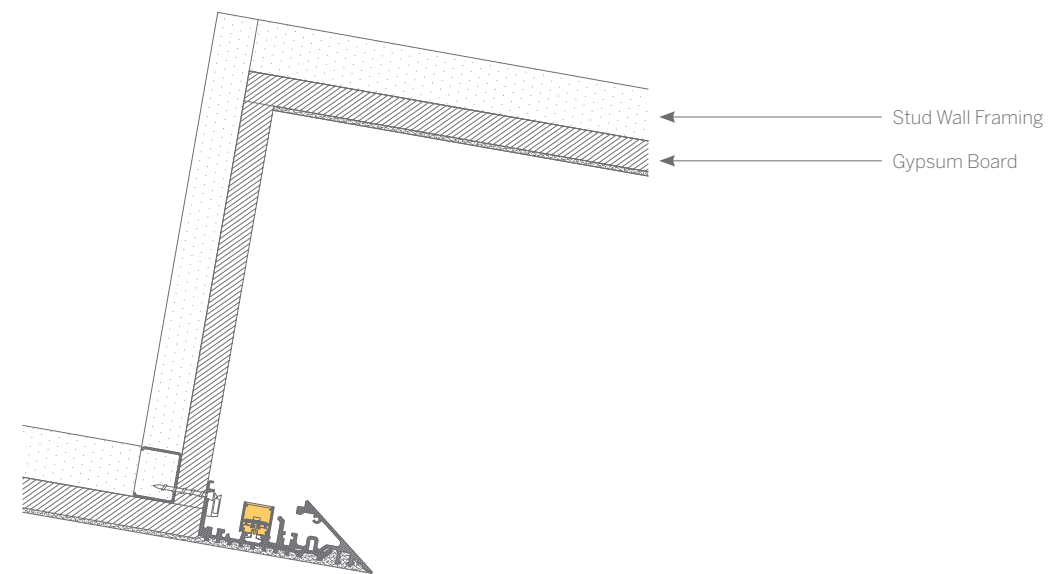



20 Linear Mini Z Cove, in concealed floor wash detail

Although typically used as a perimeter wash luminaire, here the 20 Linear Mini Z Cove (20MZC) is cleverly utilized to provide a subtle floor wash from a concealed recess at the foot of a wall.

Typically a standard linear luminaire would be installed up into a recess, therefore providing light only directly downward.

Due to the fixed angle achieved by the orientation of the 20 Linear Mini Z Cove in this application, plenty of light is washed right across the floor of the corridor.

Note that, although the form factor of the product is linear, it can be provided in segments, each with custom cut mitered joints to integrate into curved elements.

Plan View of the Curved wall and Section Detail

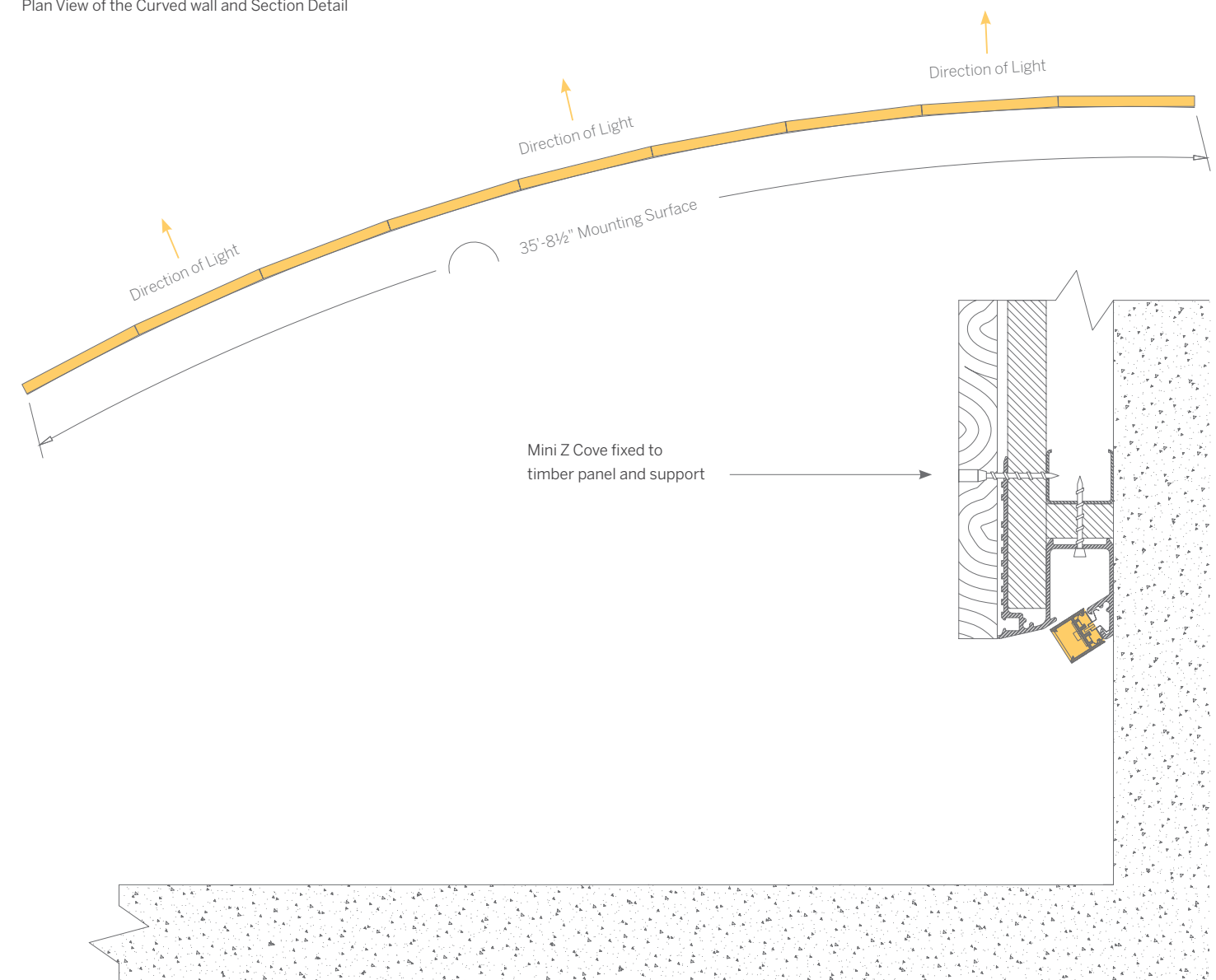

20 Linear, tailored to exact dimensions

In this demanding project, the designer has made good use of the 20 Linear's (20LDL-SM) ability to be supplied in any required dimension.

As the luminaires were integrated into a narrow overlap between intersecting ceiling panels, they needed to fit perfectly within each one. As can be seen from the illustration, there are 14 different lengths involved, and each luminaire was produced to a 1/4" accuracy to the available space.

The key to this unique level of tailorability is the technology designed into the Whitegoods linear LED boards, allowing us to make a continuous luminaire to any desired length.

Section Detail of Ceiling

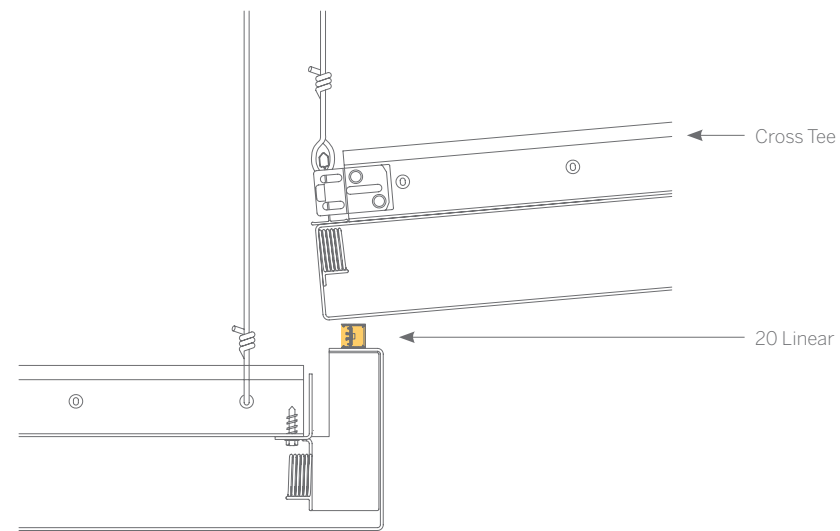

Plan of Ceiling

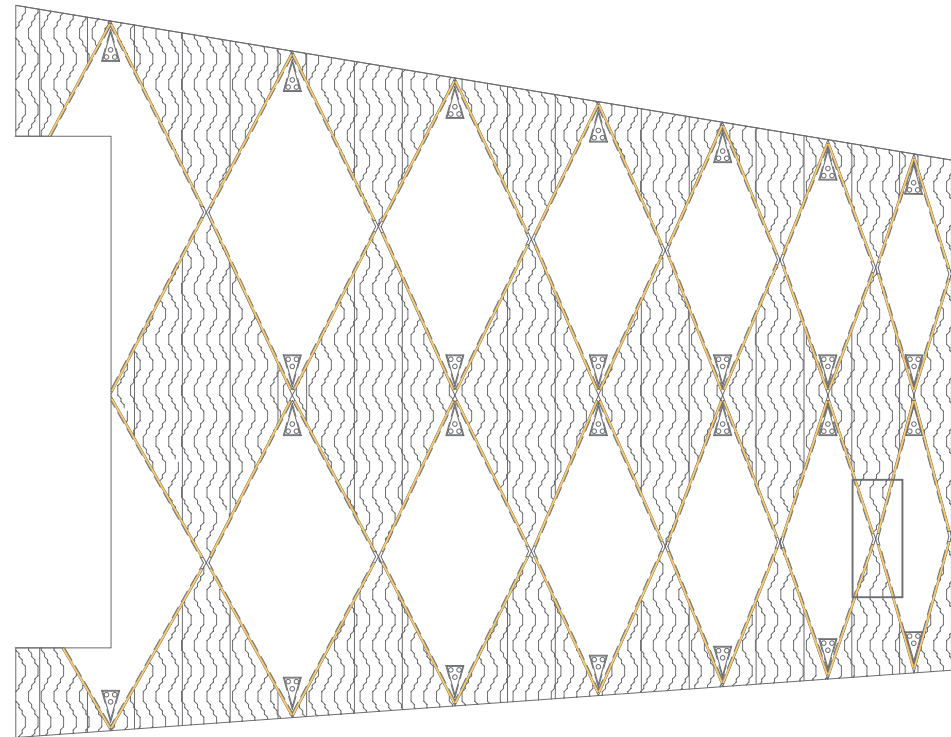

Close-Up of Ceiling Plan

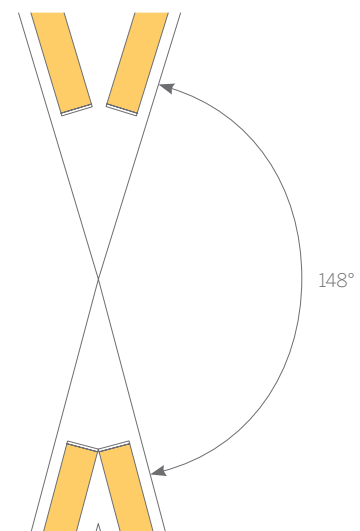

20 Linear, horizontal transition within skylight

A linear light source can deliver general light to a space, or specific light to a surface. It can also be used to create a deliberate visual element in a space and accentuate architecture.

In this project, the designer has used 20 Linear with Plaster Trim which has been recessed into the vertical surface of a series of skylights. In this way, light is delivered from the same architectural element during the hours of darkness as it is during daylight.

Whitegoods can supply detailed instructions on how to achieve all sorts of details, as well as supplying product factory-cut to exact lengths and ready to install.

Detail of 20 Linear integration

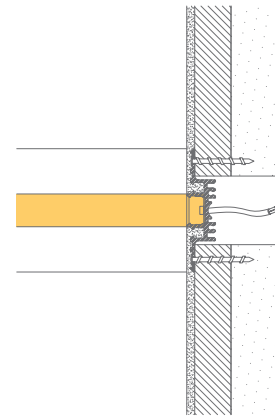

Section of Skylight Showing 20 Linear with Plaster Trim



Section in Plan View Showing Overlapping Fixtures



V

A
N
D
E
R
B
I
L
T

20 ^{MAX} ADELMAN

3 ^{ROBERT} CHATMAN

10 ^{STUE}

2 ^{PIPPIEN JR.}

4 ^{WRIGHT}

42 ^{MILLORA-BROWN}

0 ^{LAWRENCE}

21 ^{ROBBINS}

12 ^{THOMAS}

23 ^{MAHON}



**DELIVERING
RESULTS
THE RIGHT
WAY**

Product Specifications

20 Linear Recessed

- Continuous line of light in a 0.7" wide recessed luminaire.
- Trimless and bezel trim for seamless integration into any drywall, wood and metal surfaces.
- Trimless installation into drywall without disturbing the wall structure.
- Straight runs and complex configurations with factory corners in exact lengths as specified.
- Multiple distribution options.
- 90+ CRI, 3 Steps MacAdam delivering excellent color rendering.
- Choice of White, RGBW and Warm Dim to emulate incandescent.
- Identical LED technology used throughout all Whitegoods Linears, Coves and Perimeter products deliver consistent quality and performance throughout a project.
- Made in USA.
- 5-year warranty.

Housing	Precision extruded aluminum for true dimensions and tolerances Provided with all hardware for seamless integration into selected surface Standard and tailored lengths including corner configurations Finishes: white, black, silver and custom
Integration	Trimless installation for 1/2"-5/8" drywall without disrupting the structure Bezel trim for hard surfaces such as drywall, wood and specialty ceilings and walls Grid trim for installation in grid ceiling systems
Distribution	Multiple lens for general, accent and decorative applications
LED	Constant Voltage, 90+ CRI, 3 Steps MacAdam 120 nominal lumens/watt average (see spec sheet for delivered lumens) Conformal coated for protection against humidity optional (-WL) Warm Dim to emulate incandescent when dimming; 75 nominal lumens per watt average RGBW for color changing applications; 50 nominal lumens per watt average L70 (TM21 Projected 85C) Static White = 60,000 hours RGBW = 50,000 hours, WD = 36,000 hours
Lens	OD - Opal Diffuser provides even, continuous line of light and general illumination MPL - Micro-prismatic lens provides lower brightness, general illumination BD - Block Diffuser of satin acrylic provides general illumination and decorative effect* *straight runs only, no corners
Driver	Compatible with quality constant voltage drivers
Weight	0.5lbs per foot
Operating Temp	Suitable for operation in maximum ambient temperature of 35C (95F)
Warranty	5-year Limited (see complete company warranty information)
Certifications	ETL and ETL-C for dry and damp location, CE
Voltages	24V Fixture / 120-277VAC Driver (remote)

Lenses/Accessories



Opal Diffuser (OD)
Micro-prismatic Lens (MPL)

Block Diffuser (BD)

Recessed Plaster Trim (RPT)

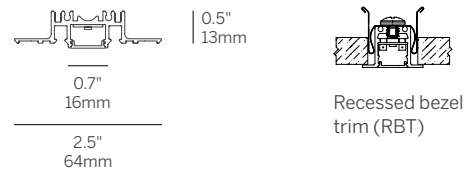
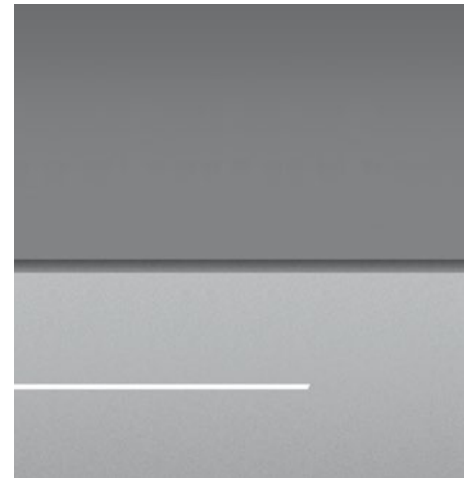

Recessed Grid Trim (RGT)

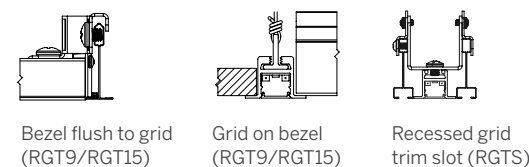
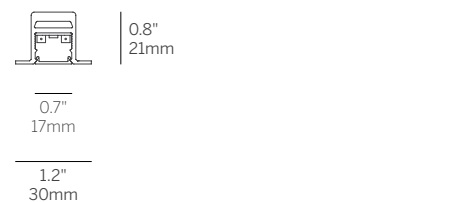
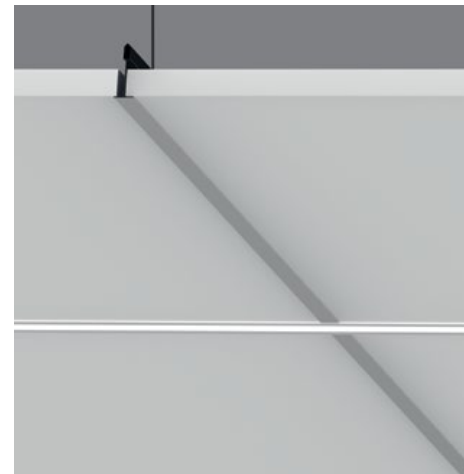

Bezel flush to grid
(RGT9/RGT15)

Grid on bezel
(RGT9/RGT15)

Recessed grid
trim slot (RGTS)

index

technical
information

20 Linear Recessed

Model	Fixation	Pattern	Length	Power ²	CRI/ CCT ³	Driver ⁴	Lens	Finish ⁶	Cable	Options
WG-20LDL	RPT RBT RGT9 RGT15 RGTS	S P ¹ PPI ¹ PPO ¹ PZ ¹	A A x B A x B x C A x B x A x B	L M H	927 930 935 940 WD RGBW	X S D010 DPH L3DAE L3DOE EL96 DMX	OD (std) MPL BDO ⁵ BDC ⁵	W (std) B S F	C4 (std) C10 C20 C30	CP EM WL ⁷

Model

- WG-20LDL = 20 Linear Downlight

Fixation

- RPT = Recessed plaster trim
- RBT = Recessed bezel trim
- RGT9 = Recessed grid trim 9/16"
- RGT15 = Recessed grid trim 15/16"
- RGTS = Recessed grid trim slot

Pattern

- S = Straight run
- P = Standard patterns 2, 3 or 4 sided with 90° corners on the same plane¹
- PPI = Wall to ceiling / wall to wall, 90° inside corner¹
- PPO = Wall to ceiling / wall to wall, 90° outside corner¹
- PZ = Non-standard patterns and/or corners other than 90° on multiple planes, consult factory¹

Length

- A, B, C = specify inches to the nearest 0.25" (i.e. 72.25")
For patterns specify each length (i.e. 2 sided: A x B = 72.25" x 48"; 3 sided: A x B x C; 4 sided: A x B x A x B)

Power²

- L = 3W/ft low power (WD 2.7 W/ft) (24V)
- M = 6W/ft mid power (WD 5.5 W/ft) (24V) (RGBW - 7.6 W/ft)
- H = 10W/ft high power (WD 8 W/ft) (24V)

CRI/CCT (90+ CRI)³

- 927 = 2700K
- 930 = 3000K
- 935 = 3500K
- 940 = 4000K
- WD = Warm Dimming 1800 - 3000K
- RGBW = 3000K White (M power only)

Driver (remote)⁴

- X = No driver, ordered separately
- S = Standard, non-dim driver 120-277V
- D010 = Osram, 10%, 0-10V dimming, 120-277V
- DPH = Phase Dimming, 1% dimming, 120V only
- L3DAE = Lutron Hi-lume 1% EcoSystem, 120-277V
- L3DOE = Lutron Hi-lume Premier 0.1% EcoSystem, 120-277V
- EL96 = Osram / EldoLED, 24V, 0.1% 0-10V Dimming
- DMX = Osram / EldoLED, 24V, 0.1% DMX Dimming

Lens

- OD = Satin opal diffuser (standard)
- MPL = Micro-prismatic lens
- BDO = Block Diffuser Opal⁵
- BDC = Block Diffuser Clear⁵

Finish⁶

- W = White, 15% gloss, RAL 9010 / Tiger Drylac 009/10120 (standard)
- B = Black, 15% gloss, RAL 9005 / Tiger Drylac 044/90053
- S = Silver, 15% gloss, RAL 9006 / Tiger Drylac 049/90500
- F = Custom finished trim, specify RAL

Cable

- C4 = 4' tray cable (plenum rated) (standard)
- C10 = 10' tray cable (plenum rated)
- C20 = 20' tray cable (plenum rated)
- C30 = 30' tray cable (plenum rated)

Options

- CP = Chicago Plenum
- EM = Emergency (remote)
- WL = Wet Location Under Canopy / Cover⁷

Whitegoods reserves the right to change any information without prior notice.

Notes

- See pattern spec sheet.
- Wattage shown is for LED boards only, system wattage varies depending on driver selected.
- Refer to specsheet for delivered lumen data for all product configurations.
- Remote power supply required. See power supply page for details.
- Butt seam (lens) when in continuous run, straight runs only. BDO/BDC offered for RBT / RGT only.
- See Tiger Drylac color chart: inter-lux.com/tiger
- Wet Location option available for OD / MPL lenses and recessed / surface ceiling applications only.

20 Linear Surface

- The most versatile lighting tool to deliver general and accent illumination for any indoor application from a 0.7" wide luminaire.
- Mounts via invisible clip to any surface, toolless mounting to grid ceilings, magnetic and adjustable bracket mounting.
- Straight runs and complex configurations with factory corners in exact lengths as specified.
- Multiple distribution options.
- 90+ CRI, 3 Steps MacAdam delivering excellent color rendering.
- Choice of White, RGBW and Warm Dim to emulate incandescent.
- Identical LED technology used throughout all Whitegoods Linears, Coves and Perimeter products deliver consistent quality and performance throughout a project.
- Made in USA.
- 5-year warranty.

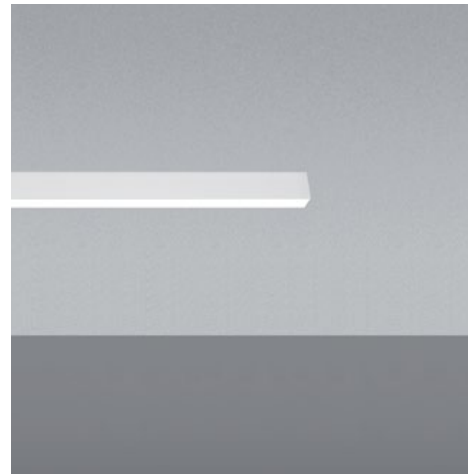

Housing	Precision extruded aluminum for true dimensions and tolerances Adjustable mounting bracket (90 and 180 degree) Standard and tailored lengths including corner configurations Finishes: white, black, silver and custom
Integration	Fixation onto any surface using standard clips, magnets and adjustable brackets
Distribution	Multiple lenses and louvers for general, accent, decorative and grazing applications
LED	Constant Voltage, 90+ CRI, 3 Steps MacAdam 120 nominal lumens/watt average (see spec sheet for delivered lumens) Conformal coated for protection against humidity optional (-WL) Warm Dim to emulate incandescent when dimming; 75 nominal lumens per watt average RGBW for color changing applications; 50 nominal lumens per watt average L70 (TM21 Projected 85C) Static White = 60,000 hours RGBW = 50,000 hours, WD = 36,000 hours
Lens	OD - Opal Diffuser provides even, continuous line of light and general illumination SD - Satin Clear Diffuser provides high efficiency soft edge beam, general illumination MPL - Micro-prismatic lens provides lower brightness, general illumination NL16 - Narrow Lens optic provides narrow beam for wall grazing applications* LL45 - 45 Degree Louver in white, black or satin provides extreme low brightness* BD - Block Diffuser of satin acrylic provides general illumination and decorative effect* ROD - Round Opal Diffuser 0.8" diameter provides general illumination* *straight runs only, no corners
Driver	Compatible with quality constant voltage drivers
Weight	0.5lbs per foot
Operating Temp	Suitable for operation in maximum ambient temperature of 35C (95F)
Warranty	5-year Limited (see complete company warranty information)
Certifications	ETL and ETL-C for dry and damp location, CE
Voltages	24V Fixture / 120-277VAC Driver (remote)

Lenses/Accessories



Surface Mount (SM)

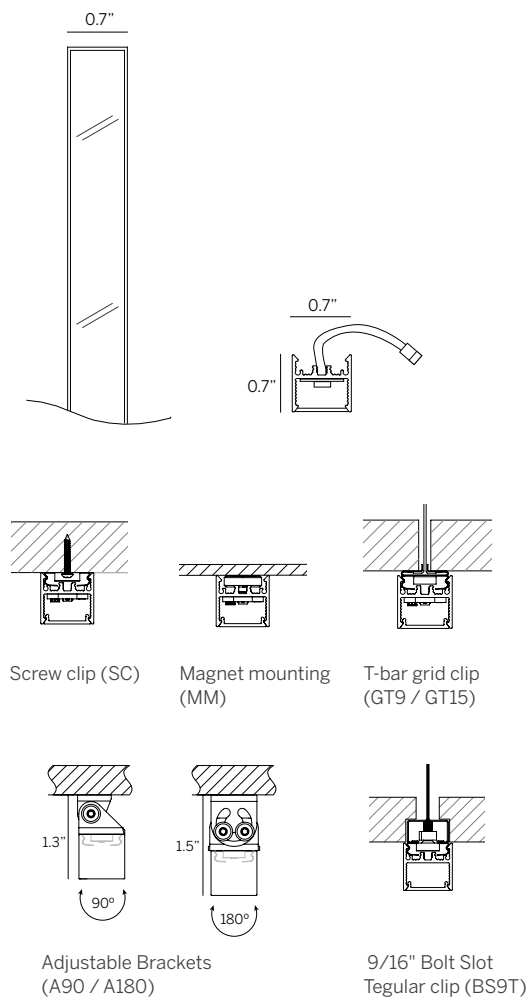

20 Linear Surface

Model	Fixation	Pattern	Length	Power ²	CRI/ CCT ³	Driver ⁴	Lens	Finish ⁷	Cable	Options
WG-20LDL-SM	SC MM GT9 GT15 BS9T A90 A180	S P ¹ PPI ¹ PPO ¹ PZ ¹	A A x B A x B x C A x B x A x B	L M H	927 930 935 940 WD RGBW	X S D010 DPH L3DAE L3DOE EL96 DMX	OD (std) SD MPL NL16 LL45B ⁵ LL45W ⁵ LL45S ⁵ BDO ⁶ BDC ⁶ ROD ⁶	W (std) B S F	C4 (std) C10 C20 C30	EM WL ⁸

Model

- WG-20LDL-SM = 20 Linear Surface

Fixation

- SC = Screw clip
- MM = Magnet mounting
- GT9 = 9/16" T-bar grid clip
- GT15 = 15/16" T-bar grid clip
- BS9T = 9/16" Bolt Slot Tegular clip (1/4" reveal)
- A90 = Adjustable 90° bracket
- A180 = Adjustable 180° bracket

Pattern

- S = Straight run
- P = Standard patterns 2, 3 or 4 sided with 90° corners on the same plane¹
- PPI = Pattern, Plane to Plane, Inside. 2-3-4 sided pattern with inside corners¹
- PPO = Pattern, Plane to Plane, Outside. 2-3-4 sided pattern with outside corners¹
- PZ = Non-standard patterns and/or corners other than 90° on multiple planes, consult factory¹

Length

- A, B, C = specify inches to the nearest 0.25" (i.e. 72"). For patterns specify each length (i.e. 2 sided: A x B = 72" x 48"; 3 sided: A x B x C; 4 sided: A x B x A x B).

Power²

- L = 3W/ft low power (WD 2.7 W/ft) (24V)
- M = 6W/ft mid power (WD 5.5 W/ft) (24V) (RGBW - 7.6 W/ft)
- H = 10W/ft high power (WD 8 W/ft) (24V)

CRI/CCT (90+ CRI)³

- 927 = 2700K
- 930 = 3000K
- 935 = 3500K
- 940 = 4000K
- WD = Warm Dimming 1800 - 3000K
- RGBW = 3000K White (M power only)

Driver (remote)⁴

- X = No driver, ordered separately
- S = Standard, non-dim driver 120-277V
- D010 = Osram, 10%, 0-10V dimming, 120-277V
- DPH = Phase Dimming, 1% dimming, 120V only
- L3DAE = Lutron Hi-lume 1% EcoSystem, 120-277V
- L3DOE = Lutron Hi-lume Premier 0.1% EcoSystem, 120-277V
- EL96 = Osram / EldoLED, 24V, 0.1% 0-10V Dimming
- DMX = Osram / EldoLED, 24V, 0.1% DMX Dimming

Lens

- OD = Satin opal diffuser (standard)
- SD = Satin clear diffuser
- MPL = Micro-prismatic lens
- NL16 = Linear narrow lens, 16°
- LL45B = Linear louver black⁵
- LL45W = Linear louver white⁵
- LL45S = Linear louver satin⁵
- BDO = Block Diffuser Opal⁶
- BDC = Block Diffuser Clear⁶
- ROD = Round opal diffuser⁶

Finish⁷

- W = White, 15% gloss, RAL 9010 / Tiger Drylac 009/10120 (standard)
- B = Black, 15% gloss, RAL 9005 / Tiger Drylac 044/90053
- S = Silver, 15% gloss, RAL 9006 / Tiger Drylac 049/90500
- F = Custom finished trim, specify RAL

Cable

- C4 = 4' tray cable (plenum rated) (standard)
- C10 = 10' tray cable (plenum rated)
- C20 = 20' tray cable (plenum rated)
- C30 = 30' tray cable (plenum rated)

Options

- EM = Emergency (remote)
- WL = Wet Location Under Canopy / Cover⁸

Whitegoods reserves the right to change any information without prior notice.

Notes

- 1 See pattern spec sheet.
- 2 Wattage shown is for LED boards only, system wattage varies depending on driver selected.
- 3 Refer to specs sheet for delivered lumen data for all product configurations.
- 4 Remote power supply required. See power supply page for details.
- 5 Louver available in 4.75" increments, straight runs only.
- 6 Butt seam (lens) when in continuous run, straight runs only.
- 7 See Tiger Drylac color chart: inter-lux.com/tiger
- 8 Wet Location option available for OD / SD / MPL lenses and recessed / surface ceiling applications only.

20 Linear Suspended

- Miniature suspended downlight for general, accent and decorative lighting.
- Power suspensions with small ceiling canopies.
- Multiple distribution options.
- 90+ CRI, 3 Steps MacAdam delivering excellent color rendering.
- Choice of White, RGBW and Warm Dim to emulate incandescent.
- Identical LED technology used throughout all Whitegoods Linears, Coves and Perimeter products deliver consistent quality and performance throughout a project.
- Made in USA.
- 5-year warranty.



Suspended (S)

Housing Precision extruded aluminum for true dimensions and tolerances
Lengths from 12"-72" single luminaires
Finishes: white, black, silver and custom

Integration Suspension from any surface

Distribution Multiple lenses and louvers for general, accent, decorative and grazing application

LED Constant Voltage, 90+ CRI, 3 Steps MacAdam
120 nominal lumens/watt average (see spec sheet for delivered lumens)
Warm Dim to emulate incandescent when dimming; 75 nominal lumens per watt average
RGBW for color changing applications; 50 nominal lumens per watt average
L70 (TM21 Projected 85C) Static White = 60,000 hours
RGBW = 50,000 hours, WD = 36,000 hours

Lens OD - Opal Diffuser provides even, continuous line of light and general illumination
MPL - Micro-prismatic lens provides lower brightness, general illumination
NL16 - Narrow Lens optic provides narrow beam for wall grazing applications
LL45 - 45 Degree Louver in white, black or satin provides extreme low brightness
BD - Block Diffuser of satin acrylic provides general illumination and decorative effect
ROD - Round Opal Diffuser 0.8" diameter provides general illumination

Driver Compatible with quality constant voltage drivers

Weight 0.5lbs per foot

Operating Temp Suitable for operation in maximum ambient temperature of 35C (95F)

Warranty 5-year Limited (see complete company warranty information)

Certifications ETL and ETL-C for dry and damp location, CE

Voltages 24V Fixture / 120-277VAC Driver (remote)

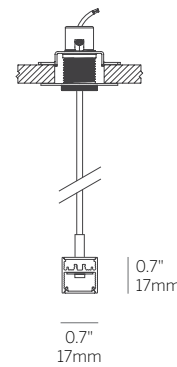

Gypsum /Tile Ceiling

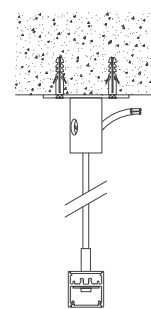

Solid Ceiling

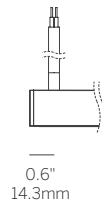

Power Feed

Lenses/Accessories

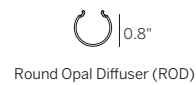
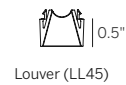
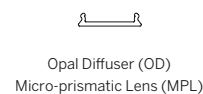

20 Linear Suspended

Model	Fixation	Pattern	Length	Power ¹	CRI/ CCT ²	Driver ³	Lens	Finish ⁶	Options
WG-20LDL	S48 (std) S96	S	A	L M H	927 930 935 940 WD RGBW	X S D010 DPH L3DAE L3DOE EL96 DMX	OD (std) MPL NL16 LL45B ⁴ LL45W ⁴ LL45S ⁴ BDO ⁵ BDC ⁵ ROD ⁵	W (std) B S F	EM

Model

- WG-20LDL-S = 20 Linear Suspended

Fixation

- S48 = 48" suspension cable standard, field-cuttable (standard)
- S96 = 96" suspension cable, field-cuttable (above 60" additional suspension added)

Pattern

- S = Straight run (individual fixtures only, for other configurations see WG-20LDI)

Length

- A = specify inches to the nearest 0.25" (i.e. 71.75") (72" max length)

Power¹

- L = 3W/ft low power (WD 2.7 W/ft) (24V)
- M = 6W/ft mid power (WD 5.5 W/ft) (24V) (RGBW - 7.6 W/ft)
- H = 10W/ft high power (WD 8 W/ft) (24V)

CRI/CCT (90+ CRI)²

- 927 = 2700K
- 930 = 3000K
- 935 = 3500K
- 940 = 4000K
- WD = Warm Dimming 1800 - 3000K
- RGBW = 3000K White (M power only)

Driver (remote)³

- X = No driver, ordered separately
- S = Standard, non-dim driver 120-277V
- D010 = Osram, 10%, 0-10V dimming, 120-277V
- DPH = Phase Dimming, 1% dimming, 120V only
- L3DAE = Lutron Hi-lume 1% EcoSystem, 120-277V
- L3DOE = Lutron Hi-lume Premier 0.1% EcoSystem, 120-277V
- EL96 = Osram / EldoLED, 24V, 0.1% 0-10V Dimming
- DMX = Osram / EldoLED, 24V, 0.1% DMX Dimming

Lens

- OD = Satin opal diffuser (standard)
- MPL = Micro-prismatic lens
- NL16 = Linear narrow lens, 16°
- LL45B = Linear louver black⁴
- LL45W = Linear louver white⁴
- LL45S = Linear louver satin⁴
- BDO = Block Diffuser Opal⁵
- BDC = Block Diffuser Clear⁵
- ROD = Round opal diffuser⁵

Finish⁶

- W = White, 15% gloss, RAL 9010 / Tiger Drylac 009/10120 (standard)
- B = Black, 15% gloss, RAL 9005 / Tiger Drylac 044/90053
- S = Silver, 15% gloss, RAL 9006 / Tiger Drylac 049/90500
- F = Custom finished trim, specify RAL

Options

- EM = Emergency (remote)

Whitegoods reserves the right to change any information without prior notice.

Notes

- 1 Wattage shown is for LED boards only, system wattage varies depending on driver selected.
- 2 Refer to specsheet for delivered lumen data for all product configurations.
- 3 Remote power supply required. See power supply page for details.
- 4 Louver available in 4.75" increments, straight runs only.
- 5 Butt seam (lens) when in continuous run, straight runs only.
- 6 See Tiger Drylac color chart: inter-lux.com/tiger

20 Linear Direct/Indirect Suspended

- Miniature suspended Direct, Indirect or Direct / Indirect for general, accent and decorative lighting.
- Power suspensions with small ceiling canopies and continuous rows.
- Rectangular and multi-sided configurations with factory corners.
- Multiple distribution options.
- 90+ CRI, 3 Steps MacAdam delivering excellent color rendering.
- Choice of White, RGBW and Warm Dim to emulate incandescent.
- Identical LED technology used throughout all Whitegoods Linears, Coves and Perimeter products deliver consistent quality and performance throughout a project.
- Made in USA.
- 5-year warranty.



Suspended (S)

Housing Precision extruded aluminum for true dimensions and tolerances
Standard and tailored lengths including corner configurations
Finishes: white, black, silver and custom

Integration Suspension from any surface

Distribution Multiple lenses and louvers for general, accent, decorative and grazing application

LED Constant Voltage, 90+ CRI, 3 Steps MacAdam
120 nominal lumens/watt average (see spec sheet for delivered lumens)
Warm Dim to emulate incandescent when dimming; 75 nominal lumens per watt average
RGBW for color changing applications; 50 nominal lumens per watt average
L70 (TM21 Projected 85C) Static White = 60,000 hours
RGBW = 50,000 hours, WD = 36,000 hours

Lens OD - Opal Diffuser provides even, continuous line of light and general illumination
SD - Satin Clear Diffuser provides high efficiency soft edge beam, general illumination
MPL - Micro-prismatic lens provides lower brightness, general illumination
NL16 - Narrow Lens optic provides narrow beam for wall grazing applications*
LL45 - 45 Degree Louver in white, black or satin provides extreme low brightness*
BD - Block Diffuser of satin acrylic provides general illumination and decorative effect*
ROD - Round Opal Diffuser 0.8" diameter provides general illumination*
*Straight runs only – no corners

Driver Compatible with quality constant voltage drivers

Weight 0.5lbs per foot

Operating Temp Suitable for operation in maximum ambient temperature of 35C (95F)

Warranty 5-year Limited (see complete company warranty information)

Certifications ETL and ETL-C for dry and damp location, CE

Voltages 24V Fixture / 120-277VAC Driver (remote)

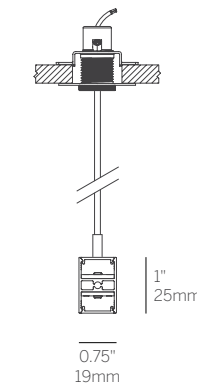

Gypsum / Tile Ceiling

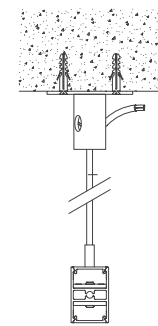

Solid Ceiling

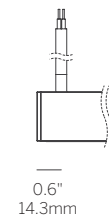

Power Feed

Lenses/Accessories



20 Linear Direct/Indirect Suspended

Model	Fixation	Pattern	Length	Direct				Indirect				Finish ⁷	Options
				Power ²	CRI/ CCT ³	Driver ⁴	Lens	Power ²	CRI/ CCT ³	Driver ⁴	Lens		
WG-20LDI direct / indirect	S48 (std) S96	S P ¹	A A x B	L M	927 930	X S	OD (std) MPL	L M	927 930	X S	OD (std) SD	W (std) B	5C DC
WG-20LD direct		PZ ¹	A x B x C A x B x A x B	H	935 940 WD RGBW	D010 DPH L3DAE L3DOE EL96 DMX	NL16 LL45B ⁵ LL45W ⁵ LL45S ⁵ BDO ⁶ BDC ⁶ ROD ⁶	H	935 940 WD RGBW	D010 L3DAE L3DOE EL96 DMX	S F	EM	
WG-20LI indirect													

Model

- WG-20LDI = 20 Linear Direct/Indirect Suspended
- WG-20LD = 20 Linear Direct Suspended
- WG-20LI = 20 Linear Indirect Suspended

Fixation

- S48 = 48" suspension cable standard, field-cuttable (standard)
- S96 = 96" suspension cable, field-cuttable

Pattern

- S = Straight run (continuous runs of any length available in 0.25" increments) (above 60" additional suspension points)
- P = Standard patterns 2, 3 or 4 sided with 90° corners on the same plane¹
- PZ = Non-standard patterns and/or corners other than 90° on multiple planes, consult factory¹

Length

- A, B, C = specify inches to the nearest 0.25" (i.e. 72.25")
For patterns specify each length (i.e. 2 sided: A x B = 72.25" x 48"; 3 sided: A x B x C; 4 sided: A x B x A x B)

Power²

- L = 3W/ft low power (WD 2.7 W/ft) (24V)
- M = 6W/ft mid power (WD 5.5 W/ft) (24V) (RGBW - 7.6 W/ft)
- H = 10W/ft high power (WD 8 W/ft) (24V)

CRI/CCT (90+ CRI)³

- 927 = 2700K
- 930 = 3000K
- 935 = 3500K
- 940 = 4000K
- WD = Warm Dimming 1800 - 3000K
- RGBW = 3000K White (M power only)

Driver (remote)⁴

- X = No driver, ordered separately
- S = Standard, non-dim driver 120-277V
- D010 = Osram, 10%, 0-10V dimming, 120-277V
- DPH = Phase Dimming, 1% dimming, 120V only
- L3DAE = Lutron Hi-lume 1% EcoSystem, 120-277V
- L3DOE = Lutron Hi-lume Premier 0.1% EcoSystem, 120-277V
- EL96 = Osram / EldoLED, 24V, 0.1% 0-10V Dimming
- DMX = Osram / EldoLED, 24V, 0.1% DMX Dimming

Lens

- OD = Satin opal diffuser (standard)
- SD = Satin clear diffuser
- MPL = Micro-prismatic lens
- NL16 = Linear narrow lens, 16°
- LL45B = Linear louver black⁵
- LL45W = Linear louver white⁵
- LL45S = Linear louver satin⁵
- BDO = Block Diffuser Opal⁶
- BDC = Block Diffuser Clear⁶
- ROD = Round opal diffuser⁶

Finish⁷

- W = White, 15% gloss, RAL 9010 / Tiger Drylac 009/10120 (standard)
- B = Black, 15% gloss, RAL 9005 / Tiger Drylac 044/90053
- S = Silver, 15% gloss, RAL 9006 / Tiger Drylac 049/90500
- F = Custom finished trim, specify RAL

Options

- 5C = 5" canopy (use with 4" Jbox)
- DC = Dual circuit
- EM = Emergency (remote)

Whitegoods reserves the right to change any information without prior notice.

Notes

- See pattern spec sheet.
- Wattage is shown for LED boards only, system wattage varies depending on driver selected. Maximum combined wattage for Direct + Indirect shall not exceed 13 W/ft.
- When specifying 20LDI please specify CRI / CCT and Driver for Direct and Indirect if different CRI / CCT / Driver is needed, i.e. 930-M-OD-D010-RGBW-M-SD-DMX. Refer to specsheet for delivered lumen data for all product configurations.
- Remote power supply required. See power supply page for details.
- Louver available in 4.75" increments, straight runs only.
- Butt seam (lens) when in continuous run, straight runs only.
- See Tiger Drylac color chart: inter-lux.com/tiger

20 Linear Direct/Indirect Surface Wall

- Miniature wall-mounted Direct, Indirect or Direct / Indirect for perimeter lighting.
- Available in continuous, straight runs.
- Multiple distribution options.
- 90+ CRI, 3 Steps MacAdam delivering excellent color rendering.
- Choice of White, RGBW and Warm Dim to emulate incandescent.
- Identical LED technology used throughout all Whitegoods Linears, Coves and Perimeter products deliver consistent quality and performance throughout a project.
- Made in USA.
- 5-year warranty.



Surface Wall Mount (SW)

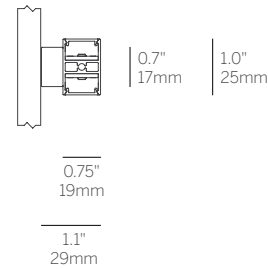

Housing	Precision extruded aluminum for true dimensions and tolerances Nominal 1" high x 1" extension from the wall Finishes: white, black, silver and custom
Integration	Wall mount without visible hardware
Distribution	Multiple lenses and louvers for general perimeter, decorative and grazing application
LED	Constant Voltage, 90+ CRI, 3 Steps MacAdam 120 nominal lumens/watt average (see spec sheet for delivered lumens) Warm Dim to emulate incandescent when dimming; 75 nominal lumens per watt average RGBW for color changing applications; 50 nominal lumens per watt average L70 (TM21 Projected 85C) Static White = 60,000 hours RGBW = 50,000 hours, WD = 36,000 hours
Lens	OD - Opal Diffuser provides even, continuous line of light and general illumination SD - Satin Clear Diffuser provides high efficiency soft edge beam, general illumination MPL - Micro-prismatic lens provides lower brightness, general illumination NL16 - Narrow Lens optic provides narrow beam for wall grazing applications* LL45 - 45 Degree Louver in white, black or satin provides extreme low brightness* *Straight runs only – no corners
Driver	Compatible with quality constant current drivers
Weight	0.5lbs per foot
Operating Temp	Suitable for operation in maximum ambient temperature of 35C (95F)
Warranty	5-year Limited (see complete company warranty information)
Certifications	ETL and ETL-C for dry and damp location, CE
Voltages	24V Fixture / 120-277VAC Driver (remote)

Lenses/Accessories



20 Linear Direct/Indirect Surface Wall

Model	Fixation	Pattern	Length	Direct				Indirect				Finish ⁶	Options
				Power ²	CRI/CCT ³	Driver ⁴	Lens	Power ²	CRI/CCT ³	Driver ⁴	Lens		
WG-20LDI direct/indirect	SW	S PI ¹ PO ¹	A A x B A x B x C A x B x A x B	L	927	X	OD (std)	L	927	X	OD (std)	W (std) B S F	DC EM
WG-20LD direct				M	930	S	MPL	M	930	S	SD		
WG-20LI indirect				H	935	D010	NL16	H	935	D010	NL16		
					940	DPH	LL45B ⁵		940	DPH	LL45B ⁵		
					WD	L3DAE	LL45W ⁵		WD	L3DAE	LL45W ⁵		
					RGBW	L3DOE	LL45S ⁵		RGBW	L3DOE	LL45S ⁵		
						EL96				EL96			
						DMX				DMX			

Model

- WG-20LDI = 20 Linear Direct/Indirect Surface Wall Mount
- WG-20LD = 20 Linear Direct Surface Wall Mount
- WG-20LI = 20 Linear Indirect Surface Wall Mount

Fixation

- SW = Surface wall mount

Pattern

- S = Straight run
- PI = Standard patterns 2, 3 or 4 sided with 90° inside corners on the same plane¹
- PO = Standard patterns 2, 3 or 4 sided with 90° outside corners on the same plane¹

Length

- A, B, C = specify inches to the nearest 0.25" (i.e. 72.25")
For patterns specify each length (i.e. 2 sided: A x B = 72.25" x 48"; 3 sided: A x B x C; 4 sided: A x B x A x B)

Power²

- L = 3W/ft low power (WD 2.7 W/ft) (24V)
- M = 6W/ft mid power (WD 5.5 W/ft) (24V) (RGBW - 7.6 W/ft)
- H = 10W/ft high power (WD 8 W/ft) (24V)

CRI/CCT (90+ CRI)³

- 927 = 2700K
- 930 = 3000K
- 935 = 3500K
- 940 = 4000K
- WD = Warm Dimming 1800 - 3000K
- RGBW = 3000K White (M power only)

Driver (remote)⁴

- X = No driver, ordered separately
- S = Standard, non-dim driver 120-277V
- D010 = Osram, 10%, 0-10V dimming, 120-277V
- DPH = Phase Dimming, 1% dimming, 120V only
- L3DAE = Lutron Hi-lume 1% EcoSystem, 120-277V
- L3DOE = Lutron Hi-lume Premier 0.1% EcoSystem, 120-277V
- EL96 = Osram / EldoLED, 24V, 0.1% 0-10V Dimming
- DMX = Osram / EldoLED, 24V, 0.1% DMX Dimming

Lens

- OD = Satin opal diffuser (standard)
- SD = Satin clear diffuser
- MPL = Micro-prismatic lens
- NL16 = Linear narrow lens, 16°
- LL45B = Linear louver black⁵
- LL45W = Linear louver white⁵
- LL45S = Linear louver satin⁵

Finish⁶

- W = White, 15% gloss, RAL 9010 / Tiger Drylac 009/10120 (standard)
- B = Black, 15% gloss, RAL 9005 / Tiger Drylac 044/90053
- S = Silver, 15% gloss, RAL 9006 / Tiger Drylac 049/90500
- F = Custom finished trim, specify RAL

Options

- DC = Dual circuit
- EM = Emergency (remote)

Whitegoods reserves the right to change any information without prior notice.

Notes



- 1 See pattern spec sheet.
- 2 Wattage is shown for LED boards only, system wattage varies depending on driver selected. Maximum combined wattage for Direct + Indirect shall not exceed 13 W/ft.
- 3 When specifying 20LDI please specify CRI / CCT and Driver for Direct and Indirect if different CRI / CCT / Driver is needed, i.e. 930-M-OD-D010-RGBW-M-SD-DMX. Refer to specsheet for delivered lumen data for all product configurations.
- 4 Remote power supply required. See power supply page for details.
- 5 Louver available in 4.75" increments, straight runs only.
- 6 See Tiger Drylac color chart: inter-lux.com/tiger

20 Linear Wash Light Recessed

- Fully recessed Wash Light for even illumination of walls, ceilings and floors.
- Minimal aperture of 0.7" of continuous and even illumination.
- Trimless and bezel trim for seamless integration into any drywall, wood and metal surfaces.
- Trimless installation into drywall without disturbing the ceiling structure.
- Straight runs and configurations with factory corners in exact lengths as specified.
- 90+ CRI, 3 Steps MacAdam delivering excellent color rendering.
- Choice of White, RGBW and Warm Dim to emulate incandescent.
- Identical LED technology used throughout all Whitegoods Linears, Coves and Perimeter products deliver consistent quality and performance throughout a project.
- Made in USA.
- 5-year warranty.

Housing	Precision extruded aluminum for true dimensions and tolerances All low voltage connections are made in the housing Luminaire snaps into the housing without tools Finishes: white, black, silver and custom
Integration	Fixation into gypsum, hard ceilings and all grid ceiling types
Distribution	Even wash of light
LED	Constant Voltage, 90+ CRI, 3 Steps MacAdam 120 nominal lumens/watt average (see spec sheet for delivered lumens) Conformal coated for protection against humidity optional (-WL) Warm Dim to emulate incandescent when dimming; 75 nominal lumens per watt average RGBW for color changing applications; 50 nominal lumens per watt average L70 (TM21 Projected 85C) Static White = 60,000 hours RGBW = 50,000 hours, WD = 36,000 hours
Lens	OD - Opal Diffuser provides even, continuous line of light and general illumination SD - Satin Clear Diffuser provides high efficiency soft edge beam, general illumination MPL - Micro-prismatic lens provides lower brightness, general illumination
Driver	Compatible with quality constant voltage drivers
Weight	1lbs per foot
Operating Temp	Suitable for operation in maximum ambient temperature of 35C (95F)
Warranty	5-year Limited (see complete company warranty information)
Certifications	ETL and ETL-C for dry and damp location, CE
Voltages	24V Fixture / 120-277VAC Driver (remote)

Lenses/Accessories

-  Opal Diffuser (OD)
-  Satin Diffuser (SD)
-  Micro-prismatic Lens (MPL)

Recessed Plaster Trim (RPT)

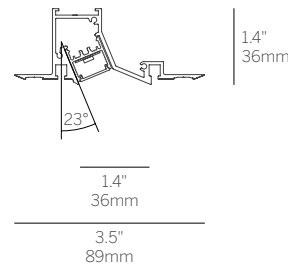
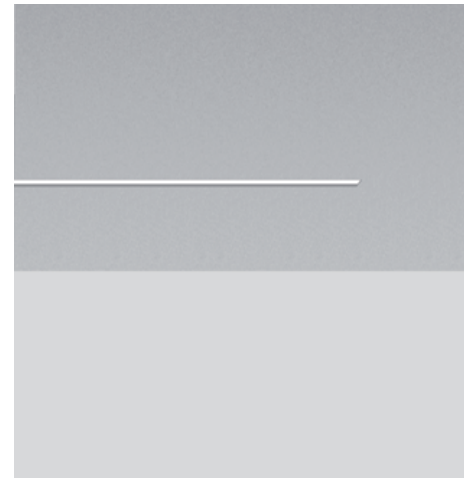

Recessed Bezel Trim (RBT)

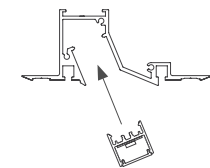
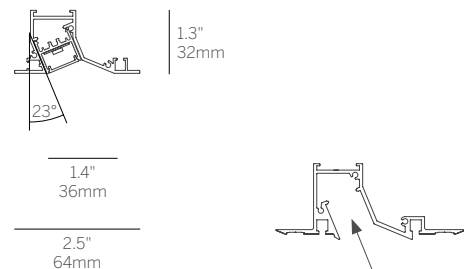
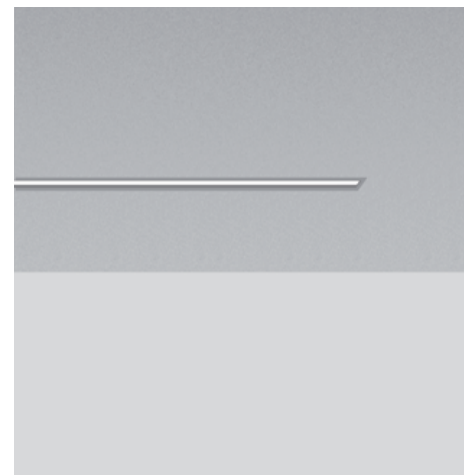

index

technical information

20 Linear Wash Light Recessed

Model	Fixation	Pattern	Length	Power ²	CRI/CCT ³	Driver ⁴	Lens	Finish ⁵	Options
WG-20LWW	RPT RBT RGT9 RGT15	S PI ¹ PO ¹ PZ ¹	A A x B A x B x C A x B x A x B	L M H	927 930 935 940 WD RGBW	X S D010 DPH L3DAE L3DOE EL96 DMX	OD (std) SD MPL	W (std) B S F	EM WL ⁶

Model

- WG-20LWW = 20 Linear Wash Light Recessed

Fixation

- RPT = Recessed plaster trim
- RBT = Recessed bezel trim
- RGT9 = Recessed grid trim 9/16"
- RGT15 = Recessed grid trim 15/16"

Pattern

- S = Straight run
- PI = Standard patterns 2, 3 or 4 sided with 90° inside corners on the same plane¹
- PO = Standard patterns 2, 3 or 4 sided with 90° outside corners on the same plane¹
- PZ = Non-standard patterns and/or corners other than 90° on multiple planes, consult factory¹

Length

- A, B, C = specify inches to the nearest 0.25" (i.e. 72.25")
For patterns specify each length (i.e. 2 sided: A x B = 72.25" x 48"; 3 sided: A x B x C; 4 sided: A x B x A x B)
- For 2 and 4 foot fixtures to fit ceiling grids specify 24" and 48" lengths

Power²

- L = 3W/ft low power (WD 2.7 W/ft) (24V)
- M = 6W/ft mid power (WD 5.5 W/ft) (24V) (RGBW - 7.6 W/ft)
- H = 10W/ft high power (WD 8 W/ft) (24V)

CRI/CCT (90+ CRI)³

- 927 = 2700K
- 930 = 3000K
- 935 = 3500K
- 940 = 4000K
- WD = Warm Dimming 1800 - 3000K
- RGBW = 3000K White (M power only)

Driver (remote)⁴

- X = No driver, ordered separately
- S = Standard, non-dim driver 120-277V
- D010 = Osram, 10%, 0-10V dimming, 120-277V
- DPH = Phase Dimming, 1% dimming, 120V only
- L3DAE = Lutron Hi-lume 1% EcoSystem, 120-277V
- L3DOE = Lutron Hi-lume Premier 0.1% EcoSystem, 120-277V
- EL96 = Osram / EldoLED, 24V, 0.1% 0-10V Dimming
- DMX = Osram / EldoLED, 24V, 0.1% DMX Dimming

Lens

- OD = Satin opal diffuser (standard)
- SD = Satin clear diffuser
- MPL = Micro-prismatic lens

Finish⁵

- W = White, 15% gloss, RAL 9010 / Tiger Drylac 009/10120 (standard)
- B = Black, 15% gloss, RAL 9005 / Tiger Drylac 044/90053
- S = Silver, 15% gloss, RAL 9006 / Tiger Drylac 049/90500
- F = Custom finished trim, specify RAL

Options

- EM = Emergency (remote)
- WL = Wet Location Under Canopy / Cover⁶

Whitegoods reserves the right to change any information without prior notice.

Notes

- See pattern spec sheet
- Wattage shown is for LED boards only, system wattage varies depending on driver selected.
- Refer to specsheet for delivered lumen data for all product configurations.
- Remote power supply required. See power supply page for details.
- See Tiger Drylac color chart: inter-lux.com/tiger
- Wet Location option available for OD / SD / MPL lenses and recessed / surface ceiling applications only.

20 Linear Wash Light Surface

- Miniature Surface Mount Wash Light for even illumination of walls, ceilings and floors.
- Mounts via invisible clip to any surface or toolless mounting to grid ceilings
- Straight runs and configurations with factory corners in exact lengths as specified.
- 90+ CRI, 3 Steps MacAdam delivering excellent color rendering.
- Choice of White, RGBW and Warm Dim to emulate incandescent.
- Identical LED technology used throughout all Whitegoods Linears, Coves and Perimeter products deliver consistent quality and performance throughout a project.
- Made in USA.
- 5-year warranty.



Surface Mount (SM)

Housing	Precision extruded aluminum for true dimensions and tolerances All low voltage connections are made in the housing Luminaire snaps into the housing without tools Finishes: white, black, silver and custom
Integration	Fixation onto any surface using standard clips
Distribution	Even wash of light
LED	Constant Voltage, 90+ CRI, 3 Steps MacAdam 120 nominal lumens/watt average (see spec sheet for delivered lumens) Conformal coated for protection against humidity optional (-WL) Warm Dim to emulate incandescent when dimming; 75 nominal lumens per watt average RGBW for color changing applications; 50 nominal lumens per watt average L70 (TM21 Projected 85C) Static White = 60,000 hours RGBW = 50,000 hours, WD = 36,000 hours
Lens	OD - Opal Diffuser provides even, continuous line of light and general illumination SD - Satin Clear Diffuser provides high efficiency soft edge beam, general illumination MPL - Micro-prismatic lens provides lower brightness, general illumination
Driver	Compatible with quality constant voltage drivers
Weight	1lbs per foot
Operating Temp	Suitable for operation in maximum ambient temperature of 35C (95F)
Warranty	5-year Limited (see complete company warranty information)
Certifications	ETL and ETL-C for dry and damp location, CE
Voltages	24V Fixture / 120-277VAC Driver (remote)

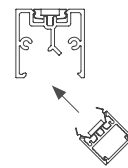
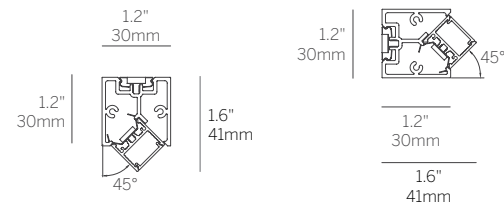

Lenses/Accessories



Opal Diffuser (OD)
Satin Diffuser (SD)
Micro-prismatic Lens (MPL)

index

technical
information

20 Linear Wash Light Surface

Model	Fixation	Pattern	Length	Power ²	CRI/ CCT ³	Driver ⁴	Lens	Finish ⁵	Options
WG-20LWW-SM	SC GT9 GT15	S PI ¹ PO ¹ PZ ¹	A A x B A x B x C A x B x A x B	L M H	927 930 935 940 WD RGBW	X S D010 DPH L3DAE L3DOE EL96 DMX	OD (std) SD MPL	W (std) B S F	EM WL ⁶

Model

- WG-20LWW-SM = 20 Linear Wash Light Surface

Fixation

- SC = Screw clip
- GT9 = 9/16" T-bar grid clip
- GT15 = 15/16" T-bar grid clip

Pattern

- S = Straight run
- PI = Standard patterns 2, 3 or 4 sided with 90° inside corners on the same plane¹
- PO = Standard patterns 2, 3 or 4 sided with 90° outside corners on the same plane¹
- PZ = Non-standard patterns and/or corners other than 90° on multiple planes, consult factory¹

Length

- A, B, C = specify inches to the nearest 0.25" (i.e. 72.25")
For patterns specify each length (i.e. 2 sided: A x B = 72.25" x 48"; 3 sided: A x B x C; 4 sided: A x B x A x B)
- For 2 and 4 foot fixtures to fit ceiling grids specify 24" and 48" lengths

Power²

- L = 3W/ft low power (WD 2.7 W/ft) (24V)
- M = 6W/ft mid power (WD 5.5 W/ft) (24V) (RGBW - 7.6 W/ft)
- H = 10W/ft high power (WD 8 W/ft) (24V)

CRI/CCT (90+ CRI)³

- 927 = 2700K
- 930 = 3000K
- 935 = 3500K
- 940 = 4000K
- WD = Warm Dimming 1800 - 3000K
- RGBW = 3000K White (M power only)

Driver (remote)⁴

- X = No driver, ordered separately
- S = Standard, non-dim driver 120-277V
- D010 = Osram, 10%, 0-10V dimming, 120-277V
- DPH = Phase Dimming, 1% dimming, 120V only
- L3DAE = Lutron Hi-lume 1% EcoSystem, 120-277V
- L3DOE = Lutron Hi-lume Premier 0.1% EcoSystem, 120-277V
- EL96 = Osram / EldoLED, 24V, 0.1% 0-10V Dimming
- DMX = Osram / EldoLED, 24V, 0.1% DMX Dimming

Lens

- OD = Satin opal diffuser (standard)
- SD = Satin clear diffuser
- MPL = Micro-prismatic lens

Finish⁵

- W = White, 15% gloss, RAL 9010 / Tiger Drylac 009/10120 (standard)
- B = Black, 15% gloss, RAL 9005 / Tiger Drylac 044/90053
- S = Silver, 15% gloss, RAL 9006 / Tiger Drylac 049/90500
- F = Custom finished trim, specify RAL

Options

- EM = Emergency (remote)
- WL = Wet Location Under Canopy / Cover⁶

Whitegoods reserves the right to change any information without prior notice.

Notes

- 1 See pattern spec sheet.
- 2 Wattage shown is for LED boards only, system wattage varies depending on driver selected.
- 3 Refer to specsheet for delivered lumen data for all product configurations.
- 4 Remote power supply required. See power supply page for details.
- 5 See Tiger Drylac color chart: inter-lux.com/tiger
- 6 Wet Location option available for OD / SD / MPL lenses and recessed / surface ceiling applications only.

20 Linear Wash Light Suspended

- Miniature Suspended Wash Light for even illumination of walls.
- Mounts via power suspensions to any surface with a low voltage canopy.
- Straight runs in exact lengths as specified.
- 90+ CRI, 3 Steps MacAdam delivering excellent color rendering.
- Choice of White, RGBW and Warm Dim to emulate incandescent.
- Identical LED technology used throughout all Whitegoods Linears, Coves and Perimeter products deliver consistent quality and performance throughout a project.
- Made in USA.
- 5-year warranty.

Housing	Precision extruded aluminum for true dimensions and tolerances All low voltage connections are made in the housing Luminaire snaps into the housing without tools Finishes: white, black, silver and custom
Integration	Suspension from any surface
Distribution	Even wash of light
LED	Constant Voltage, 90+ CRI, 3 Steps MacAdam 120 nominal lumens/watt average (see spec sheet for delivered lumens) Warm Dim to emulate incandescent when dimming; 75 nominal lumens per watt average RGBW for color changing applications; 50 nominal lumens per watt average L70 (TM21 Projected 85C) Static White = 60,000 hours RGBW = 50,000 hours, WD = 36,000 hours
Lens	OD - Opal Diffuser provides even, continuous line of light and general illumination SD - Satin Clear Diffuser provides high efficiency soft edge beam, general illumination MPL - Micro-prismatic lens provides lower brightness, general illumination
Driver	Compatible with quality constant voltage drivers
Weight	1lbs per foot
Operating Temp	Suitable for operation in maximum ambient temperature of 35C (95F)
Warranty	5-year Limited (see complete company warranty information)
Certifications	ETL and ETL-C for dry and damp location, CE
Voltages	24V Fixture / 120-277VAC Driver (remote)

Lenses/Accessories

- Opal Diffuser (OD)
- Satin Diffuser (SD)
- Micro-prismatic Lens (MPL)



Suspended (S)

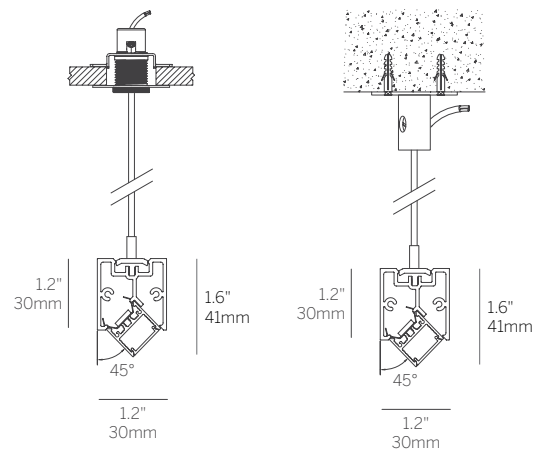

Gypsum Ceiling

Solid Ceiling

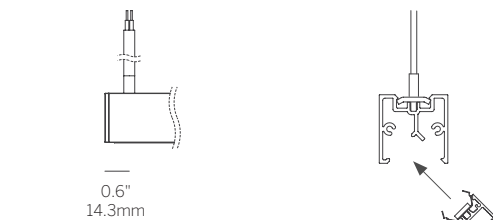

Power Feed

20 Linear Wash Light Suspended

Model	Fixation	Pattern	Length	Power ²	CRI/CCT ³	Driver ⁴	Lens	Finish ⁵	Options
WG-20LWW	S48 (std) S96	S PI ¹ PO ¹	A A x B A x B x C A x B x A x B	L M H	927 930 935 940	X S D010 DPH WD L3DAE L3DOE EL96 DMX	OD (std) SD MPL	W (std) B S F	EM

Model

- WG-20LWW = 20 Linear Wash Light Suspended

Fixation

- S48 = 48" suspension cable standard, field-cuttable (standard)
- S96 = 96" suspension cable, field-cuttable (above 60" additional suspension added)

Pattern

- S = Straight run
- PI = Standard patterns 2, 3 or 4 sided with 90° inside corners on the same plane¹
- PO = Standard patterns 2, 3 or 4 sided with 90° outside corners on the same plane¹

Length

- A, B, C = specify inches to the nearest 0.25" (i.e. 72.25")
For patterns specify each length (i.e. 2 sided: A x B = 72.25" x 48"; 3 sided: A x B x C; 4 sided: A x B x A x B)

Power²

- L = 3W/ft low power (WD 2.7 W/ft) (24V)
- M = 6W/ft mid power (WD 5.5 W/ft) (24V) (RGBW - 7.6 W/ft)
- H = 10W/ft high power (WD 8 W/ft) (24V)

CRI/CCT (90+ CRI)³

- 927 = 2700K
- 930 = 3000K
- 935 = 3500K
- 940 = 4000K
- WD = Warm Dimming 1800 - 3000K
- RGBW = 3000K White (M power only)

Driver (remote)⁴

- X = No driver, ordered separately
- S = Standard, non-dim driver 120-277V
- D010 = Osram, 10%, 0-10V dimming, 120-277V
- DPH = Phase Dimming, 1% dimming, 120V only
- L3DAE = Lutron Hi-lume 1% EcoSystem, 120-277V
- L3DOE = Lutron Hi-lume Premier 0.1% EcoSystem, 120-277V
- EL96 = Osram / EldoLED, 24V, 0.1% 0-10V Dimming
- DMX = Osram / EldoLED, 24V, 0.1% DMX Dimming

Lens

- OD = Satin opal diffuser (standard)
- SD = Satin clear diffuser
- MPL = Micro-prismatic lens

Finish⁵

- W = White, 15% gloss, RAL 9010 / Tiger Drylac 009/10120 (standard)
- B = Black, 15% gloss, RAL 9005 / Tiger Drylac 044/90053
- S = Silver, 15% gloss, RAL 9006 / Tiger Drylac 049/90500
- F = Custom finished trim, specify RAL

Options

- EM = Emergency (remote)

Whitegoods reserves the right to change any information without prior notice.

Notes

- 1 See pattern spec sheet.
- 2 Wattage shown is for LED boards only, system wattage varies depending on driver selected.
- 3 Refer to specsheet for delivered lumen data for all product configurations.
- 4 Remote power supply required. See power supply page for details.
- 5 See Tiger Drylac color chart: inter-lux.com/tiger

20 Linear Wash Light Semi-Recessed

- Semi-Recessed Wash Light for even illumination of walls, ceilings and floors.
- Trimless and bezel trim for seamless integration into any drywall, wood and metal surfaces.
- Trimless installation into drywall without disturbing the ceiling or wall structure.
- Straight runs in exact lengths as specified.
- 90+ CRI, 3 Steps MacAdam delivering excellent color rendering.
- Choice of White, RGBW and Warm Dim to emulate incandescent.
- Identical LED technology used throughout all Whitegoods Linears, Coves and Perimeter products deliver consistent quality and performance throughout a project.
- Made in USA.
- 5-year warranty.

Housing	Precision extruded aluminum for true dimensions and tolerances All low voltage connections are made in the housing Luminaire snaps into the housing without tools Finishes: white, black, silver and custom
Integration	Fixation into gypsum, hard ceilings and all grid ceiling types
Distribution	Even wash of light
LED	Constant Voltage, 90+ CRI, 3 Steps MacAdam 120 nominal lumens/watt average (see spec sheet for delivered lumens) Conformal coated for protection against humidity optional (-WL) Warm Dim to emulate incandescent when dimming; 75 nominal lumens per watt average RGBW for color changing applications; 50 nominal lumens per watt average L70 (TM21 Projected 85C) Static White = 60,000 hours RGBW = 50,000 hours, WD = 36,000 hours
Lens	OD - Opal Diffuser provides even, continuous line of light and general illumination SD - Satin Clear Diffuser provides high efficiency soft edge beam, general illumination MPL - Micro-prismatic lens provides lower brightness, general illumination
Driver	Compatible with quality constant voltage drivers
Weight	1lbs per foot
Operating Temp	Suitable for operation in maximum ambient temperature of 35C (95F)
Warranty	5-year Limited (see complete company warranty information)
Certifications	ETL and ETL-C for dry and damp location, CE
Voltages	24V Fixture / 120-277VAC Driver (remote)

Lenses/Accessories

- Opal Diffuser (OD)
- Satin Diffuser (SD)
- Micro-prismatic Lens (MPL)

Semi Recessed Plaster Trim (SRPT)

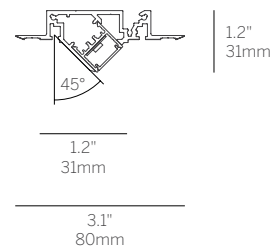

Semi Recessed Bezel Trim (SRBT)

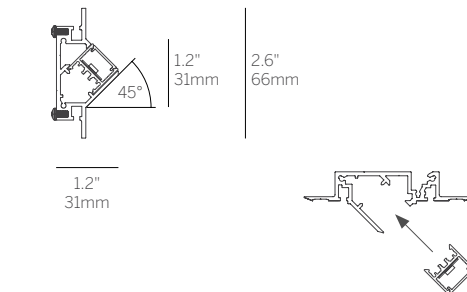
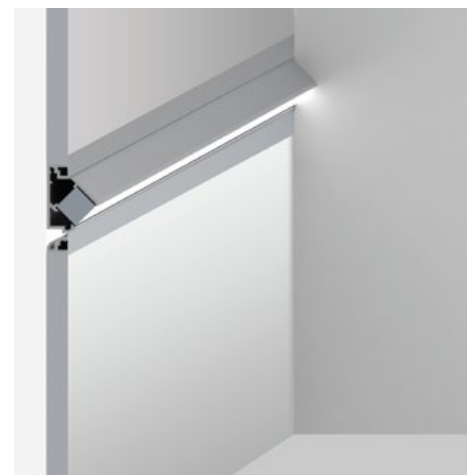

20 Linear Wash Light Semi-Recessed

Model	Fixation	Pattern	Length	Power ²	CRI/CCT ³	Driver ⁴	Lens	Finish ⁵	Options
WG-20LWW	SRPT SRBT SRGT9 SRGT15	S PI ¹ PO ¹ PZ ¹	A A x B A x B x C A x B x A x B	L M H	927 930 935 940 WD RGBW	X S D010 DPH L3DAE L3DOE EL96 DMX	OD (std) SD MPL	W (std) B S F	EM WL ⁶

Model

- WG-20LWW = 20 Linear Wash Light Semi Recessed

Fixation

- SRPT = Semi recessed plaster trim
- SRBT = Semi recessed bezel trim
- SRGT9 = Semi recessed grid trim 9/16"
- SRGT15 = Semi recessed grid trim 15/16"

Pattern

- S = Straight run
- PI = Standard patterns 2, 3 or 4 sided with 90° inside corners on the same plane¹
- PO = Standard patterns 2, 3 or 4 sided with 90° outside corners on the same plane¹
- PZ = Non-standard patterns and/or corners other than 90° on multiple planes, consult factory¹

Length

- A, B, C = specify inches to the nearest 0.25" (i.e. 72.25")
For patterns specify each length (i.e. 2 sided: A x B = 72.25" x 48"; 3 sided: A x B x C; 4 sided: A x B x A x B)
- For 2 and 4 foot fixtures to fit ceiling grids specify 24" and 48" lengths

Power²

- L = 3W/ft low power (WD 2.7 W/ft) (24V)
- M = 6W/ft mid power (WD 5.5 W/ft) (24V) (RGBW - 7.6 W/ft)
- H = 10W/ft high power (WD 8 W/ft) (24V)

CRI/CCT (90+ CRI)³

- 927 = 2700K
- 930 = 3000K
- 935 = 3500K
- 940 = 4000K
- WD = Warm Dimming 1800 - 3000K
- RGBW = 3000K White (M power only)

Driver (remote)⁴

- X = No driver, ordered separately
- S = Standard, non-dim driver 120-277V
- D010 = Osram, 10%, 0-10V dimming, 120-277V
- DPH = Phase Dimming, 1% dimming, 120V only
- L3DAE = Lutron Hi-lume 1% EcoSystem, 120-277V
- L3DOE = Lutron Hi-lume Premier 0.1% EcoSystem, 120-277V
- EL96 = Osram / EldoLED, 24V, 0.1% 0-10V Dimming
- DMX = Osram / EldoLED, 24V, 0.1% DMX Dimming

Lens

- OD = Satin opal diffuser (standard)
- SD = Satin clear diffuser
- MPL = Micro-prismatic lens

Finish⁵

- W = White, 15% gloss, RAL 9010 / Tiger Drylac 009/10120 (standard)
- B = Black, 15% gloss, RAL 9005 / Tiger Drylac 044/90053
- S = Silver, 15% gloss, RAL 9006 / Tiger Drylac 049/90500
- F = Custom finished trim, specify RAL

Options

- EM = Emergency (remote)
- WL = Wet Location Under Canopy / Cover⁶

Whitegoods reserves the right to change any information without prior notice.

Notes

- 1 See pattern spec sheet.
- 2 Wattage shown is for LED boards only, system wattage varies depending on driver selected.
- 3 Refer to specsheet for delivered lumen data for all product configurations.
- 4 Remote power supply required. See power supply page for details.
- 5 See Tiger Drylac color chart: inter-lux.com/tiger
- 6 Wet Location option available for OD / SD / MPL lenses and recessed / surface ceiling applications only.

20 Linear Recessed Flush

- Miniature, fully recessed line of light.
- Trimless and bezel trim for all types of hard ceilings.
- Seamless integration into any drywall, wood and metal surfaces.
- Straight runs and configurations with factory corners in exact lengths as specified.
- Multiple distribution options.
- 90+ CRI, 3 Steps MacAdam delivering excellent color rendering.
- Choice of White, RGBW and Warm Dim to emulate incandescent.
- Identical LED technology used throughout all Whitegoods Linears, Coves and Perimeter products deliver consistent quality and performance throughout a project.
- Made in USA.
- 5-year warranty.

Housing	Precision extruded aluminum for true dimensions and tolerances Integration into any ceiling type All low voltage connections made in the housing Luminaires snaps into the housing without tools Finishes: white, black, silver and custom
Integration	Fixation into gypsum, hard ceilings and all grid ceiling types
Distribution	Multiple lenses and louvers for general, accent, decorative and grazing applications
LED	Constant Voltage, 90+ CRI, 3 Steps MacAdam 120 nominal lumens/watt average (see spec sheet for delivered lumens) Conformal coated for protection against humidity optional (-WL) Warm Dim to emulate incandescent when dimming; 75 nominal lumens per watt average RGBW for color changing applications; 50 nominal lumens per watt average L70 (TM21 Projected 85C) Static White = 60,000 hours RGBW = 50,000 hours, WD = 36,000 hours
Lens	OD - Opal Diffuser provides even, continuous line of light and general illumination MPL - Micro-prismatic lens provides lower brightness, general illumination NL16 - Narrow Lens optic provides narrow beam for wall grazing applications LL45 - 45 Degree Louver in white, black and satin provides extreme low brightness BD - Block Diffuser of satin acrylic provides general illumination and decorative effect
Weight	2lbs per foot
Operating Temp	Suitable for operation in maximum ambient temperature of 35C (95F)
Warranty	5-year Limited (see complete company warranty information)
Certifications	ETL and ETL-C for dry and damp location, CE
Voltages	24V Fixture / 120-277VAC Driver (remote)

Lenses/Accessories

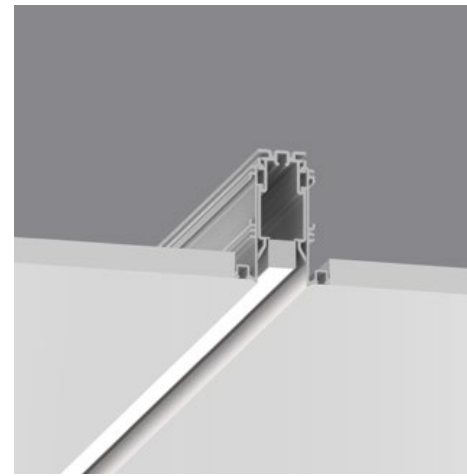
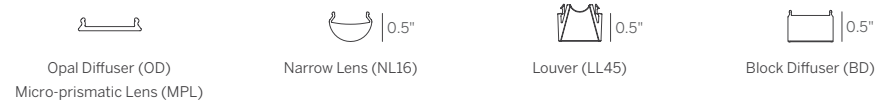

Recessed Plaster Trim (RPT)

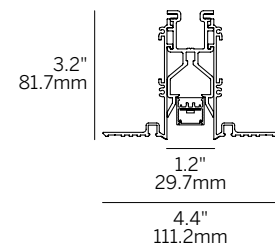

Recessed Plaster Trim (RPT)

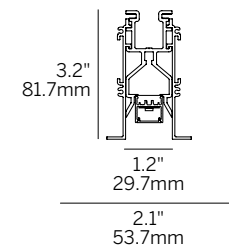

Recessed Bezel Trim (RBT)
Recessed Grid Trim (RGT9/
RGT15)

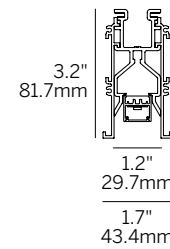

Recessed Return Trim (RRT)

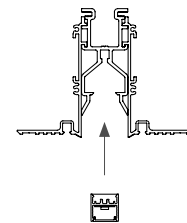

20 Linear Recessed Flush

Model	Fixation	Pattern	Length	Power ²	CRI/ CCT ³	Driver ⁴	Lens	Finish ⁷	Options
WG-20LRF	RPT RBT RRT RGT9 RGT15	S P ¹ PZ ¹	A A x B A x B x C A x B x A x B	L M H	927 930 935 940 WD RGBW	X S D010 DPH L3DAE L3DOE EL96 DMX	OD (std) MPL NL16 LL45B ⁵ LL45W ⁵ LL45S ⁵ BDO ⁶ BDC ⁶	W (std) B S F	EM WL ⁸

Model

- WG-20LRF = 20 Linear Recessed Flush

Fixation

- RPT = Recessed plaster trim
- RBT = Recessed bezel trim
- RRT = Recessed return trim
- RGT9 = Recessed grid trim 9/16"
- RGT15 = Recessed grid trim 15/16"

Pattern

- S = Straight run
- P = Standard patterns 2, 3 or 4 sided with 90° corners on the same plane¹
- PZ = Non-standard patterns and/or corners other than 90° on multiple planes, consult factory¹

Length

- A, B, C = specify inches to the nearest 0.25" (i.e. 72.25")
For patterns specify each length (i.e. 2 sided: A x B = 72.25" x 48"; 3 sided: A x B x C; 4 sided: A x B x A x B)
- For 2 and 4 foot fixtures to fit ceiling grids specify 24" and 48" lengths

Power²

- L = 3W/ft low power (WD 2.7 W/ft) (24V)
- M = 6W/ft mid power (WD 5.5 W/ft) (24V) (RGBW - 7.6 W/ft)
- H = 10W/ft high power (WD 8 W/ft) (24V)

CRI/CCT (90+ CRI)³

- 927 = 2700K
- 930 = 3000K
- 935 = 3500K
- 940 = 4000K
- WD = Warm Dimming 1800 - 3000K
- RGBW = 3000K White (M power only)

Driver (remote)⁴

- X = No driver, ordered separately
- S = Standard, non-dim driver 120-277V
- D010 = Osram, 10%, 0-10V dimming, 120-277V
- DPH = Phase Dimming, 1% dimming, 120V only
- L3DAE = Lutron Hi-lume 1% EcoSystem, 120-277V
- L3DOE = Lutron Hi-lume Premier 0.1% EcoSystem, 120-277V
- EL96 = Osram / EldoLED, 24V, 0.1% 0-10V Dimming
- DMX = Osram / EldoLED, 24V, 0.1% DMX Dimming

Lens

- OD = Satin opal diffuser (standard)
- MPL = Micro-prismatic lens
- NL16 = Linear narrow lens, 16°
- LL45B = Linear louver black⁵
- LL45W = Linear louver white⁵
- LL45S = Linear louver satin⁵
- BDO = Block Diffuser Opal⁶
- BDC = Block Diffuser Clear⁶

Finish⁷

- W = White, 15% gloss, RAL 9010 / Tiger Drylac 009/10120 (standard)
- B = Black, 15% gloss, RAL 9005 / Tiger Drylac 044/90053
- S = Silver, 15% gloss, RAL 9006 / Tiger Drylac 049/90500
- F = Custom finished trim, specify RAL

Options

- EM = Emergency (remote)
- WL = Wet Location Under Canopy / Cover⁸

Whitegoods reserves the right to change any information without prior notice.

Notes

- 1 See pattern spec sheet.
- 2 Wattage shown is for LED boards only, system wattage varies depending on driver selected.
- 3 Refer to specsheet for delivered lumen data for all product configurations.
- 4 Remote power supply required. See power supply page for details.
- 5 Louver available in 4.75" increments.
- 6 Butt seam (lens) when in continuous run, straight runs only.
- 7 See Tiger Drylac color chart: inter-lux.com/tiger
- 8 Wet Location option available for OD / MPL lenses and recessed / surface ceiling applications only.

20 Linear Recessed Regressed

- Miniature, recessed linear downlight with regressed lens for low brightness.
- Trimless and bezel trim for seamless integration into any drywall, wood and metal surfaces.
- Straight runs and configurations with factory corners in exact lengths as specified.
- Multiple distribution options.
- 90+ CRI, 3 Steps MacAdam delivering excellent color rendering.
- Choice of White, RGBW and Warm Dim to emulate incandescent.
- Identical LED technology used throughout all Whitegoods Linears, Coves and Perimeter products deliver consistent quality and performance throughout a project.
- Made in USA.
- 5-year warranty.

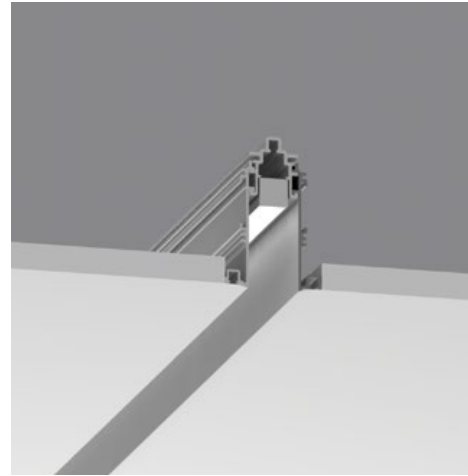

Recessed Plaster Trim (RPT)

Housing Precision extruded aluminum for true dimensions and tolerances

Integration into any ceiling type
All low voltage connections made in the housing
Luminaires snaps into the housing without tools
Finishes: white, black, silver and custom

Integration Fixation into gypsum, hard ceilings and all grid ceiling types

Distribution Multiple lenses and louvers for general, accent, decorative and grazing applications

LED Constant Voltage, 90+ CRI, 3 Steps MacAdam
120 nominal lumens/watt average (see spec sheet for delivered lumens)
Conformal coated for protection against humidity optional (-WL)
Warm Dim to emulate incandescent when dimming; 75 nominal lumens per watt average
RGBW for color changing applications; 50 nominal lumens per watt average
L70 (TM21 Projected 85C) Static White = 60,000 hours
RGBW = 50,000 hours, WD = 36,000 hours

Lens OD - Opal Diffuser provides even, continuous line of light and general illumination
SD - Satin Clear Diffuser provides high efficiency soft edge beam, general illumination
MPL - Micro-prismatic lens provides lower brightness, general illumination
NL16 - Narrow Lens optic provides narrow beam for wall grazing applications
LL45 - 45 Degree Louver in white, black and satin provides extreme low brightness

Driver Compatible with quality constant voltage drivers

Weight 2lbs per foot

Operating Temp Suitable for operation in maximum ambient temperature of 35C (95F)

Warranty 5-year Limited (see complete company warranty information)

Certifications ETL and ETL-C for dry and damp location, CE

Voltages 24V Fixture / 120-277VAC Driver (remote)

Lenses/Accessories

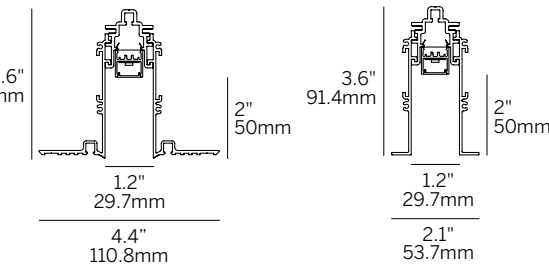
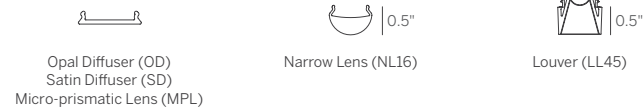

Recessed Plaster Trim (RPT)

Recessed Bezel Trim (RBT)
Recessed Grid Trim (RGT9/
RGT15)

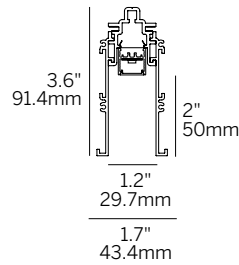

Recessed Return Trim (RRT)

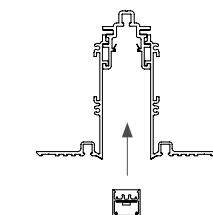

20 Linear Recessed Regressed

Model	Fixation	Pattern	Length	Power ²	CRI/ CCT ³	Driver ⁴	Lens	Finish ⁶	Options
WG-20LRR	RPT RBT RRT RGT9 RGT15	S P ¹ PZ ¹	A A x B A x B x C A x B x A x B	L M H	927 930 935 940 WD RGBW	X S D010 DPH L3DAE L3DOE EL96 DMX	OD (std) SD MPL NL16 LL45B ⁵ LL45W ⁵ LL45S ⁵	W (std) B S F	EM WL ⁷

Model

- WG-20LRR = 20 Linear Recessed Regressed

Fixation

- RPT = Recessed plaster trim
- RBT = Recessed bezel trim
- RRT = Recessed return trim
- RGT9 = Recessed grid trim 9/16"
- RGT15 = Recessed grid trim 15/16"

Pattern¹

- S = Straight run
- P = Standard patterns 2, 3 or 4 sided with 90° corners on the same plane¹
- PZ = Non-standard patterns and/or corners other than 90° on multiple planes, consult factory¹

Length

- A, B, C = specify inches to the nearest 0.25" (i.e. 72.25")
For patterns specify each length (i.e. 2 sided: A x B = 72.25" x 48"; 3 sided: A x B x C; 4 sided: A x B x A x B)
- For 2 and 4 foot fixtures to fit ceiling grids specify 24" and 48" lengths

Power²

- L = 3W/ft low power (WD 2.7 W/ft) (24V)
- M = 6W/ft mid power (WD 5.5 W/ft) (24V) (RGBW - 7.6 W/ft)
- H = 10W/ft high power (WD 8 W/ft) (24V)

CRI/CCT (90+ CRI)³

- 927 = 2700K
- 930 = 3000K
- 935 = 3500K
- 940 = 4000K
- WD = Warm Dimming 1800 - 3000K
- RGBW = 3000K White (M power only)

Driver (remote)⁴

- X = No driver, ordered separately
- S = Standard, non-dim driver 120-277V
- D010 = Osram, 10%, 0-10V dimming, 120-277V
- DPH = Phase Dimming, 1% dimming, 120V only
- L3DAE = Lutron Hi-lume 1% EcoSystem, 120-277V
- L3DOE = Lutron Hi-lume Premier 0.1% EcoSystem, 120-277V
- EL96 = Osram / EldoLED, 24V, 0.1% 0-10V Dimming
- DMX = Osram / EldoLED, 24V, 0.1% DMX Dimming

Lens

- OD = Satin opal diffuser (standard)
- SD = Satin clear diffuser
- MPL = Micro-prismatic lens
- NL16 = Linear narrow lens, 16°
- LL45B = Linear louver black⁵
- LL45W = Linear louver white⁵
- LL45S = Linear louver satin⁵

Finish⁶

- W = White, 15% gloss, RAL 9010 / Tiger Drylac 009/10120 (standard)
- B = Black, 15% gloss, RAL 9005 / Tiger Drylac 044/90053
- S = Silver, 15% gloss, RAL 9006 / Tiger Drylac 049/90500
- F = Custom finished trim, specify RAL

Options

- EM = Emergency (remote)
- WL = Wet Location Under Canopy / Cover⁷

Whitegoods reserves the right to change any information without prior notice.

Notes

- 1 See pattern spec sheet.
- 2 Wattage shown is for LED boards only, system wattage varies depending on driver selected.
- 3 Refer to specsheet for delivered lumen data for all product configurations.
- 4 Remote power supply required. See power supply page for details.
- 5 Louver available in 4.75" increments.
- 6 See Tiger Drylac color chart: inter-lux.com/tiger
- 7 Wet Location option available for OD / SD / MPL lenses and recessed / surface ceiling applications only.

20 Linear Perimeter Flush

- Perimeter lighting system with continuous line of light for general illuminating and to define an interior space.
- Soft-graze* option to control textured wall contrast and accommodate feature wall thickness.
- Trimless and bezel trim for seamless integration into any drywall, wood and metal surfaces.
- Straight runs and configurations with factory corners in exact lengths as specified.
- 90+ CRI, 3 Steps MacAdam delivering excellent color rendering.
- Choice of White, RGBW and Warm Dim to emulate incandescent.
- Identical LED technology used throughout all Whitegoods Linears, Coves and Perimeter products deliver consistent quality and performance throughout a project.
- Made in USA.
- 5-year warranty.

Housing	Precision extruded aluminum for true dimensions and tolerances Integration into any ceiling type All low voltage connections made in the housing Luminaires snaps into the housing without tools Finishes: white, black, silver and custom
Integration	Fixation into gypsum, hard ceilings and all grid ceiling types
Distribution	General, continuous
LED	Constant Voltage, 90+ CRI, 3 Steps MacAdam 120 nominal lumens/watt average (see spec sheet for delivered lumens) Conformal coated for protection against humidity optional (-WL) Warm Dim to emulate incandescent when dimming; 75 nominal lumens per watt average RGBW for color changing applications; 50 nominal lumens per watt average L70 (TM21 Projected 85C) Static White = 60,000 hours RGBW = 50,000 hours, WD = 36,000 hours
Lens	OD - Opal Diffuser provides even, continuous line of light and general illumination MPL - Micro-prismatic lens provides lower brightness, general illumination
Driver	Compatible with quality constant voltage drivers
Weight	2lbs per foot (20LPF); 3lbs per foot (20LPFSG)
Operating Temp	Suitable for operation in maximum ambient temperature of 35C (95F)
Warranty	5-year Limited (see complete company warranty information)
Certifications	ETL and ETL-C for dry and damp location, CE
Voltages	24V Fixture / 120-277VAC Driver (remote)

Lenses/Accessories

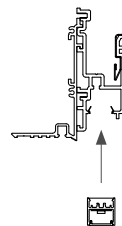

Opal Diffuser (OD)
Micro-prismatic Lens (MPL)

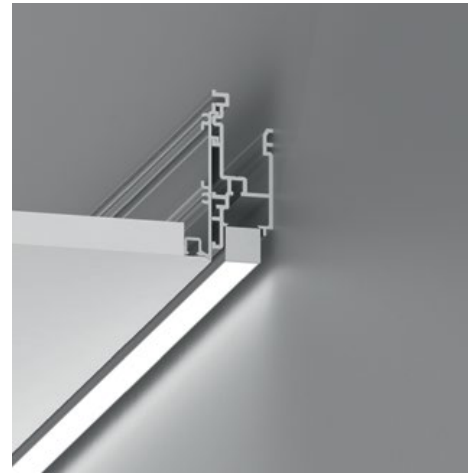

Recessed Plaster Trim (RPT)

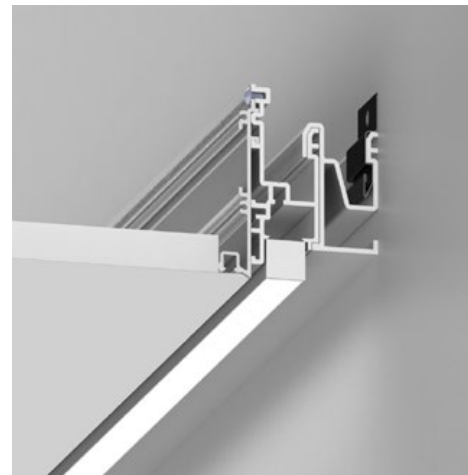

Soft Graze (SG) Recessed Plaster Trim (RPT)

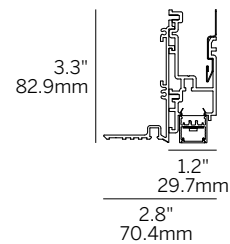

Recessed Plaster Trim (RPT)

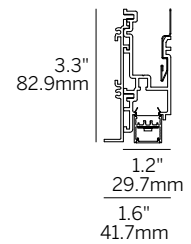

Recessed Bezel Trim (RBT)
Recessed Grid Trim (RGT9/RGT15)

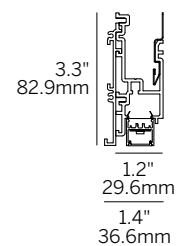

Recessed Return Trim (RRT)

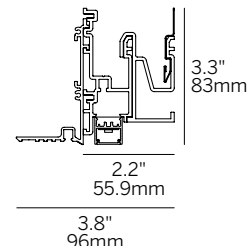

Soft Graze (SG)
Recessed Plaster Trim (RPT)

20 Linear Perimeter Flush

Model	Fixation	Pattern	Length	Power ²	CRI/CCT ³	Driver ⁴	Lens	Finish ⁵	Options
WG-20LPF	RPT	S	A	L	927	X	OD (std)	W (std)	EM
WG-20LPFSG	RBT	PI ¹	A x B	M	930	S	MPL	B (std)	WL ⁶
	RRT	PO ¹	A x B x C	H	935	D010		S	
	RGT9	PZ ¹	A x B x A x B		940	DPH		F	
	RGT15				WD	L3DAE			
					RGBW	L3DOE			
						EL96			
						DMX			

Model

- WG-20LPF = 20 Linear Perimeter Flush
- WG-20LPFSG = 20 Linear Perimeter Flush *Soft Graze*

Fixation

- RPT = Recessed plaster trim
- RBT = Recessed bezel trim
- RRT = Recessed return trim
- RGT9 = Recessed grid trim 9/16"
- RGT15 = Recessed grid trim 15/16"

Pattern

- S = Straight run
- PI = Standard patterns 2, 3 or 4 sided with 90° inside corners on the same plane¹
- PO = Standard patterns 2, 3 or 4 sided with 90° outside corners on the same plane¹
- PZ = Non-standard patterns and/or corners other than 90° on multiple planes, consult factory¹

Length

- A, B, C = specify inches to the nearest 0.25" (i.e. 72.25")
For patterns specify each length (i.e. 2 sided: A x B = 72.25" x 48"; 3 sided: A x B x C; 4 sided: A x B x A x B)
- For 2 and 4 foot fixtures to fit ceiling grids specify 24" and 48" lengths

Power²

- L = 3W/ft low power (WD 2.7 W/ft) (24V)
- M = 6W/ft mid power (WD 5.5 W/ft) (24V) (RGBW - 7.6 W/ft)
- H = 10W/ft high power (WD 8 W/ft) (24V)

CRI/CCT (90+ CRI)³

- 927 = 2700K
- 930 = 3000K
- 935 = 3500K
- 940 = 4000K
- WD = Warm Dimming 1800 - 3000K
- RGBW = 3000K White (M power only)

Driver (remote)⁴

- X = No driver, ordered separately
- S = Standard, non-dim driver 120-277V
- D010 = Osram, 10%, 0-10V dimming, 120-277V
- DPH = Phase Dimming, 1% dimming, 120V only
- L3DAE = Lutron Hi-lume 1% EcoSystem, 120-277V
- L3DOE = Lutron Hi-lume Premier 0.1% EcoSystem, 120-277V
- EL96 = Osram / EldoLED, 24V, 0.1% 0-10V Dimming
- DMX = Osram / EldoLED, 24V, 0.1% DMX Dimming

Lens

- OD = Satin opal diffuser (standard)
- MPL = Micro-prismatic lens

Finish⁵

- W = White, 15% gloss, Tiger Drylac 49/11350 (standard)
- B = Black, 15% gloss, Tiger Drylac 44/90053
- S = Silver, 15% gloss, Tiger Drylac 49/90500
- F = Custom finished trim, specify RAL

Options

- EM = Emergency (remote)
- WL = Wet Location Under Canopy / Cover⁶

Whitegoods reserves the right to change any information without prior notice.

Notes

- See pattern spec sheet.
- Wattage shown is for LED boards only, system wattage varies depending on driver selected.
- See spec page for delivered lumens.
- Remote power supply required. See power supply page for details.
- See Tiger Drylac color chart: inter-lux.com/tiger
- Wet Location option available for OD / MPL lenses and recessed / surface ceiling applications only.

20 Linear Perimeter Regressed

- Perimeter lighting system with regressed light source for general illumination and feature wall grazing.
- Recessed Luminaire allows the finished wall to continue above the ceiling plane for full wall illumination.
- Soft-graze option to control textured wall contrast and accommodate feature wall thickness.
- Trimless and bezel trim for seamless integration into any drywall, wood and metal surfaces.
- Straight runs and configurations with factory corners in exact lengths as specified.
- Removable light source sub assembly for ease of installation and maintenance.
- High efficiency linear LED in a range of outputs, including static white, tunable white, warm dim and RGBW.
- Remote driver, low voltage wiring.
- Lengths and angles factory cut to exact field dimensions.
- Mitered and welded corners available with continuous illumination.
- Made in the USA.

Housing Precision extruded aluminum for true dimensions and tolerances
Integration into any ceiling type
All low voltage connections made in the housing
Luminaires snaps into the housing without tools
Finishes: white, black, silver and custom

Integration Fixation into gypsum, hard ceilings and all grid ceiling types

Distribution Lenses and louvers for general and grazing applications

LED >90 CRI, 3-Step MacAdam, 2700-4000K static white
1.5W - 15W per foot, 180 nominal lumens per watt average, constant current
Tunable white 2200-4000K, 80 nominal lumens per watt average
Warm Dim to emulate incandescent when dimming; 75 nominal lumens per watt average
RGBW, 50 nominal lumens per watt
L70 (TM21 Projected 85C) Static White / Tunable White = 72,000 hours, RGBW = 50,000 hours, WD = 36,000 hours

Lens OD - Opal Diffuser provides even, continuous line of light and general illumination
SD - Satin Clear Diffuser provides high efficiency soft edge beam, general illumination
MPL - Micro-prismatic lens provides lower brightness, general illumination
NL16 - Narrow Lens optic provides narrow beam for wall grazing applications
LL45 - 45 Degree Louver in white, black or satin provides extreme low brightness

Driver Remote driver
Compatible with quality constant current (Static White / Tunable White) and constant voltage (WD / RGBW) drivers

Connectivity POE
Wireless

Weight 2lbs per foot (20LPR); 3lbs per foot (20LPRSG)

Operating Temp Suitable for operation in maximum ambient temperature of 35C (95F)

Warranty 5-year Limited (see complete company warranty information)

Certifications ETL and ETL-C for dry and damp location, CE

Voltages Low Voltage Fixture / 120-277VAC Driver (remote)

Lenses/Accessories

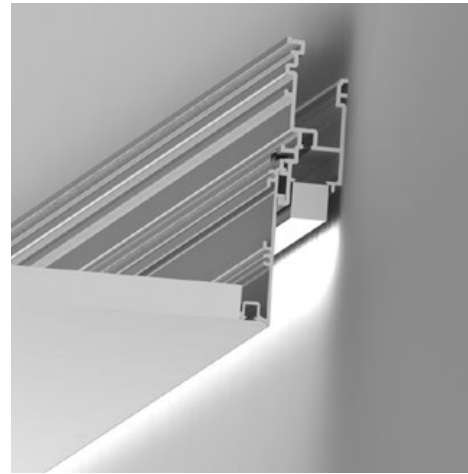
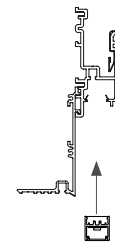

Recessed Plaster Trim (RPT)

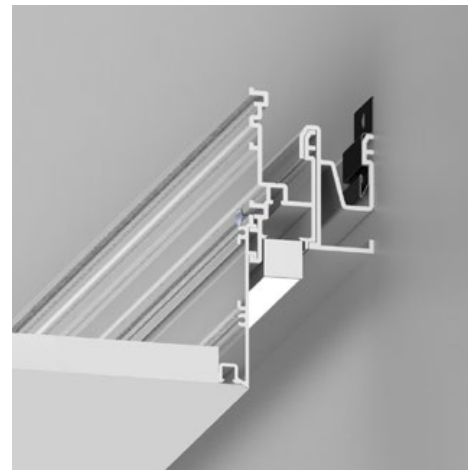

Soft Graze (SG) Recessed Plaster Trim (RPT)

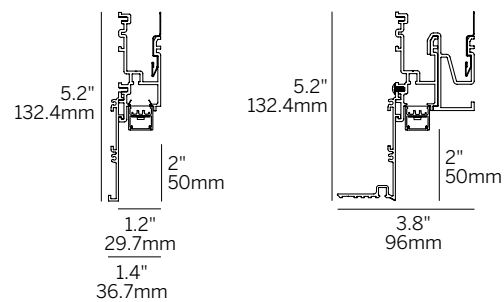
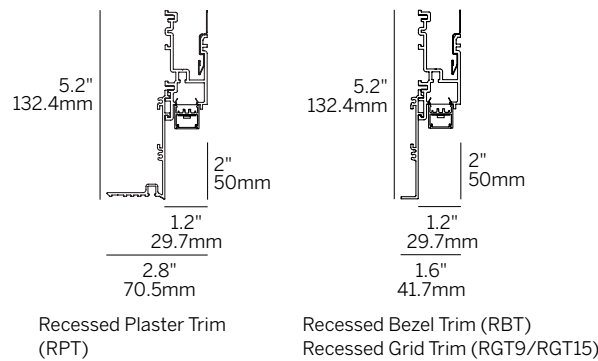

Recessed Return Trim (RRT) Soft Graze (SG) Recessed Plaster Trim (RPT)

20 Linear Perimeter Regressed

Model	Fixation	Pattern	Length	Power ²	CRI/CCT ³	Driver ⁵	Lens	Finish ⁷	Options
WG-20LPR WG-20LPRSG	RPT RBT RRT RGT9 RGT15	S PI ¹ PO ¹ PZ ¹	A A x B A x B x C A x B x A x B	P0 P1 P2 P3	927 930 935 940 TW ⁴	E1 L1 POE BT DALI TQ	OD (std) SD MPL NL16 LL45B ⁶ LL45W ⁶ LL45S ⁶	W (std) B S F	EM WL ⁸
				L M H	WD RGBW	DO10 DPH L3DAE L3DOE EL96 DMX			

Model

- WG-20LPR = 20 Linear Perimeter Regressed
- WG-20LPRSG = 20 Linear Perimeter Regressed Soft Graze

Fixation

- RPT = Recessed plastertrim
- RBT = Recessed bezel trim
- RRT = Recessed return trim
- RGT9 = Recessed grid trim 9/16"
- RGT15 = Recessed grid trim 15/16"

Pattern

- S = Straight run
- PI = Standard patterns 2, 3, or 4 sided with 90° inside corners on the same plane¹
- PO = Standard patterns 2, 3 or 4 sided with 90° outside corners on the same plane¹
- PZ = Non-standard patterns and/or corners other than 90° on multiple planes, consult factory¹

Length

- A, B, C = specify inches to the nearest 0.25" (i.e. 72.25")
For patterns specify each length (i.e. 2 sided: A x B = 72.25" x 48"; 3 sided: A x B x C; 4 sided: A x B x A x B)
- For 2 and 4 foot fixtures to fit ceiling grids specify 24" and 48" lengths

Power²

- P0 = 1.5 W/ft
- P1 = 3 W/ft
- P2 = 6 W/ft
- P3 = 10 W/ft
- L = 2.7 W/ft WD low power (24V)
- M = 5.5 W/ft WD medium power (24V) [RGBW 7.6 W/ft]
- H = 8 W/ft WD high power (24V)

CRI / CCT (90+ CRI minimum)³

- 927 = 2700K
- 930 = 3000K
- 935 = 3500K
- 940 = 4000K
- TW = Tunable White 2200K - 4000K⁴
- WD = Warm Dim 1800K-3000K
- RGBW = 3000K White

Whitegoods reserves the right to change any information without prior notice.

Notes

- See pattern specsheet.
- Wattage shown does not include power supplies/drivers.
- Refer to specsheet for delivered lumen data for all product configurations.
- TW offered up to P3 (10W/ft) power level.
- See power supply page for details.
- Louver available in 4.75" increments, straight runs only.
- See Tiger Drylac color chart: inter-lux.com/tiger.
- Wet Location option available for OD / SD / MPL lenses and recessed / surface ceiling applications only.

Driver (remote)⁵

- E1 = eldoLED 0.1% dimming, 0-10V (120-277V)
- L1 = Lutron 1% dimming, EcoSystem (120-277V)
- POE = Power over Ethernet
- BT = Wireless CAS - Casambi (Must specify BT with E1 or DALI)
- DALI = eldoLED DALI DT8 0.1% (120-277V)
- TQ = T-series for Lutron Quantum 0.1 % (120-277V) [TW only]
- DO10 = Osram, 10%, 0-10V dimming, 120-277V [WD only]
- DPH = Phase Dimming, 1% dimming, 120V only [WD only]
- L3DAE = Lutron Hi-lume 1% EcoSystem, 120-277V [WD only]
- L3DOE = Lutron Hi-lume Premier 0.1% EcoSystem, 120-277V (remote) [WD only]
- DMX = Osram + eldoLED 24V, DMX dimming [WD + RGBW Only]

Lens

- OD = Satin opal diffuser (standard)
- SD = Satin clear diffuser
- MPL = Micro-prismatic lens
- NL16 = Linear narrow lens, 16°
- LL45B = Linear louver black⁶
- LL45W = Linear louver white⁶
- LL45S = Linear louver satin⁶

Finish⁷

- W = White, 15% gloss, RAL 9010 / Tiger Drylac 009/10120 (standard)
- B = Black, 15% gloss, RAL 9005 / Tiger Drylac 049/90053
- S = Silver, 15% gloss, RAL 9006 / Tiger Drylac 049/90500
- F = Custom finished trim, specify RAL

Options

- EM = Emergency LED driver (remote)
- WL = Wet Location Under Canopy / Cover⁸

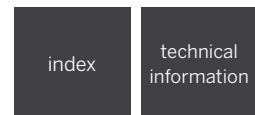

20 Linear Mini Edgeless Cove

- Extremely small knife-edge cove utilizing the 20Linear for general indirect distribution.
- Continuous mounting to any desired length.
- Luminaire has opal or satin diffuser options for even illumination, elimination of glare and high efficiency.
- Lengths and angles factory cut to exact field dimensions - housing may be field cut.
- Removable light source sub assembly for ease of installation and maintenance.
- High efficiency linear LED in a range of outputs, including static white, tunable white, warm dim and RGBW.
- Mini size requires remote driver.
- Lengths and angles factory cut to exact field dimensions.
- Mitered corners available with continuous illumination.
- Made in the USA.



Housing	Precision extruded aluminum for true dimensions and tolerances Alignment hardware for invisible seam from below Housing provided in any exact length, or field cut Snap-in LED insert for easy installation Standard and tailored lengths Corners: standard and non-standard Finishes: RAL 9010 white 15% gloss
Integration	Seamless, architectural integration into gypsum for minimal visual detail and true knife edge
Distribution	Wide indirect distribution fully illuminates the cove and redirects light into the adjacent space
LED	>90 CRI, 3-Step MacAdam, 2700-4000K static white 1.5W - 15W per foot, 180 nominal lumens per watt average, constant current Tunable white 2200-4000K, 80 nominal lumens per watt average Warm Dim to emulate incandescent when dimming; 75 nominal lumens per watt average RGBW, 50 nominal lumens per watt L70 (TM21 Projected 85C) Static White / Tunable White = 72,000 hours, RGBW = 50,000 hours, WD = 36,000 hours
Lens	SD - satin clear dust cover for wipe down applications OD - Opal diffuser provides even, continuous line of light and general illumination
Driver	Remote driver Compatible with quality constant current (Static White / Tunable White) and constant voltage (WD / RGBW) drivers
Connectivity	POE Wireless
Weight	1lb per foot
Operating Temp	Suitable for operation in maximum ambient temperature of 35C (95F)
Warranty	5-year Limited (see complete company warranty information)
Certifications	ETL and ETL-C for dry and damp location, CE
Voltages	Low Voltage Fixture, 120-277VAC Driver (remote)

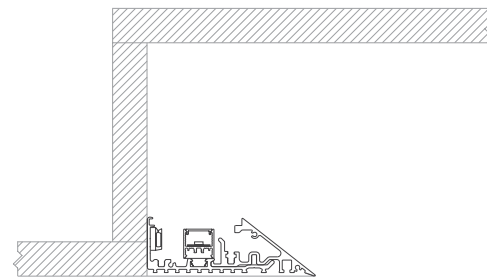
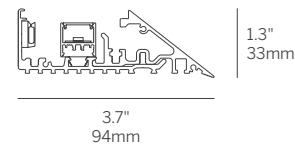

Gypsum Ceiling Mounting Options
4" minimum offset, 12" typical offset

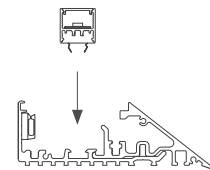

Lenses/Accessories



Satin Diffuser (SD)
Opal Diffuser (OD)

20 Linear Mini Edgeless Cove

Model	Fixation	Pattern	Length	Power ³	CRI/ CCT ⁴	Driver ⁶	Lens	Finish ⁷	Options
WG-20MEC	RPT	S ¹ PC ² PR ² PPI ² PPO ² PZ ²	A A x B A x B x C A x B x A x B	P0 P1 P2 P3	927 930 935 940 TW ⁵	E1 L1 POE BT DALI TQ	SD (std) OD	W (std) F	CDC EM
				L M H	WD RGBW	DO10 DPH L3DAE L3DOE EL96 DMX			

Model

- WG-20MEC = 20 Linear Mini Edgeless Cove

Fixation

- RPT = Recessed plaster trim

Pattern

- S = Straight run¹
- PC = Standard patterns coffer 2, 3 or 4 sided with 90° inside corners²
- PR = Standard patterns raft 2, 3 or 4 sided with 90° outside corners²
- PPI = Wall to wall / wall to ceiling, 90° inside corner²
- PPO = Wall to wall / wall to ceiling, 90° outside corner²
- PZ = Non-standard patterns and/or corners other than 90°; consult factory²

Length

- A, B, C = specify inches to the nearest 0.25" (i.e. 72.25")
For patterns specify each length (i.e. 2 sided: A x B = 72.25" x 48"; 3 sided: A x B x C; 4 sided: A x B x A x B)

Power³

- P0 = 1.5 W/ft
- P1 = 3 W/ft
- P2 = 6 W/ft
- P3 = 10 W/ft
- L = 2.7 W/ft WD low power (24V)
- M = 5.5 W/ft WD medium power (24V) [RGBW 7.6 W/ft]
- H = 8W/ft WD high power (24V)

CRI/CCT (90+ CRI minimum)⁴

- 927 = 2700K
- 930 = 3000K
- 935 = 3500K
- 940 = 4000K
- TW = Tunable White 2200K - 4000K⁵
- WD = Warm Dim 1800K-3000K
- RGBW = 3000K White

Driver (remote)⁵

- E1 = eldoLED 0.1% dimming, 0-10V (120-277V)
- L1 = Lutron 1% dimming, EcoSystem (120-277V)
- POE = Power over Ethernet
- BT = Wireless CAS - Casambi (Must specify BT with E1 or DALI)
- DALI = eldoLED DALI DT8 0.1% (120-277V)
- TQ = T-series for Lutron Quantum 0.1% (120-277V) [TW only]
- DO10 = Osram, 10%, 0-10V dimming, 120-277V [WD only]
- DPH = Phase Dimming, 1% dimming, 120V only [WD only]
- L3DAE = Lutron Hi-lume 1% EcoSystem, 120-277V [WD only]
- L3DOE = Lutron Hi-lume Premier 0.1% EcoSystem, 120-277V (remote) [WD only]
- DMX = Osram + eldoLED 24V, DMX dimming [WD + RGBW Only]

Lens

- SD = Satin clear diffuser (standard)
- OD = Satin opal diffuser

Finish⁶

- W = White, 15% gloss, RAL 9010 / Tiger Drylac 009/10120 (standard)
- F = Custom finish, specify RAL

Options

- CDC = Clear dust cover
- EM = Emergency (remote)

Whitegoods reserves the right to change any information without prior notice.

Notes

- Standard setup assumes the cove ends at a perpendicular wall and the LED board is setback from the end to minimize light on the perpendicular wall. Contact us for options.
- See pattern specsheet.
- Wattage shown does not include power supplies/drivers.
- Refer to specsheet for delivered lumen data for all product configurations.
- TW offered up to P3 (10W/ft) power level.
- See power supply page for details.
- See Tiger Drylac color chart: inter-lux.com/tiger.

20 Linear Mini Z Cove

- Miniature continuous perimeter light with knife edge detail.
- Flush snap-in Opal Diffuser (standard) for evenly illuminated lens.
- Flush snap-in Satin Diffuser or Micro-prismatic lens for maximum efficiency.
- Trimless installation into drywall without disturbing the ceiling structure.
- Snap-in LED fixture for easy installation and maintenance
- Continuous mounting to any desired length.
- Removable light source sub assembly for ease of installation and maintenance.
- High efficiency linear LED in a range of outputs, including static white, tunable white, warm dim and RGBW.
- Remote driver, low voltage wiring.
- Lengths and angles factory cut to exact field dimensions.
- Mitered and welded corners available with continuous illumination.
- Made in the USA.

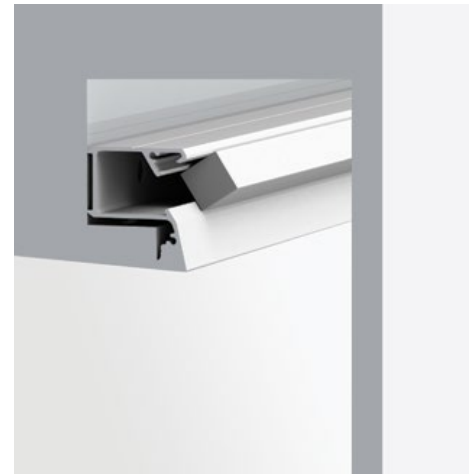

Housing	Precision extruded aluminum for true dimensions and tolerances Alignment hardware for invisible seam from below Housing provided in any exact length Snap-in LED insert for easy final installation Standard and tailored lengths Corners: standard and non-standard Finishes: RAL 9010 white 15% gloss
Integration	Seamless, architectural integration into gypsum walls and ceilings
Distribution	Continuous even illumination using an opal lens for homogeneous lens appearance, or satin diffuser / micro-prismatic lens for higher efficiency
LED	>90 CRI, 3-Step MacAdam, 2700-4000K static white 1.5W - 15W per foot, 180 nominal lumens per watt average, constant current Tunable white 2200-4000K, 80 nominal lumens per watt average Warm Dim to emulate incandescent when dimming; 75 nominal lumens per watt average RGBW, 50 nominal lumens per watt L70 (TM21 Projected 85C) Static White / Tunable White = 72,000 hours, RGBW = 50,000 hours, WD = 36,000 hours
Lens	OD - Opal Diffuser provides even, continuous line of light and general illumination SD - Satin Clear Diffuser provides high efficiency soft edge beam, general illumination MPL - Micro-prismatic lens provides lower brightness, general illumination
Driver	Remote driver Compatible with quality constant current (Static White / Tunable White) and constant voltage (WD / RGBW) drivers
Connectivity	POE Wireless
Weight	3lbs per foot
Operating Temp	Suitable for operation in maximum ambient temperature of 35C (95F)
Warranty	5-year Limited (see complete company warranty information)
Certifications	ETL and ETL-C for dry and damp location, CE
Voltages	Low Voltage Fixture / 120-277VAC Driver (remote)

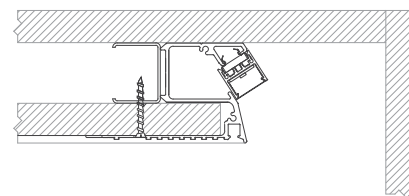
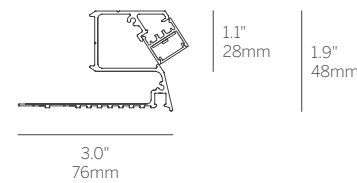

Gypsum Ceiling Mounting Options
2.5" minimum offset, 6" typical offset

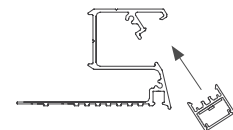

Lenses/Accessories

- Opal Diffuser (OD)
- Satin Diffuser (SD)
- Micro-prismatic Lens (MPL)

index technical information

20 Linear Mini Z Cove

Model	Fixation	Pattern	Length	Power ²	CRI/CCT ³	Driver ⁵	Lens	Finish ⁶	Options
WG-MZC	RPT	S PI ¹ PO ¹ PZ ¹	A A x B A x B x C A x B x A x B	P0 P1 P2 P3	927 930 935 940 TW ⁴	E1 L1 POE BT DALI TQ	OD (std) SD MPL	W (std) F	EM
				L M H	WD RGBW	D010 DPH L3DAE L3D0E EL96 DMX			

Model

- WG-20MZC = 20 Linear Mini Z Cove

Fixation

- RPT = Recessed plaster trim

Pattern

- S = Straight run
- PI = Standard patterns 2, 3, or 4 sided with 90° inside corners on the same plane¹
- PO = Standard patterns 2, 3 or 4 sided with 90° outside corners on the same plane¹
- PZ = Non-standard patterns and/or corners other than 90°, consult factory¹

Length

- A, B, C = specify inches to the nearest 0.25" (i.e. 72.25")
For patterns specify each length (i.e. 2 sided: A x B = 72.25" x 48"; 3 sided: A x B x C; 4 sided: A x B x A x B)

Power²

- P0 = 1.5 W/ft
- P1 = 3 W/ft
- P2 = 6 W/ft
- P3 = 10 W/ft
- L = 2.7 W/ft WD low power (24V)
- M = 5.5 W/ft WD medium power (24V) [RGBW 7.6 W/ft]
- H = 8W/ft WD high power (24V)

CRI / CCT (90+ CRI minimum)³

- 927 = 2700K
- 930 = 3000K
- 935 = 3500K
- 940 = 4000K
- TW = Tunable White 2200K - 4000K⁴
- WD = Warm Dim 1800K-3000K
- RGBW = 3000K White

Driver (remote)⁵

- E1 = eldoLED 0.1% dimming, 0-10V (120-277V)
- L1 = Lutron 1% dimming, EcoSystem (120-277V)
- POE = Power over Ethernet
- BT = Wireless CAS - Casambi (Must specify BT with E1 or DALI)
- DALI = eldoLED DALI DT8 0.1% (120-277V)
- TQ = T-series for Lutron Quantum 0.1 % (120-277V) [TW only]
- D010 = Osram, 10%, 0-10V dimming, 120-277V [WD only]
- DPH = Phase Dimming, 1% dimming, 120V only [WD only]
- L3DAE = Lutron Hi-lume 1% EcoSystem, 120-277V [WD only]
- L3D0E = Lutron Hi-lume Premier 0.1% EcoSystem, 120-277V (remote) [WD only]
- DMX = Osram + eldoLED 24V, DMX dimming [WD + RGBW Only]

Lens

- OD = Satin opal diffuser (standard)
- SD = Satin clear diffuser
- MPL = Micro-prismatic lens

Finish⁶

- W = White, 15% gloss, RAL 9010 / Tiger Drylac 009/10120 (standard)
- F = Custom finish, specify RAL

Finish

- EM = Emergency LED driver (remote)

Whitegoods reserves the right to change any information without prior notice.

Notes

- 1 See pattern specs sheet.
- 2 Wattage shown does not include power supplies/drivers.
- 3 Refer to specs sheet for delivered lumen data for all product configurations.
- 4 TW offered up to P3 (10W/ft) power level.
- 5 See power supply page for details.
- 6 See Tiger Drylac color chart: inter-lux.com/tiger.

20 Linear Under Cabinet

- Under cabinet and task light.
- Available in standard cabinet lengths and custom lengths.
- Mounts with invisible clip or magnet.
- On/off switch at fixture end with 120VAC plug-in driver.
- 90+ CRI, 3 Steps MacAdam delivering excellent color rendering.
- Identical LED technology used throughout all Whitegoods Linears, Coves and Perimeter products deliver consistent quality and performance throughout a project.
- Made in USA.
- 5-year warranty.

Housing	Precision extruded aluminum for true dimensions and tolerances Finishes: white and silver
Integration	Invisible screw-mount clip or magnet
Distribution	Wide angle illumination
LED	Constant Voltage, 90+ CRI, 3 Steps MacAdam 120 nominal lumens/watt average (see spec sheet for delivered lumens) L70 (TM21 Projected 85C) Static White = 60,000 hours
Lens	OD - Opal Diffuser provides even, continuous line of light and general illumination SD - Satin Clear Diffuser provides high efficiency soft edge beam, general illumination MPL - Micro-prismatic lens provides lower brightness, general illumination
Driver	120VAC plug-in
Weight	0.5lbs per foot
Operating Temp	Suitable for operation in maximum ambient temperature of 35C (95F)
Warranty	5-year Limited (see complete company warranty information)
Certifications	ETL and ETL-C for dry and damp location, CE
Voltages	120VAC



Under Cabinet (UC)

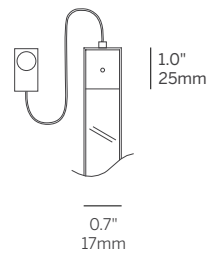

Total Length includes 1" for switch.
1" clearance required for cable.

Lenses/Accessories

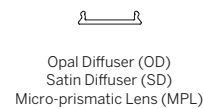

20 Linear Under Cabinet

Model	Fixation	Pattern	Length	Power ¹	CRI/ CCT ²	Driver	Lens	Finish ³
WG-20LUC	MM SC	S	18	L	927	S	OD (std) SD MPL	W (std) S
			24	M	930			
			30	H	935			
			36		940			
			42					
			48					

Model

- WG-20LUC = 20 Linear Under Cabinet

Fixation

- MM = Magnetic mounting
- SC = Screw clip

Pattern

- S = Straight run (for other product configurations see 20LDL-SM)

Length

Total length includes 1" for switch, requires 1" clearance for cable

- 18 = 18"
- 24 = 24"
- 30 = 30"
- 36 = 36"
- 42 = 42"
- 48 = 48"

Power¹

- L = 3W/ft low power (24V)
- M = 6W/ft mid power (24V)
- H = 10W/ft high power (24V)

CRI/CCT (90+ CRI)²

- 927 = 2700K
- 930 = 3000K
- 935 = 3500K
- 940 = 4000K

Driver (plug-in)

- S = Standard driver 120 - 240V, 50 - 60 Hz

Lens

- OD = Satin opal diffuser (standard)
- SD = Satin clear diffuser
- MPL = Micro-prismatic lens

Finish³

- W = White, 15% gloss, RAL 9010 / Tiger Drylac 009/10120 (standard)
- S = Silver, 15% gloss, RAL 9006 / Tiger Drylac 049/90500

Whitegoods reserves the right to change any information without prior notice.

Notes

- 1 Wattage shown is for LED boards only, system wattage varies depending on driver selected.
- 2 Refer to specsheet for delivered lumen data for all product configurations.
- 3 See Tiger Drylac color chart: inter-lux.com/tiger

20 Linear Wand

- Standard Opal Diffuser for even illumination and no LED appearance.
- On / Off switch with 118" cable and plug, standard.
- 90+ CRI, 3 Steps MacAdam delivering excellent color rendering.
- Identical LED technology used throughout all Whitegoods Linears, Coves and Perimeter products deliver consistent quality and performance throughout a project.
- Made in USA.
- 5-year warranty.



Housing Precision extruded aluminum for true dimensions and tolerances
Built to cabinet length specifications
Finishes: white

Integration Magnet mount

Distribution Wide angle illumination

LED Constant Voltage, 90+ CRI, 3 Steps MacAdam
120 nominal lumens/watt average (see spec sheet for delivered lumens)
L70 (TM21 Projected 85C) Static White = 60,000 hours

Lens OD - Opal Diffuser provides even, continuous line of light and general illumination
SD - Satin Clear Diffuser provides high efficiency soft edge beam, general illumination
MPL - Micro-prismatic lens provides lower brightness, general illumination
NL16 - Narrow Lens optic provides narrow beam for wall grazing applications
LL45 - 45 Degree Louver in white, black or satin provides extreme low brightness
BD - Block Diffuser of satin acrylic provides general illumination and decorative effect
ROD - Round Opal Diffuser 0.8" diameter provides general illumination

Driver 120VAC plug-in

Weight 0.5lbs per foot

Operating Temp Suitable for operation in maximum ambient temperature of 35C (95F)

Warranty 5-year Limited (see complete company warranty information)

Certifications ETL and ETL-C for dry and damp location, CE

Voltages 120VAC

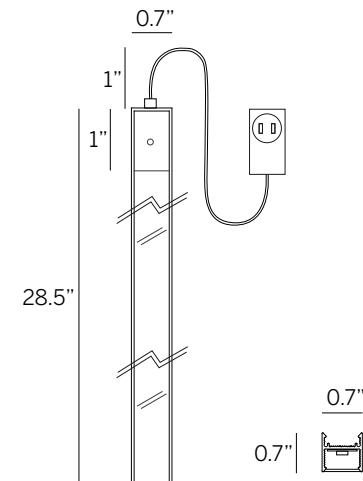

Total Length includes 1" for switch.
1" clearance required for cable.

20 Linear Wand

Model	Fixation	Pattern	Length	Power ¹	CRI/CCT ²	Driver ³	Lens	Finish ⁴
WG-WAND	MM	S	28.5	M	927 930 935 940	S	OD (std) SD MPL NL16 LL45B LL45W LL45S BDO BDC ROD	W (std)

Model

- WG-WAND = 20 Linear Wand

Fixation

- MM = Magnetic mounting

Pattern

- S = Straight run

Length

Total length includes 1" for switch, requires 1" clearance for cable

- 28.5 = 28.5"

Power¹

- M = 6W/ft mid power (24V)

CRI/CCT (90+ CRI)²

- 927 = 2700K
- 930 = 3000K
- 935 = 3500K
- 940 = 4000K

Driver (plug-in)³

- S = Standard driver 120 - 240V, 50 - 60 Hz

Lens

- OD = Satin opal diffuser (standard)
- SD = Satin clear diffuser
- MPL = Micro-prismatic lens
- NL16 = Linear narrow lens, 16°
- LL45B = Linear louver black
- LL45W = Linear louver white
- LL45S = Linear louver satin
- BDO = Block Diffuser Opal
- BDC = Block Diffuser Clear
- ROD = Round opal diffuser

Finish⁴

- W = White, 15% gloss, RAL 9010 / Tiger Drylac 009/10120 (standard)

Lenses/Accessories



Opal Diffuser (OD)
Satin Diffuser (SD)
Micro-prismatic Lens (MPL)



Narrow Lens (NL16)



Louver (LL45)



Block Diffuser (BD)



Round Opal Diffuser (ROD)

index

technical
information

Whitegoods reserves the right to change any information without prior notice.

Notes

- Wattage shown is for LED boards only, system wattage varies depending on driver selected.
- Refer to specsheet for delivered lumen data for all product configurations.
- 24V fixture supplied complete with individual socket mount power supply 120-240V, 50-60 Hz and feed cable.
- See Tiger Drylac color chart: inter-lux.com/tiger

Photo Credits

inside front cover - page 1

project BWI Airport Concourse D
location Baltimore, MD
architect JMT Architecture
lighting design MCLA
photography Nathan Cox

page 4 - 5, 28 - 29

project American Bankers Association
location Washington, DC
architect OTJ Architects
lighting design CM Kling
photography Trent Bell

page 6 - 7, 36 - 37, 64 - 65

project Duke Energy 21st floor
location Charlotte, NC
architect Gensler
photography Devon Banks

page 10 - 11

project Fannie Mae, Midtown Center
location Washington, DC
architect SHoP Architects
lighting design MCLA
photography Ty Cole/OTTO

page 12 - 13

project HuntonBrady Architects Office
location Orlando, FL
architect HuntonBrady Architects
photography Laurence F. Taylor

page 14 - 15

project Antunovich Associates
location Washington, DC
architect Antunovich Associates
photography Kenneth M Wyner

page 17, 50

project Four to Eight Restaurant
location London, UK
architect ATELIERwest
lighting design EPOS Design

page 20

project Massachusetts Biotech Company
location Watertown, MA
lighting design Lam Partners
photography © Lam Partners

page 22 - 23

project Private Residence
location Ellicott City, MD
architect greg(g) horgan architecture
photography Michael K. Wilkinson

page 24 - 25

project IDA Headquarters
location Washington, DC
architect KGD Architecture
photography Kristopher Ilich

page 26 - 27, 49

project Friends of the Earth
location Washington, DC
architect greg(g) horgan architecture
photography Michael K. Wilkinson

page 38 - 39

project Axinn Veltrop & Harkrider
location Washington, DC
architect OTJ Architects
photography Eric Laignel

page 44 - 45

project 1600 Market Street
location Philadelphia, PA
architect Collective Architecture
lighting design CM Kling
photography Max Cuzmuc

page 46 - 47

project ModivCare
location Denver, CO
lighting design ME Engineers
photography Jess Blackwell

page 53

project Palmgren House
location Stockholm, Sweden
architect John Pawson
photography Gilbert McCarragher

page 54

project 95 Wigmore Street
location London, UK
architect ORMS
lighting design Mindseye
photography Andy Spain

page 56

project The Core, Eden Project
location Cornwall, UK
architect Grimshaw Architects
lighting design Mindseye
photography Andy Spain

page 59

project Venable LLP
location Washington, DC
architect Alliance Architecture
lighting design MCLA
photography Robert Benson

page 62 - 63

project Vanderbilt University
location Nashville, TN
architect Goodwyn Mills Cawood (GMC)
photography Aerial Innovations Southeast

inside back cover

project Memphis Convention Center
location Memphis, TN
lighting design CM Kling
photography Ken West



The application of light to the surfaces around us is a critical factor in our perception of any space.

When proper consideration is given to the architecture, function and the desired atmosphere, lighting can become a truly integrated part of the overall environment being created, often unseen although defining and enhancing the space.