

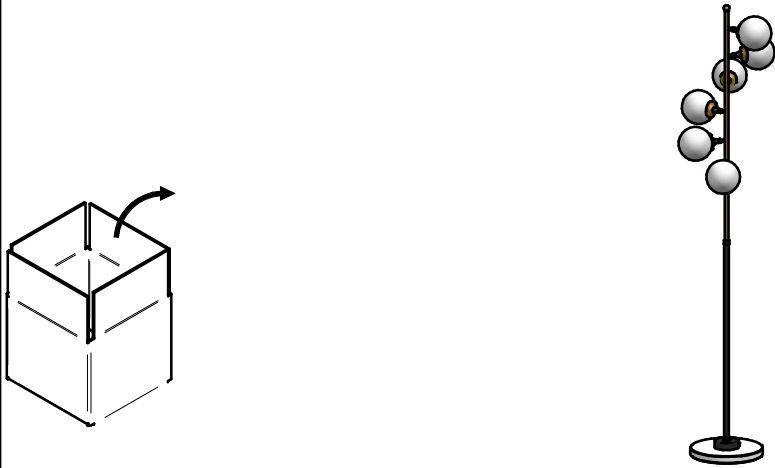

GALASSIA
FLOOR LAMP
FAMILY

E9560



WARNING:

INSTALL PRODUCT IN ACCORDANCE WITH LOCAL AND NATIONAL ELECTRICAL CODES BY A QUALIFIED ELECTRICIAN



WARNING:

FAILURE TO COMPLY WITH THE INSTALLATION INSTRUCTIONS MAY RESULT IN DEATH OR SEVERE INJURY.



WARNING:

READ ALL SAFETY INSTRUCTIONS INCLUDED WITH LUMINAIRE BEFORE INSTALLING LUMINAIRE. SAVE INSTRUCTIONS FOR FUTURE USE.

CAUTION:

THIS IS AN ELECTRONIC DEVICE. CARE MUST BE TAKEN DURING STORAGE AND HANDLING. STORE IN A CLEAN, COOL AND DRY LOCATION. ELECTROSTATIC DISCHARGE (ESD) CAN HARM THIS PRODUCT. AVOID STATIC DISCHARGE WHILE HANDLING THIS PRODUCT.

CAUTION:

INTER-LUX IS NOT RESPONSIBLE FOR THE STRUCTURAL INTEGRITY OF THE BUILDING TO SUPPORT THE LUMINAIRE. ADDITIONAL BACKING MAY BE REQUIRED.

LOCATE AND REVIEW ANY CONSTRUCTION PLANS AND INTER-LUX RECORD DRAWINGS FOR ALL FIXTURE RUNS. IT IS RECOMMENDED TO LOCARE AND LAY OUT ALL COMPONENTS FOR EACH FIXTURE "RUN". A FIXTURE RUN TYPICALLY CONSISTS OF JOINERS, LENGHTS OF HOUSING, AND ENDCAPS. BE SURE TO IDENTIFY ALL CORRECT LENGHTS FOR EACH FIXTURE RUN.

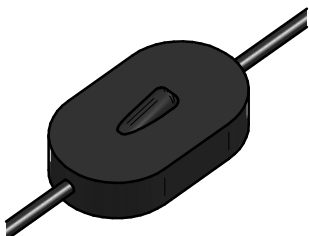

OFF

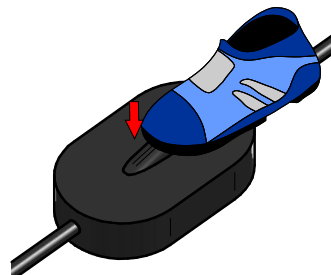
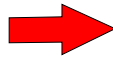

ON

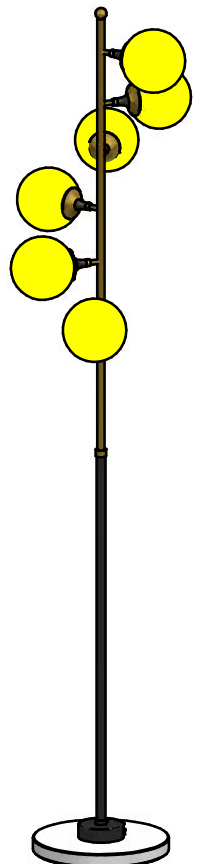
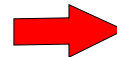



GALASSIA
FLOOR LAMP
FAMILY

 E9560

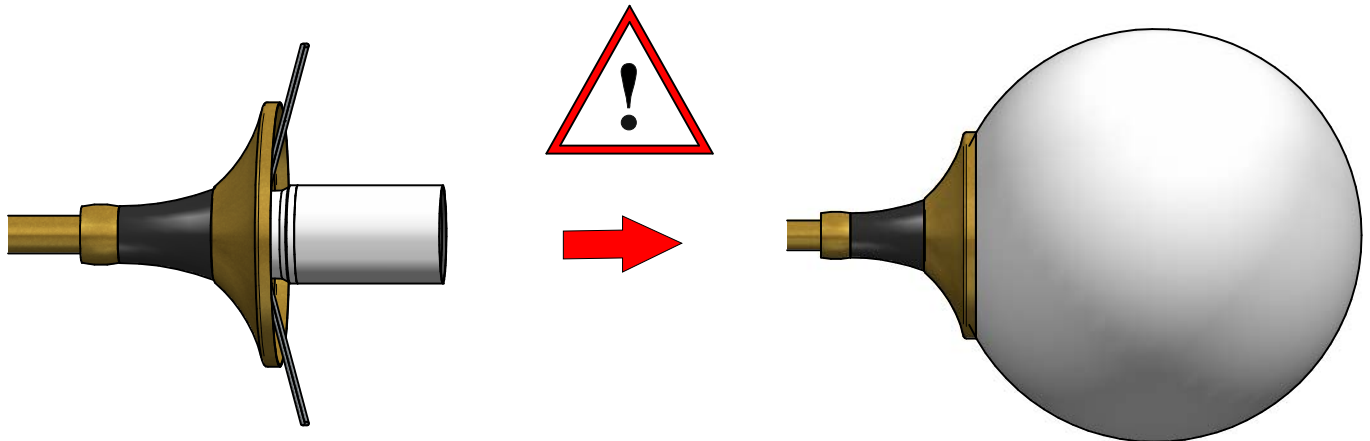

1

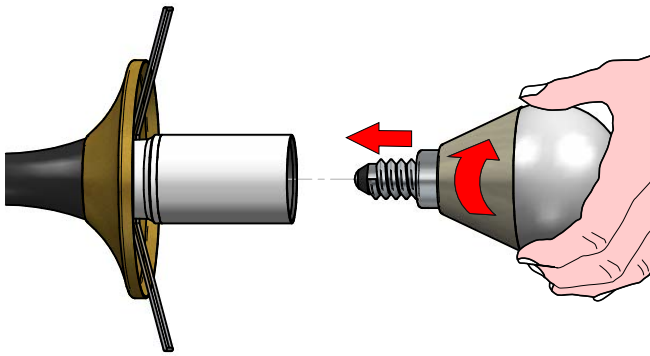

2

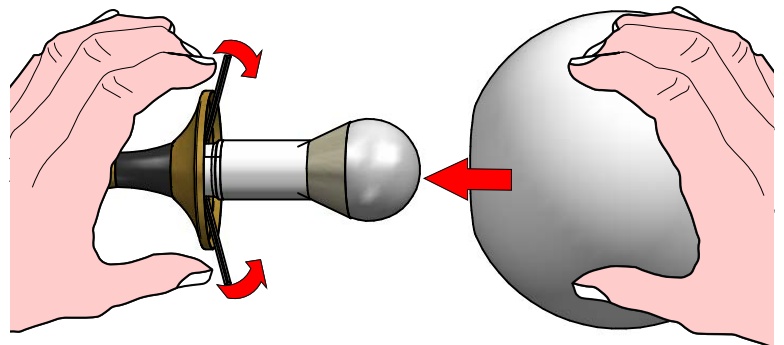

3

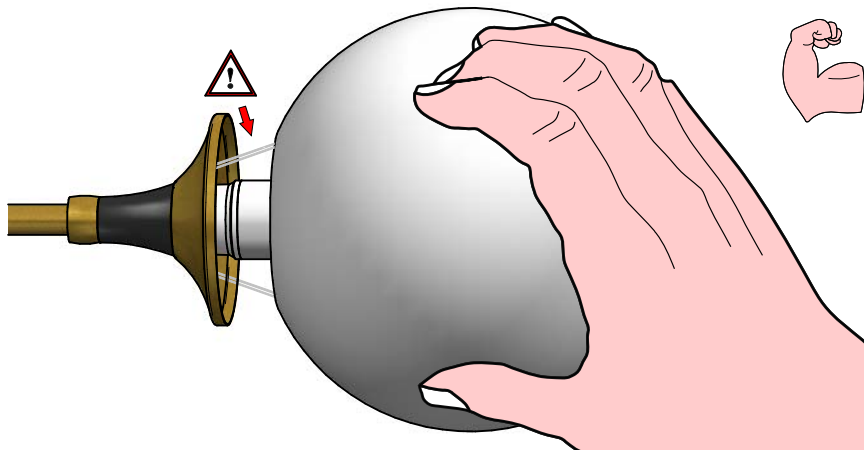

THIS PRODUCT MUST BE INSTALLED IN ACCORDANCE WITH THE APPLICABLE INSTALLATION CODE BY A PERSON FAMILIAR WITH THE CONSTRUCTION AND OPERATION OF THE PRODUCT AND THE HAZARDS INVOLVED

MOUNTING INSTRUCTIONS

READ ALL OF THESE INSTRUCTIONS BEFORE INSTALLING FIXTURES

- Keep all of the instructions for future reference
- Turn off power before installing fixture
- Installation is to be performed by a qualified electrician only
- All installations must conform to the National Electrical Code as well as all local jurisdictional codes and regulations
- Any modification of the luminaire will void any and all written or implied warranties
- The manufacture accepts no responsibility for damage to persons or property arising through improper use or installation



GALASSIA
FLOOR LAMP
FAMILY

■ E9560

**SPARE PARTS**

Reference	Code	Description
1	103000023528	Vetro

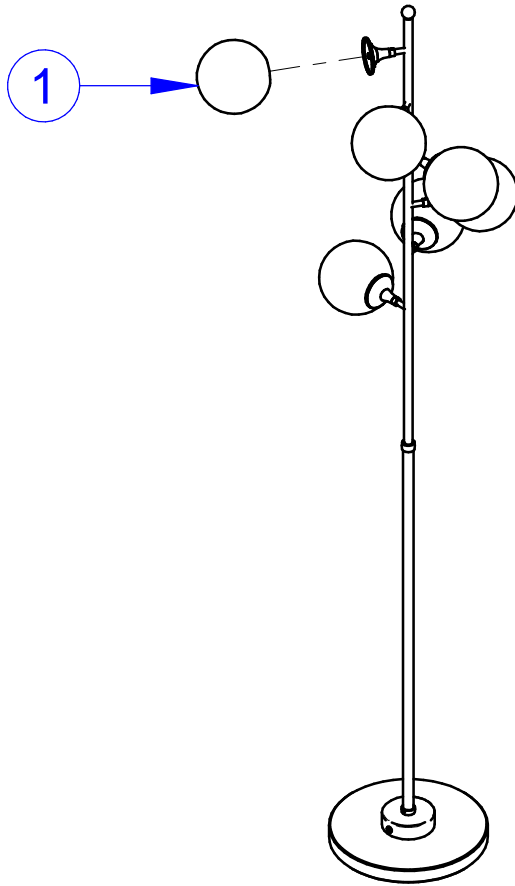

GALASSIA

INSTALLATION INSTRUCTIONS

inter•lux

3741 Commerce Dr. #306-308
Baltimore, MD 21227
Phone (410) 381-1497
inter-lux.com



GALASSIA
FLOOR LAMP
FAMILY

E9560

