



MEGAFONO
 PENDANT
 FAMILY

16x
■ E9566
■ E9567

12x
■ E9568
■ E9569

6x
■ E9576
■ E9577

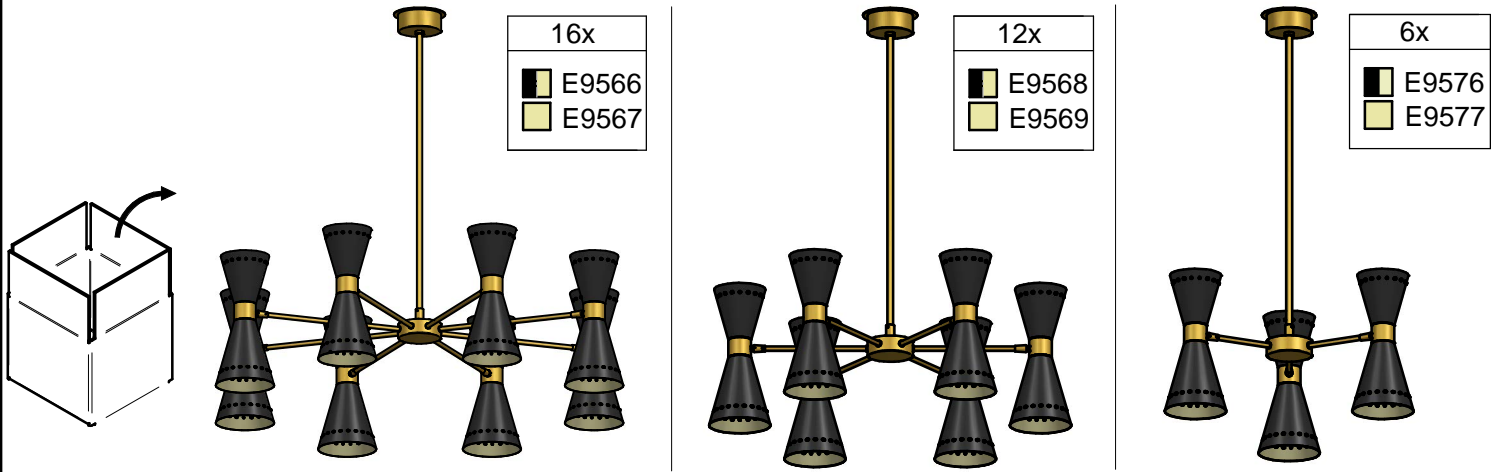

WARNING:
 INSTALL PRODUCT IN ACCORDANCE WITH LOCAL AND NATIONAL ELECTRICAL CODES BY A QUALIFIED ELECTRICIAN

WARNING:
 FAILURE TO COMPLY WITH THE INSTALLATION INSTRUCTIONS MAY RESULT IN DEATH OR SEVERE INJURY.

WARNING:
 READ ALL SAFETY INSTRUCTIONS INCLUDED WITH LUMINAIRE BEFORE INSTALLING LUMINAIRE. SAVE INSTRUCTIONS FOR FUTURE USE.

CAUTION:
 THIS IS AN ELECTRONIC DEVICE. CARE MUST BE TAKEN DURING STORAGE AND HANDLING. STORE IN A CLEAN, COOL AND DRY LOCATION. ELECTROSTATIC DISCHARGE (ESD) CAN HARM THIS PRODUCT. AVOID STATIC DISCHARGE WHILE HANDLING THIS PRODUCT.

CAUTION:
 INTER-LUX IS NOT RESPONSIBLE FOR THE STRUCTURAL INTEGRITY OF THE BUILDING TO SUPPORT THE LUMINAIRE. ADDITIONAL BACKING MAY BE REQUIRED.

LOCATE AND REVIEW ANY CONSTRUCTION PLANS AND INTER-LUX RECORD DRAWINGS FOR ALL FIXTURE RUNS. IT IS RECOMMENDED TO LOCARE AND LAY OUT ALL COMPONENTS FOR EACH FIXTURE "RUN". A FIXTURE RUN TYPICALLY CONSISTS OF JOINERS, LENGHTS OF HOUSING, AND ENDCAPS. BE SURE TO IDENTIFY ALL CORRECT LENGHTS FOR EACH FIXTURE RUN.

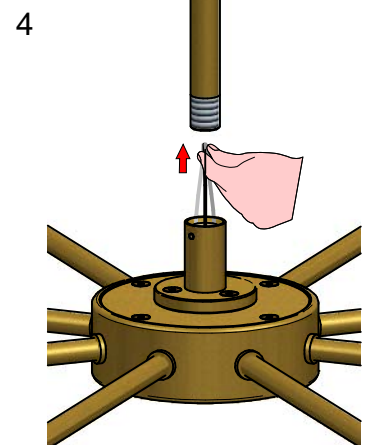
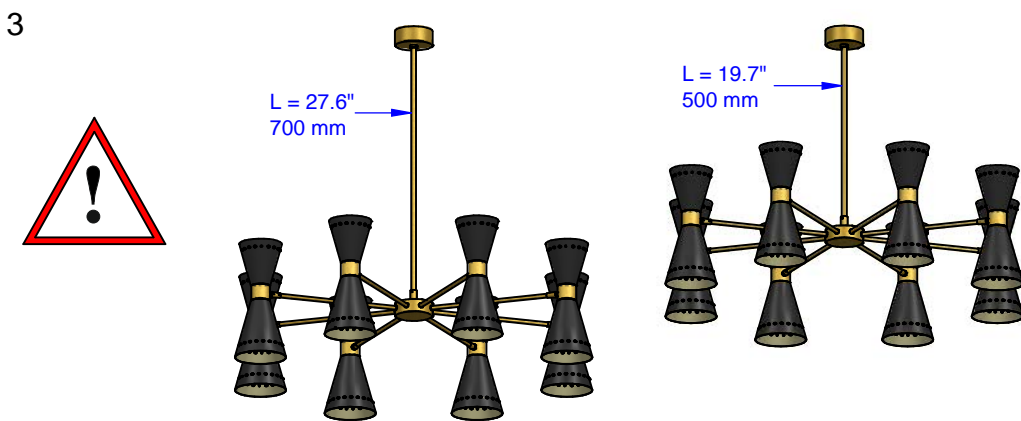
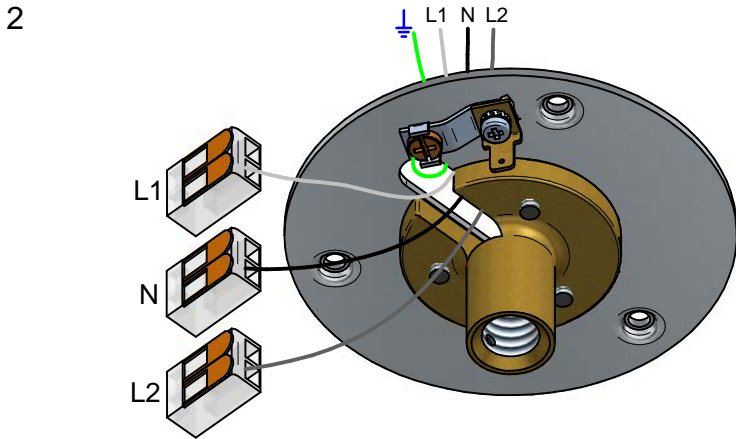
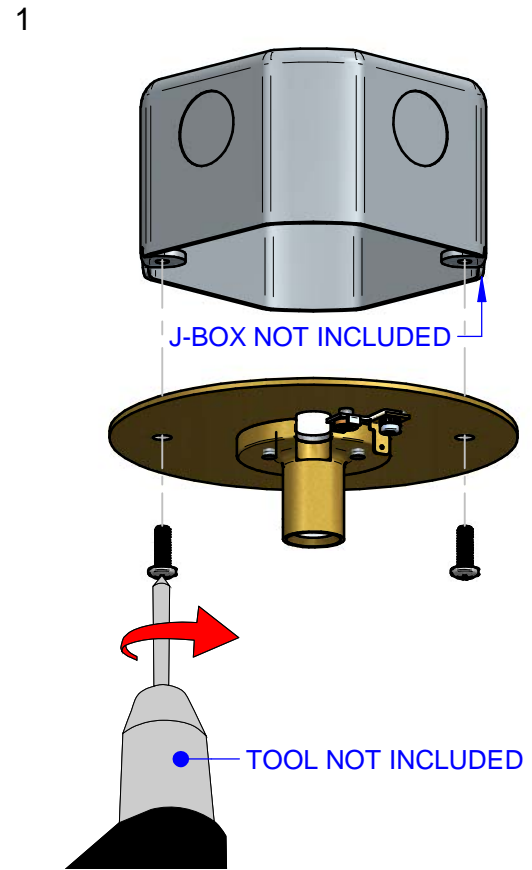

MEGAFONO
PENDANT
FAMILY

16x

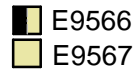

12x

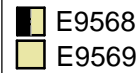

6x

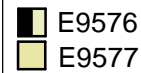

5

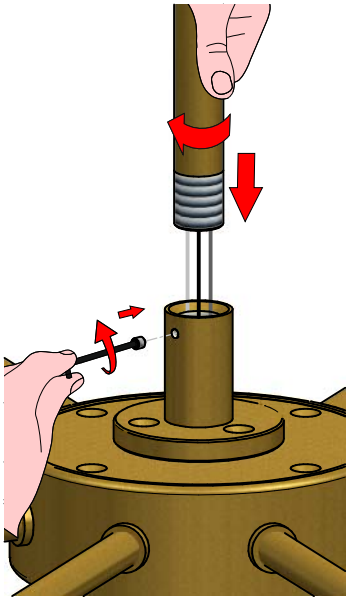

6

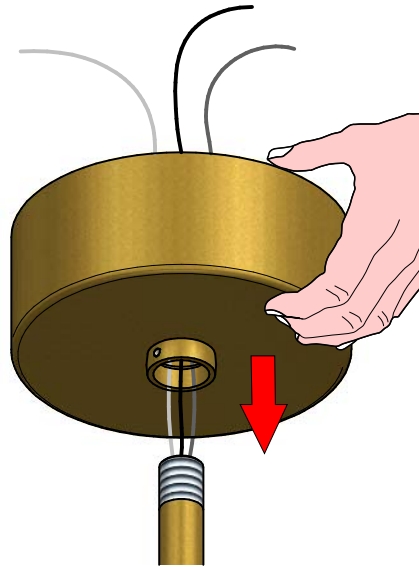

7

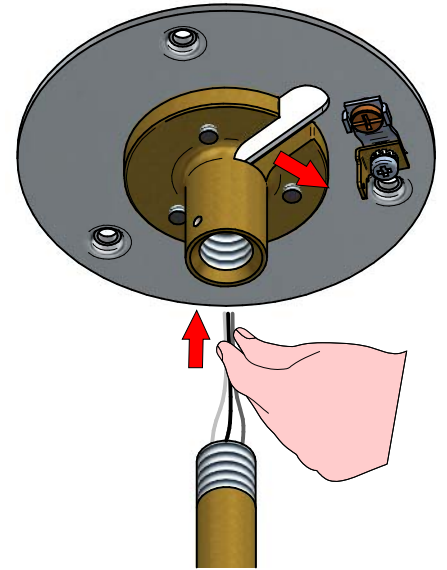

8

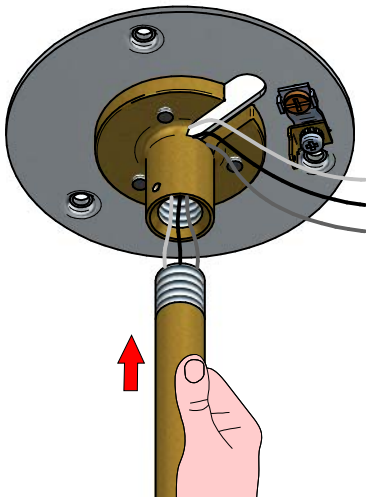

9

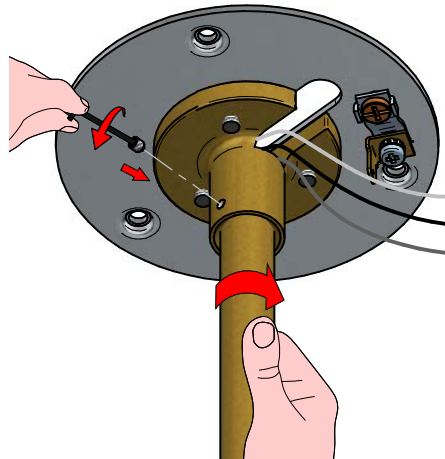

10

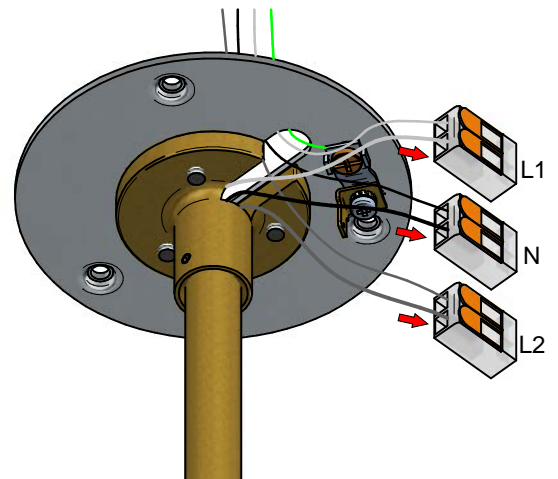

11

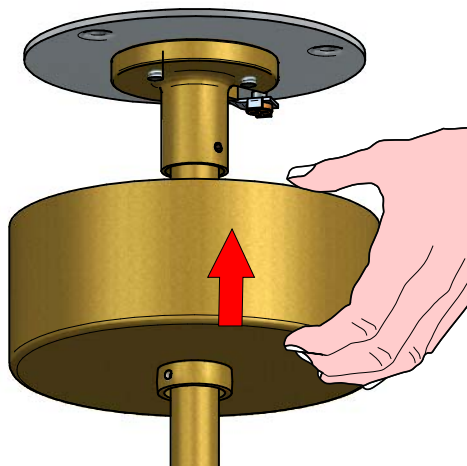

12

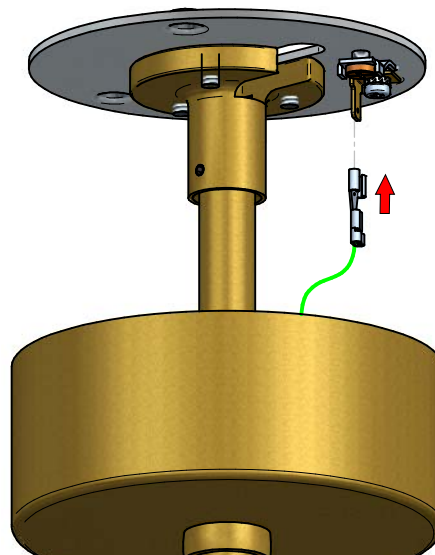

13

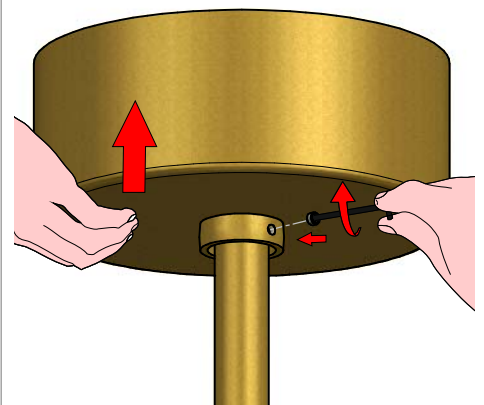

MEGAFONO
PENDANT
FAMILY

16x

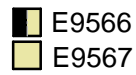

12x

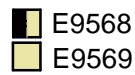

6x

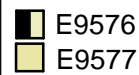
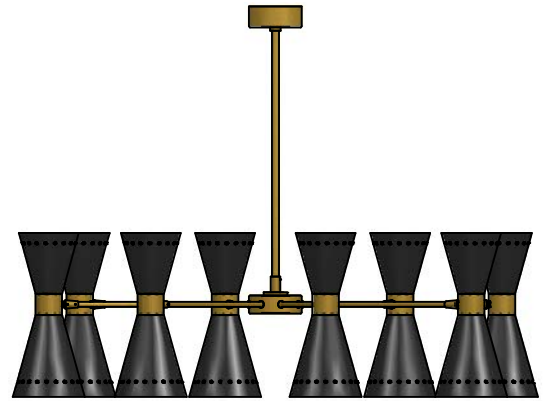
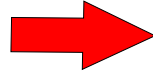
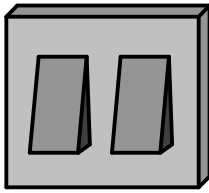
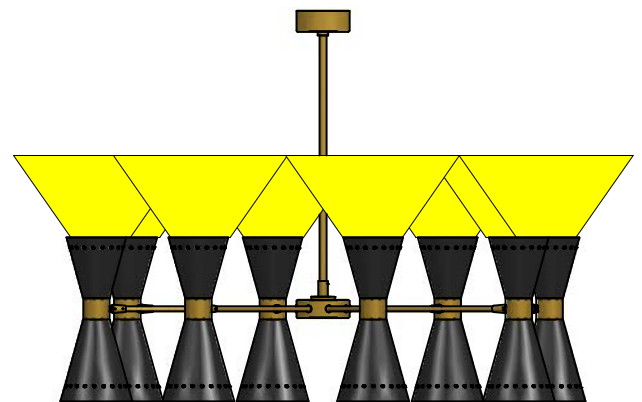
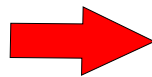
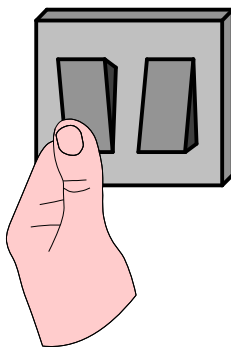
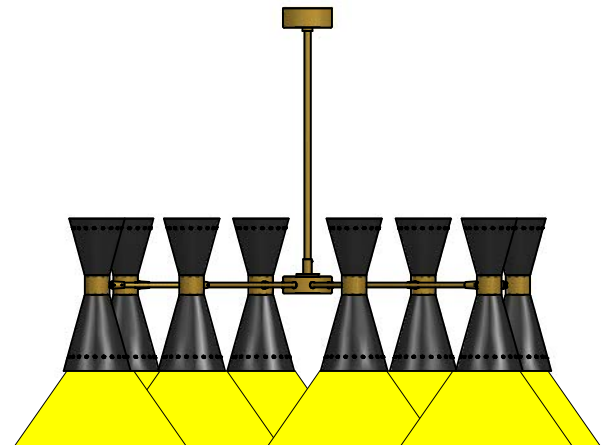
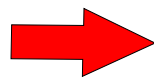
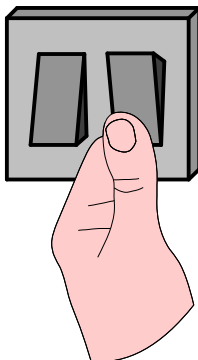
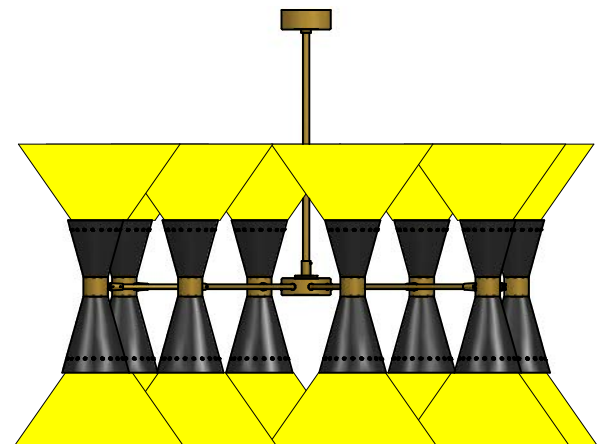
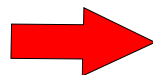
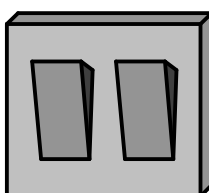
**OFF OFF****ON OFF****OFF ON****ON ON**



MEGAFONO
PENDANT
FAMILY

16x
E9566
E9567

12x
E9568
E9569

6x
E9576
E9577



OFF OFF

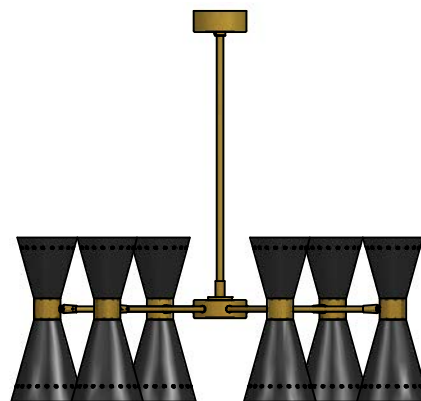
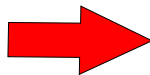
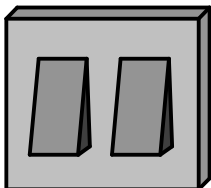

ON OFF

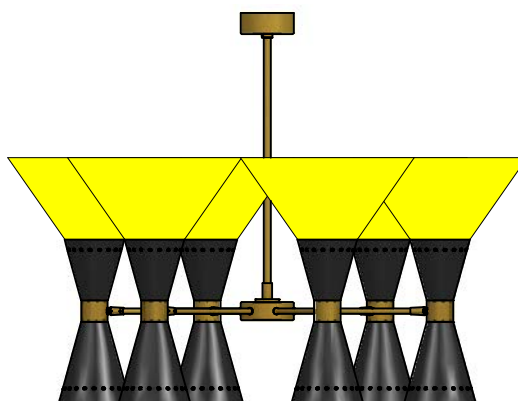
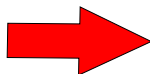
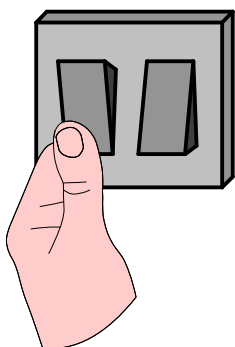

OFF ON

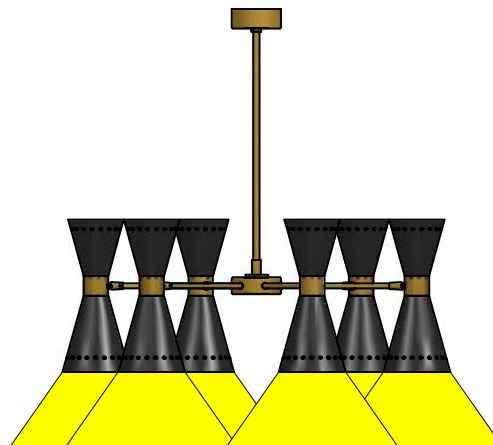
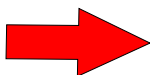
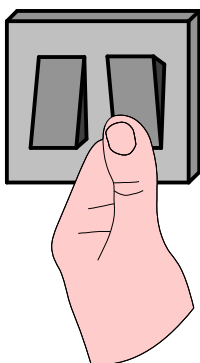

ON ON

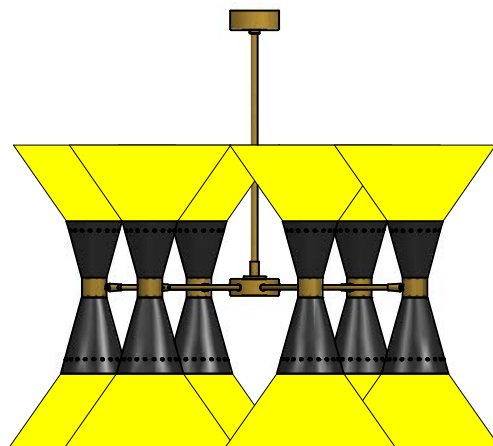
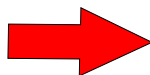
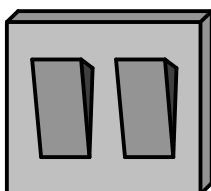

MEGAFONO
PENDANT
FAMILY

16x

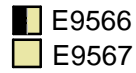

12x

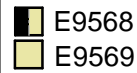

6x

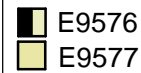
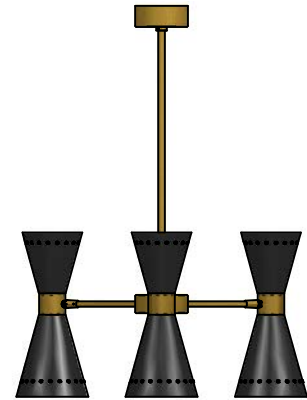
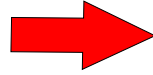
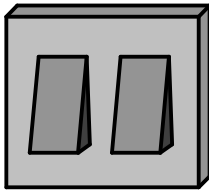
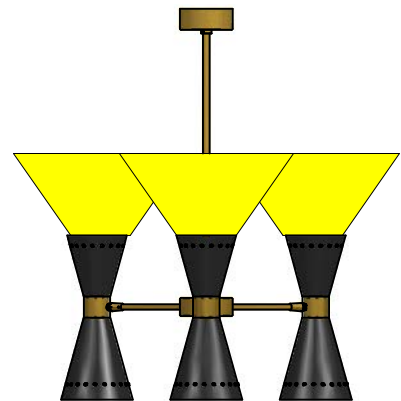
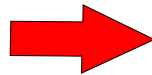
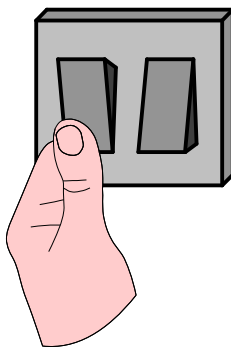
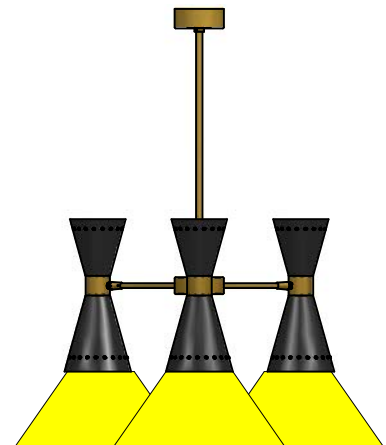
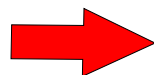
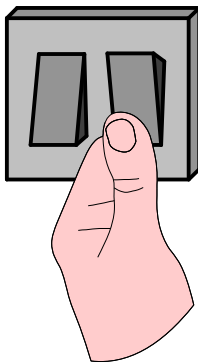
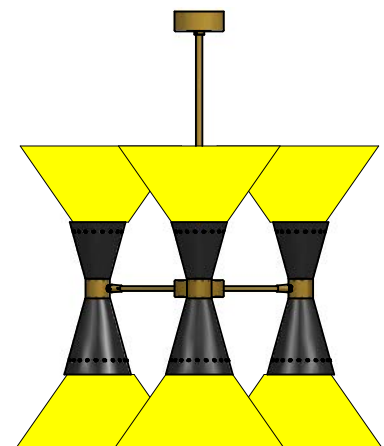
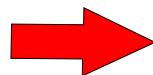
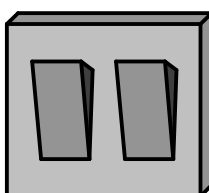
**OFF OFF****ON OFF****OFF ON****ON ON**

MEGAFONO
PENDANT
FAMILY

16x

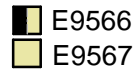

12x

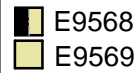

6x

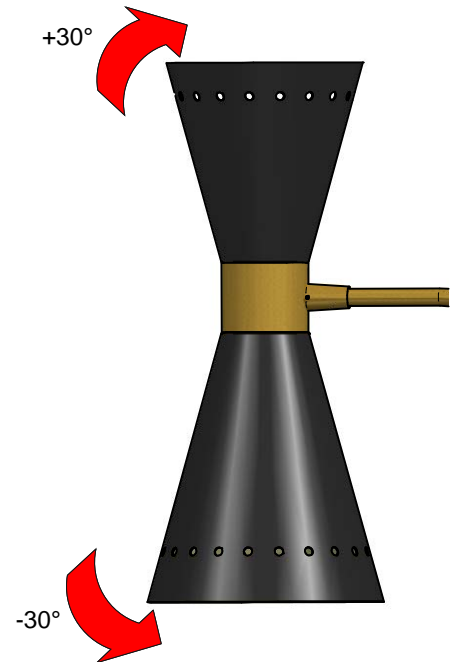
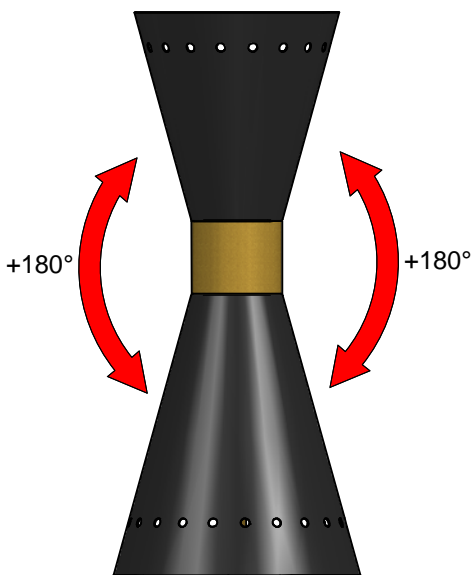
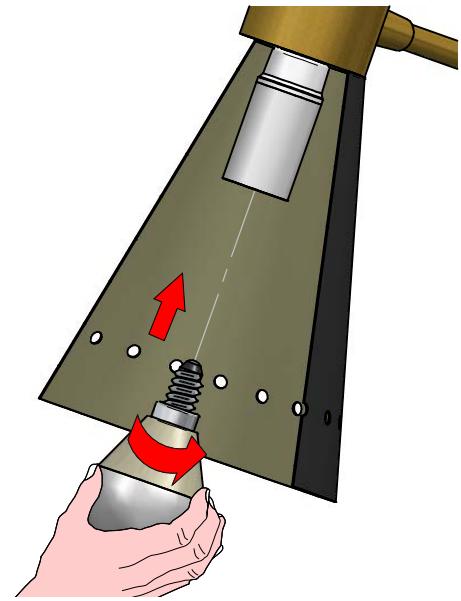
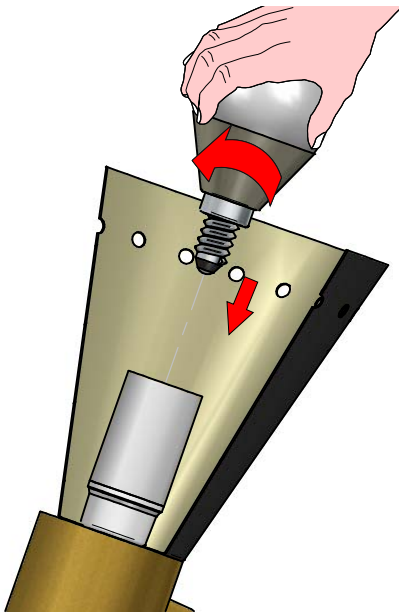
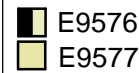

THIS PRODUCT MUST BE INSTALLED IN ACCORDANCE WITH THE APPLICABLE INSTALLATION CODE BY A PERSON FAMILIAR WITH THE CONSTRUCTION AND OPERATION OF THE PRODUCT AND THE HAZARDS INVOLVED

MOUNTING INSTRUCTIONS

READ ALL OF THESE INSTRUCTIONS BEFORE INSTALLING FIXTURES

- Keep all of the instructions for future reference
- Turn off power before installing fixture
- Installation is to be performed by a qualified electrician only
- All installations must conform to the National Electrical Code as well as all local jurisdictional codes and regulations
- Any modification of the luminaire will void any and all written or implied warranties
- The manufacture accepts no responsibility for damage to persons or property arising through improper use or installation

