

Linear



whitegoods





## whitegoods

Whitegoods has developed the most complete range of linear fittings and integration profiles to illuminate any interior space. The Linear range was conceived to apply the right quality and quantity of illumination to the space while minimizing the source of the light and eliminating obtrusive light spill - all while holding true to our brand philosophy:

- Reduction of detail
- Seamless architectural integration
- Logical, modular systems and families of products
- Ease of specification, installation and maintenance





Whitegoods fixtures provide all-round vertical illumination with high angle secondary diffuse light, filling the volume with light, creating visual brightness and visual comfort too. An array of optical accessories and integration profiles further expands the uses to include grazing, cove and perimeter lighting solutions.

# Linear

Whitegoods is a language of light developed to bring illumination to surfaces in the simplest way possible. We believe in 'luminous surfaces and planes of light'.

It is critical to our approach that our luminaires have a minimal visual impact. Their job is to reveal the surfaces around them, while seamlessly integrating with the architectural envelope. Whitegoods offers the discerning specifier a range of lighting tools to facilitate this approach. The Linear range is the most flexible architectural lighting tool developed to allow designers the freedom to work with light in an instinctive way.

Utilizing the small form factor, the range includes a family of profiles all based around the same high performance linear LED technology, developed by Whitegoods specifically for this product line. Coves, coffers, perimeter wash and seamless lines, all beautifully rendered with smooth even light.

This is Whitegoods: this is Linear.

ProTools 60 Linear (2.4") 46

60 Linear Flush Lens (2.4") 78

100 Linear Flush Lens (4") 94





# Contents

## ProTools 60 Linear

2.4"



ProTools 2.4" Linear Downlight Recessed

56



ProTools 2.4" Linear Downlight 6" / 12" Recessed

58



ProTools 2.4" Linear Wall Wash Recessed

60



ProTools 2.4" Linear Wall Graze Recessed

62



ProTools 2.4" Linear Perimeter Recessed

64



ProTools 2.4" Linear Downlight Suspended

66

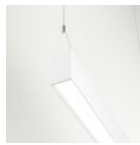

ProTools 2.4" Linear Direct/Indirect Suspended

68



ProTools 2.4" Linear Downlight Surface Mount

70



ProTools 2.4" Linear Downlight 6" / 12" Surface Mount

72



ProTools 2.4" Linear Downlight Wall / Mullion Mount

74

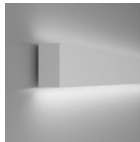

ProTools 2.4" Linear Direct/Indirect Wall / Mullion Mount

76



## 60 Linear Flush Lens

2.4"



2.4" Linear Recessed  
Flush Lens

82



2.4" Linear Suspended  
Flush Lens

84



2.4" Linear Direct/Indirect Suspended  
Flush Lens

86



2.4" Linear Surface  
Flush Lens

88



2.4" Linear Wall Direct or Indirect  
Flush Lens

90



2.4" Linear Wall Direct / Indirect  
Flush Lens

92

## 100 Linear Flush Lens

4"



4" Linear Recessed  
Flush Lens

98



4" Linear Suspended  
Flush Lens

100



4" Linear Surface  
Flush Lens

102





## Linear

Applications include:

- General illumination
- Wall wash
- Wall graze
- Accent lighting
- Direct/indirect lighting
- Perimeter lighting

Recessed, surface, suspended and wall mounted to any surface type.

The ability to utilize the same form and technology throughout any multipurpose space to deliver a cohesive language of light.

Small scale to integrate invisibly into the architecture, close to the surface being illuminated for greater energy efficiency and minimal spill light.

Specifiable in standard and completely tailored lengths to fit any space.

# Introduction

## Application Guide

Whitegoods products are extremely versatile and can be integrated in a multitude of ways. Within this section of the book, you will find examples of a range of luminaires used in varying applications, including examples of the detailing used to achieve them.

## Product Specifications

Within this section, you will find detailed information for all Whitegoods products, including key features, selectable options, critical dimensions, mounting possibilities and aesthetic choices. The information you need to help select the perfect luminaire for your application, without the clutter of every last technical detail. But, we also know that ultimately you and your team will need all the technical details, so we have developed a unique way to access and share detailed product specifications. Have a look at the section below, which explains how it works. It's simple and quick.

## Design Guide

We have provided performance data and characteristics for Whitegoods luminaires, as well as providing expected light levels and typical scenarios based on set parameters. The results are intended as a handy reference to help the specifier plan a project quickly, efficiently and with confidence.

**60 Linear Recessed Flush Lens**

**Options:**

- 1.7. 2.7. 3.7. 4.7. 5.7. 6.7. 7.7. 8.7. 9.7. 10.7. 11.7. 12.7. 13.7. 14.7. 15.7. 16.7. 17.7. 18.7. 19.7. 20.7. 21.7. 22.7. 23.7. 24.7. 25.7. 26.7. 27.7. 28.7. 29.7. 30.7. 31.7. 32.7. 33.7. 34.7. 35.7. 36.7. 37.7. 38.7. 39.7. 40.7. 41.7. 42.7. 43.7. 44.7. 45.7. 46.7. 47.7. 48.7. 49.7. 50.7. 51.7. 52.7. 53.7. 54.7. 55.7. 56.7. 57.7. 58.7. 59.7. 60.7. 61.7. 62.7. 63.7. 64.7. 65.7. 66.7. 67.7. 68.7. 69.7. 70.7. 71.7. 72.7. 73.7. 74.7. 75.7. 76.7. 77.7. 78.7. 79.7. 80.7. 81.7. 82.7. 83.7. 84.7. 85.7. 86.7. 87.7. 88.7. 89.7. 90.7. 91.7. 92.7. 93.7. 94.7. 95.7. 96.7. 97.7. 98.7. 99.7. 100.7.

**Dimensions:**

Option	Length	Width	Depth	Mounting	Color	Finish	Material
001	1200	60	10	10	White	Matte	Aluminum
002	1200	60	10	10	White	Gloss	Aluminum
003	1200	60	10	10	White	Matte	Steel
004	1200	60	10	10	White	Gloss	Steel
005	1200	60	10	10	White	Matte	Stainless Steel
006	1200	60	10	10	White	Gloss	Stainless Steel
007	1200	60	10	10	White	Matte	Brass
008	1200	60	10	10	White	Gloss	Brass
009	1200	60	10	10	White	Matte	Copper
010	1200	60	10	10	White	Gloss	Copper

### Accessing Product Specifications

Whitegoods has developed a unique and innovative way to access product specifications, design guides and photometric files of the products you select. Simply click the technical information button and you will be taken to the product page, where you can view and download technical information.

**ProTools 60 Linear** 2.4" aperture family offers straight runs or configurations for linear downlighting, wall washing, wall grazing and perimeter lighting with ultimate performance, superb glare control, lens / louver options and the Whitegoods attention to integration with surrounding materials.

- Recessed
- Suspended
- Surface
- Wall



**60 Linear** 2.4" aperture flush lens family offers straight runs or configurations for linear downlighting with high-angle illumination, lens options and Whitegoods attention to integration with surrounding materials.

- Recessed
- Suspended
- Surface
- Wall

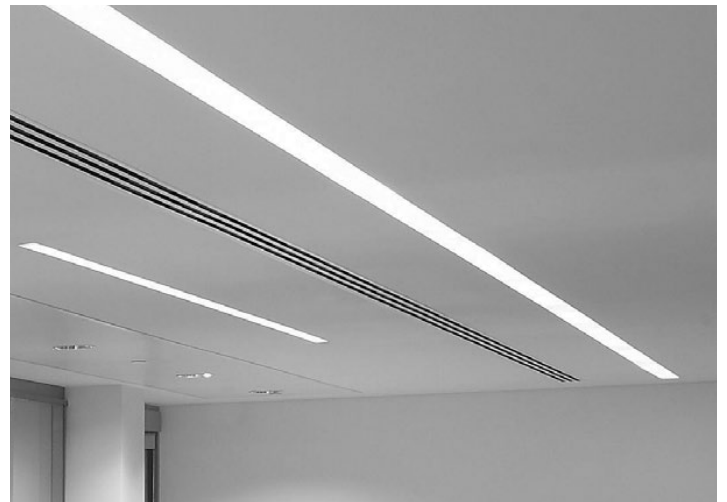

**100 Linear** 4" aperture flush lens family offers straight runs or configurations for linear downlighting with high-angle illumination, lens options and Whitegoods attention to integration with surrounding materials.

- Recessed
- Suspended
- Surface

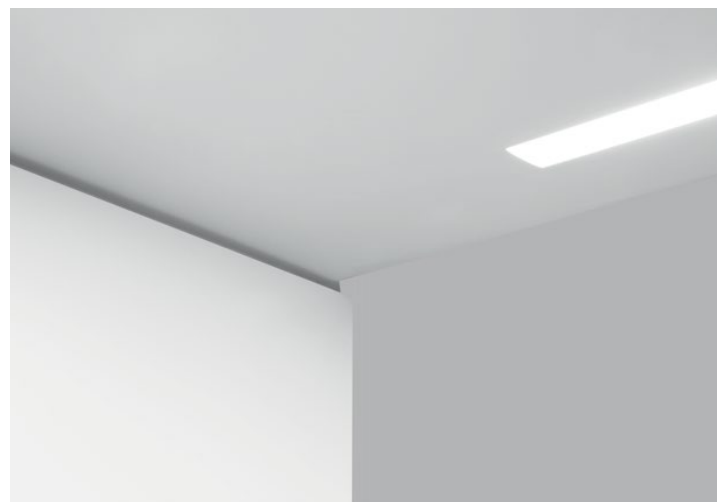

# Linear Modularity

Whitegoods utilizes modularity throughout the range to ensure maximum efficiency of design, manufacture and maintenance. For the specifier this means absolute consistency across all product types and applications, as well as making sense economically.

## 60 / 100 Linear Flush Lens

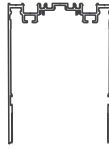

Surface/Recessed Housing



Gear Tray



Diffuser

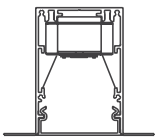

Recessed Plaster Trim

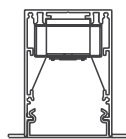

Recessed Bezel/Grid Trim

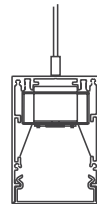

Suspended

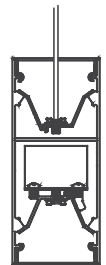

Suspended Direct/Indirect

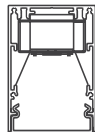

Surface Mount

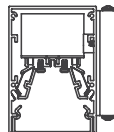

Wall/Mullion Mount

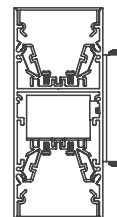

Wall/Mullion Mount Direct/Indirect

ProTools 60 Linear

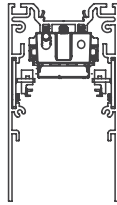

Surface/Recessed Housing

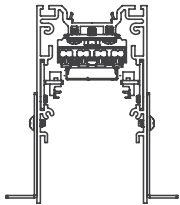

Recessed Plaster Trim

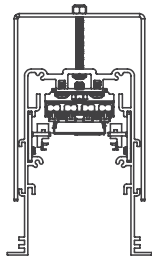

Recessed Bezel Trim

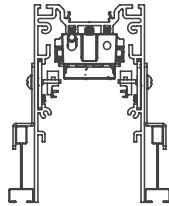

Recessed Grid

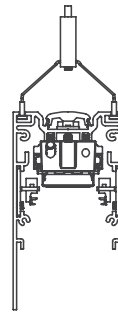

Suspended

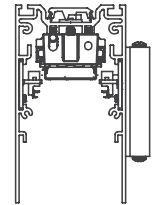

Wall/Mullion Mount

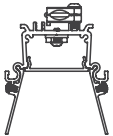

Recessed  
Micro-prismatic Lens

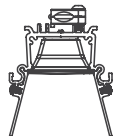

Recessed Louver

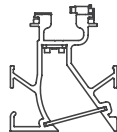

Wall Wash Lens

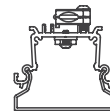

Regressed Opal Lens

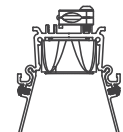

Recessed Narrow Optic

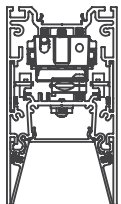

Recessed  
Micro-prismatic Lens

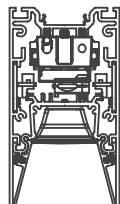

Recessed Louver

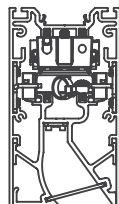

Recessed Lens + Wall Wash

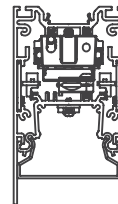

Regressed Opal Lens

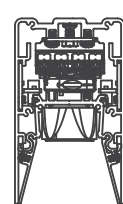

Recessed Narrow Optic





Whitegoods developed a specific LED light source optimized for our linear products, using the highest performance and quality LED devices available on a form factor that best fits our product mechanically and electronically. We use this LED throughout our entire range of 20Linear, Linear, Cove and Perimeter lighting systems. Additionally, we standardize on the highest quality drivers and control devices to ensure that our system works at peak performance and consistency mile after mile.

Whitegoods products are developed in a modular fashion that allows easy repair or replacement of the light source without upsetting the installation. We term this: future proofing.



- Replaceable light source guarantees sustainability.
- Available in any continuous length to accommodate exacting installations.
- Multiple wattages and lumen output for maximum flexibility within any application.
- Constant current, 90+ CRI, 3 step MacAdam.
- Four standard color temperatures from 2700K-4000K + Tunable White (2200K-4000K).
- Compatible with all common dimmer and control standards.
- High efficiency design delivers up to 120 lumens/watt
- L70 (TM21 Projected 85C) 72,000 hours.
- Used throughout Whitegoods 20 Linear, Linear, Cove and Perimeter products for color and performance consistency.
- 5-year warranty.

# Linear System Configuration Logic

Whitegoods Linear systems can be specified to any length and in almost any pattern. Our purpose-designed configuration software determines the exact dimensions required for each and every section. Corners are prefabricated in our factory to keep things simple in the field.

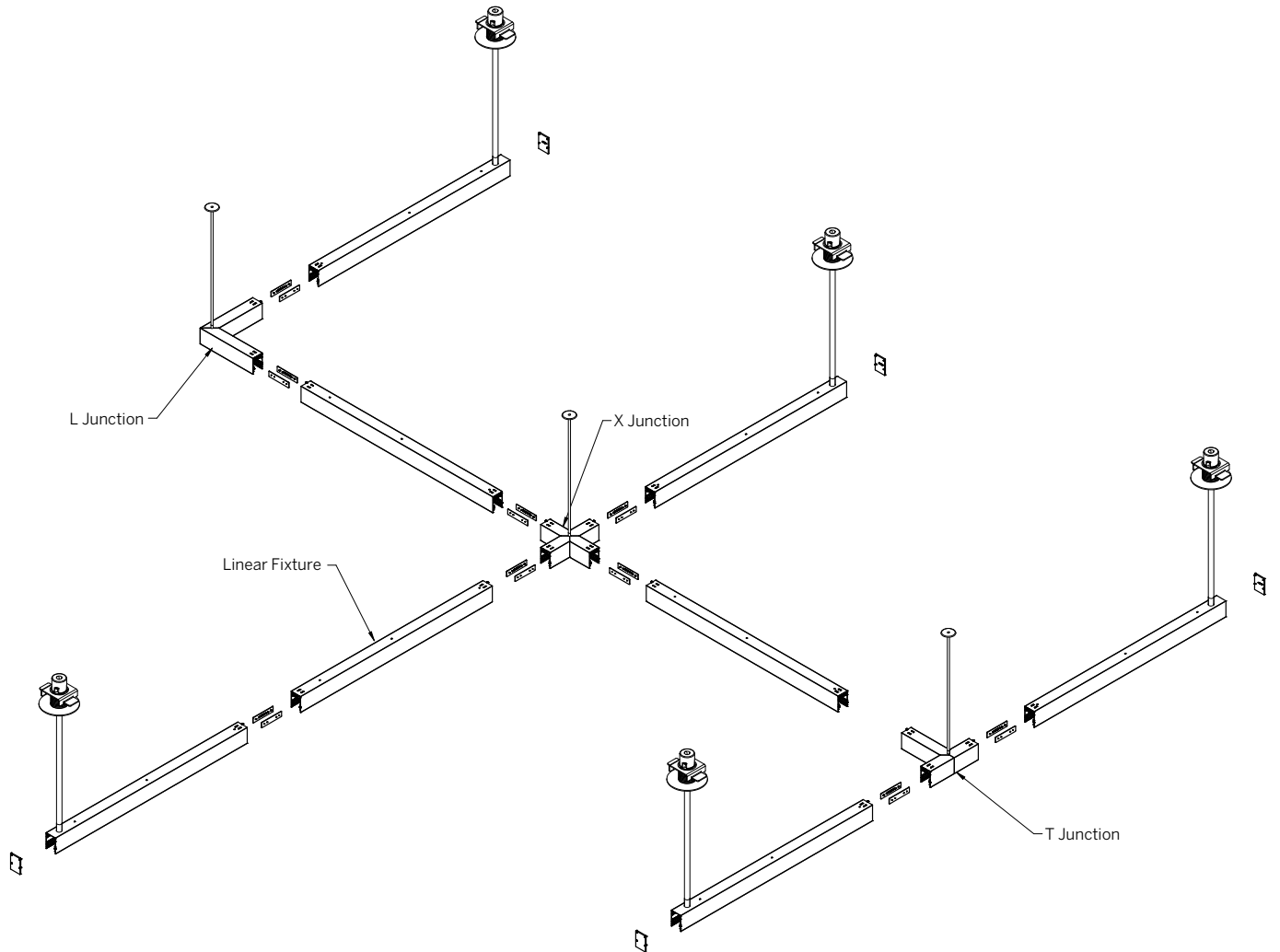





Employee Expenses	Incidents	Claims	Functions	Transactions
100,000	50,000	20,000	10,000	5,000
80,000	40,000	15,000	8,000	4,000
60,000	30,000	12,000	6,000	3,000
40,000	20,000	8,000	4,000	2,000
20,000	10,000	4,000	2,000	1,000



MEMBERS' WALL



# Linear Lenses/Accessories

To further expand the applications that can be successfully achieved with the Linear, Whitegoods continues to develop optical accessories that increase efficiency, tighten the beam spread and shield the light source. The integration profiles available all accommodate optical accessories to allow the designer to combine attributes to successfully satisfy the application at hand.

## Flush Lenses (wide-angle illumination)



Opal Diffuser provides even, continuous line of light and general illumination (OD)



Satin Clear Diffuser for high efficiency soft edge beam, general illumination (SD)



Drop Diffuser of satin acrylic for general illumination and decorative effect (DD)

## Recessed Lenses (multiple distributions and brightness control)



Recessed Micro-prismatic lens - diffusion with maximum efficiency (RML)



Regressed Opal Lens - evenly illuminated line of light (ROL)



Recessed Elliptical Optic - high efficiency graze (REO)



Recessed Louver in white or black - extreme cut-off (RLW/RLB)



Recessed Narrow Optic - narrow beam (RNO)



Linear Micro-prismatic Lens - diffusion and high efficiency (LML)



# Linear Interactive Product Overview

click images to open product pages

## ProTools 60 Linear

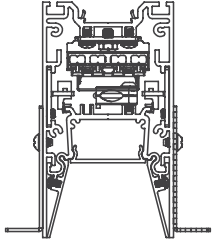

**60PTL-RPT**  
Recessed  
Plaster Trim  
3·5·7·8

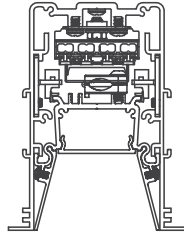

**60PTL-RBT**  
Recessed  
Bezel Trim  
3·5·7·8

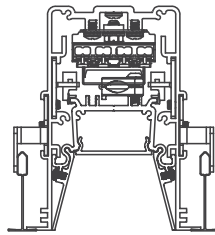

**60PTL-RGT**  
Recessed  
Grid Trim  
3·5·7·8

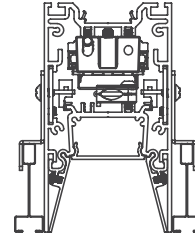

**60PTL-RGTS**  
Recessed  
Slot Grid  
3·5·7·8

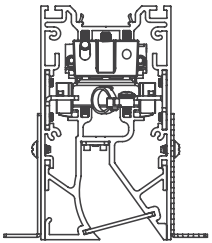

**60PTLWW**  
Recessed  
Wall Wash  
9

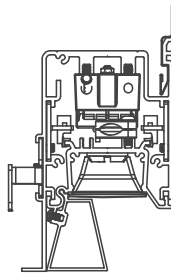

**60PTLWG**  
Recessed  
Wall Graze  
6·7

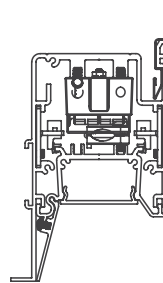

**60PTLP**  
Recessed  
Perimeter  
3·6·7

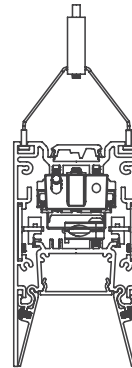

**60PTL**  
Suspended  
3·5·7·8·9

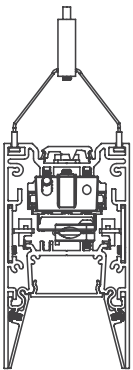

**60PTLDI**  
Suspended  
Direct/Indirect  
3·5·7·8·9

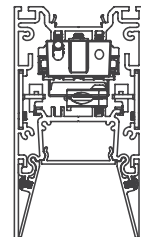

**60PTL-SM**  
Surface Mount  
3·5·7·8·9

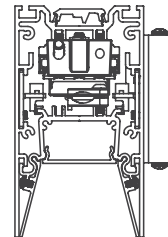

**60PTL-SW/SWM**  
Wall / Mullion Mount  
3·5·6·7

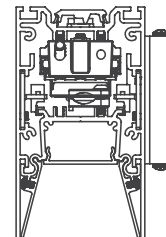

**60PTLDI-SW/SWM**  
Wall / Mullion Mount  
Direct/Indirect  
3·5·6·7

## 60 Linear Flush Lens

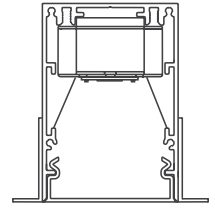

**60LDL-RPT**  
Recessed  
Plaster Trim  
1·4

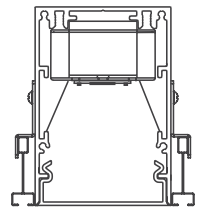

**60LDL-RGTS**  
Recessed  
Slot Grid  
1·4

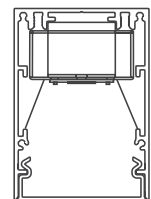

**60LDL-SM**  
Surface Mount  
1·4



1 = Opal Diffuser (OD)



2 = Satin Diffuser (SD)



3 = Recessed Micro-prismatic (RML)



4 = Drop Diffuser (DD)



5 = Regressed Opal Lens (ROL)



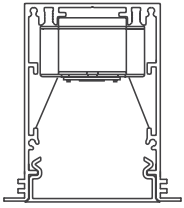

**60LDL-RBT**  
Recessed  
Bezel Trim  
1•4

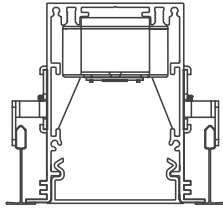

**60LDL-RGT**  
Recessed  
Grid Trim  
1•4

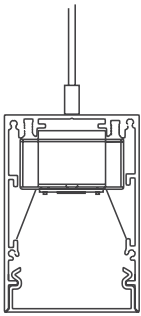

**60LDL-S**  
Suspended  
1•4

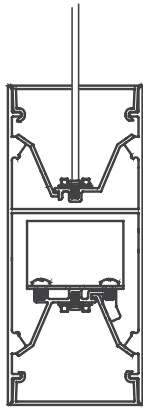

**60LDI**  
Suspended  
Direct / Indirect  
1•2•4

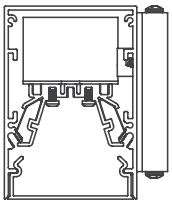

**60LD/LDI-SW/SWM**  
Mullion Mount  
Direct or Indirect  
1•2

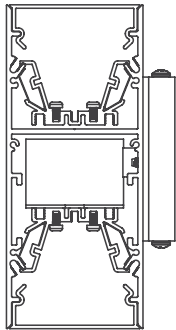

**60LD/LDI-SW/SWM**  
Mullion Mount  
Direct / Indirect  
1•2

### 100 Linear Flush Lens

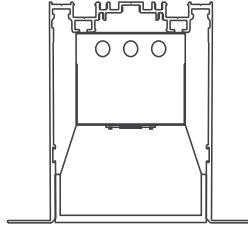

**100LDL-RPT**  
Recessed  
Plaster Trim  
1

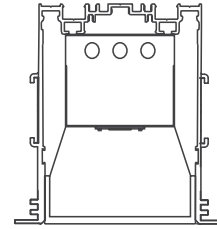

**100LDL-RBT**  
Recessed  
Bezel Trim  
1

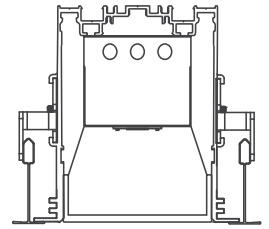

**100LDL-RGT**  
Recessed  
Grid Trim  
1

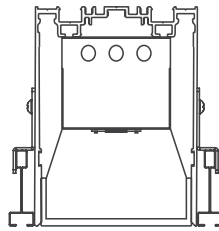

**100LDL-RGTS**  
Recessed  
Slot Grid  
1

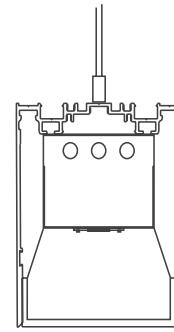

**100LDL**  
Suspended  
1

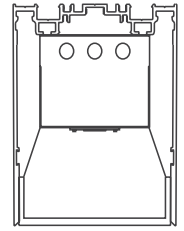

**100LDL-SM**  
Surface Mount  
1



6 = Recessed Elliptical Optic (REO)



7 = Recessed Louver (RLW/RLB)



8 = Recessed Narrow Optic (RNO)



9 = Linear Micro-prismatic (LML)



# Tunable White

Tunable White allows you to select any color temperature between 2200K and 4000K, while maintaining the same high quality color rendering as the standard LED. This feature is often used in health and wellness applications, as well as work spaces to increase productivity, architectural spaces to match natural light, and for design focus in retail and hospitality environments.

Color Temperature	Description	Typical Usage
4000K	Cool	Office, Exterior
3500K	Neutral Cool	Office
3000K	Neutral Warm	Office, Residential
2700K	Warm: Halogen Incandescent	Residential, Hotel
2200K	Very Warm Incandescent	Residential



# RGBW

The ability to add dynamic color-changing to a very small scale product is an exclusive benefit of LED lighting. When used in conjunction with the 60/100 Linear range, colored light can be introduced into the space for accent, health and mood-setting results.





VIA Capital

# Application Guide

Whitegoods Linear products integrate into any space utilizing a multitude of mounting options, and deliver the right illumination where it is intended.

Through the use of multiple optical accessories, Linears are used for many applications including general illumination of a space, wash of light on vertical surfaces, accent lighting on features and grazing of textured surfaces.

Within the Application Guide, we strive to explain the diversity of applications that can be satisfied with Linears by breaking those applications into the most common lighting performance categories.

Integration. Versatility.



ENTER TO LEARN

LEAVE TO SERVE



# Linear Applications

## Downlight

---

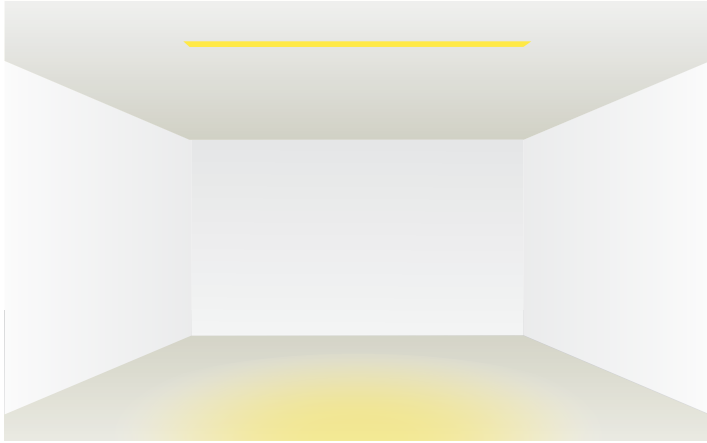

### Regressed Opal Lens

Delivers wide angle general illumination for open spaces such as offices, corridors and classrooms.

### Recessed Micro-prismatic Lens

General illumination with greater brightness control. Spaces where wide angle illumination is required and the source of illumination is not intended as a feature of the space.

### Recessed Louver

This optic delivers narrow to wide angle illumination and a deep recessed louver that eliminates any direct source of brightness. Most applicable for spaces where the object to be illuminated is intended to be the most visible object in the space.

### Flush Opal Lens

Performance includes the highest angle illumination perpendicular to the length of the luminaire while delivering even illumination to the space.

### Flush Microprismatic Lens

Also delivering high angle as well as general illumination, this specially designed lens reduces visual brightness while increasing overall luminaire efficiency.

### Mounting Options

- Recessed in any ceiling type
- Surface mounted
- Suspended
- Wall mounted
- Perimeter mounting

## Wall Wash

---

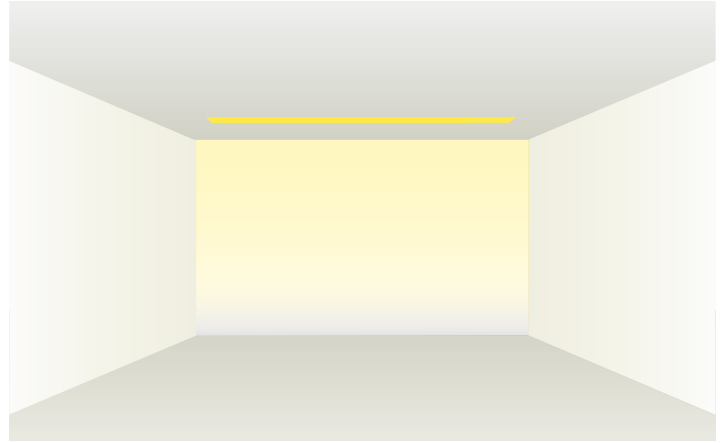

### Linear Wallwash Optic

Spaced appropriately from the wall, accent levels of light are evenly distributed on the subject wall. The wallwash optic delivers light from the very top of the wall, starting with a soft blend of light, to the bottom of the wall evenly, with the maximum light levels found in the mid-wall visual zone. By minimizing the aperture of the luminaire, all brightness from normal viewing angles is eliminated. And with the use of a room-side kicker reflector, all of the light is distributed on the wall without light trespass on the room side. This is all accomplished with a flush to the ceiling plane aperture - the Whitegoods way

### Flush Opal or Micro-prismatic Lens

Often accent levels of light are not needed for a balanced scheme that includes illuminating vertical surfaces. In that case, flush lens Linear will deliver even illumination to adjacent walls by virtue of their soft, high-angle light distribution.

### Mounting Options

- Recessed in any ceiling type
- Surface mounted
- Suspended



## Wall Graze

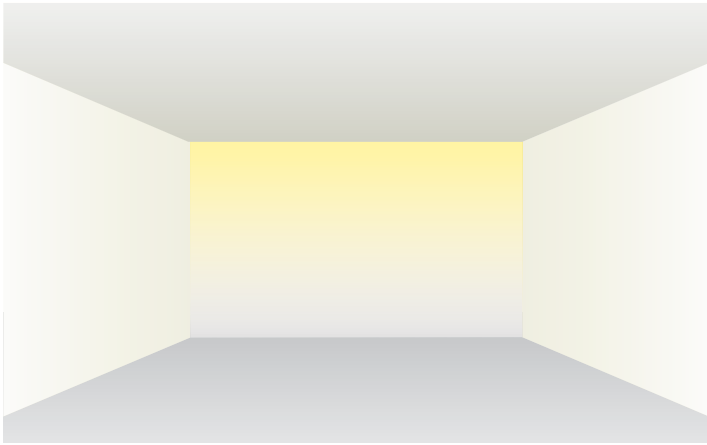

### Perimeter Application

Recessing a continuous linear luminaire at the perimeter of a space is an effective way to provide vertical illuminance that will increase the perceived brightness of the space. The wall side flange of the fixture is removed which allows the wall to continue past the ceiling plane, seemingly to infinity.

### Recessed Louver

By adding a tighter beam of light to the wall graze distribution, light is driven further down the wall and delivers a sheet of light from above the finished ceiling to the base of the wall. The recessed louver cuts viewing angles to the light source when viewed from any angle, and the choice of low or no brightness finishes on the wall-side reflector ensures that the wall is the brightest object in the space.

### Soft-Graze

This feature simply extends the optic further from the wall and softens the contrast effect on the wall. All texture or imperfections of the wall will be less noticeable while you still have the option of using this fine grazing light.

### Recessed Elliptical Optic

The recessed elliptical optic has a very similar light distribution to that of the Recessed Louver versions but will provide 30% more lumens to allow for use in taller ceiling height applications.

### Mounting Options

- Recessed in any ceiling type
- Perimeter mounting

## Perimeter

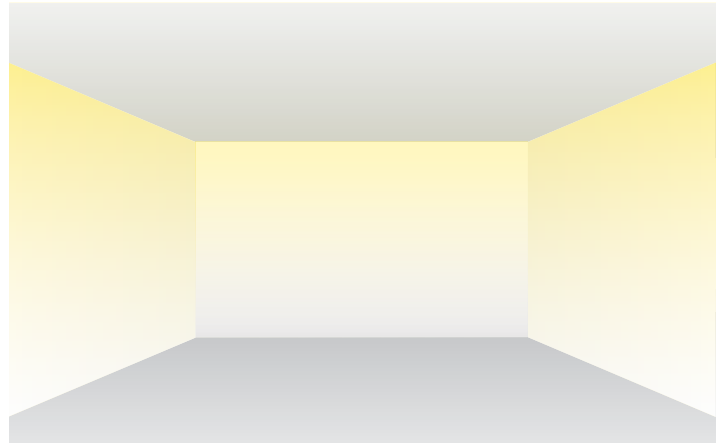

### Recessed Micro-prismatic Lens

A continuous perimeter lighting system that delivers an even wash of light at the top of the wall, from above the finished ceiling, and gradually diminishes closer to the floor. The Perimeter system can be used to illuminate corridors and provide definition to feature walls.

### Recessed Louver

Adding narrow beam optics and a deeply recessed louver in the perimeter system can deliver high levels of light to accent a wall feature up to 30 feet high, and illuminate objects below such as furniture or plant walls, while minimizing glare.

### Soft-Graze

This feature simply extends the optic further from the wall, softens the contrast effect on the wall and projects more light to horizontal surfaces and features on the floor below. In addition, it can compensate for feature wall thickness and put the light exactly where it is needed.

### Mounting Options

- Recessed in any ceiling type
- Perimeter mounting

## Indirect

---

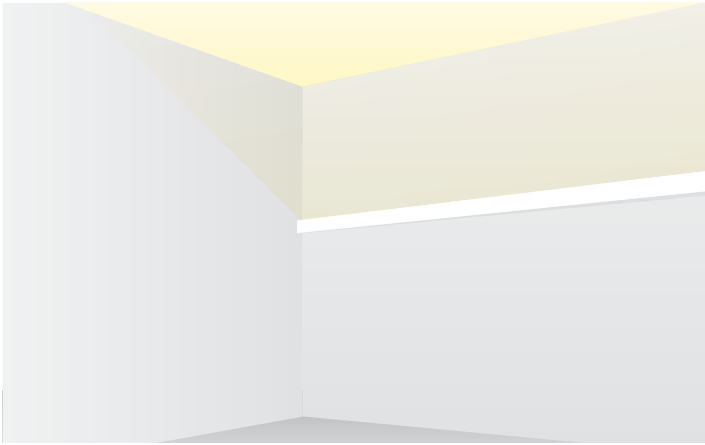

### Batwing

ProTools 60 Linear uplight optics are accomplished through high efficiency refractor lenses specially designed for our LED boards. The Batwing is the wide angle lens that also delivers an even level of light directly above the luminaire. Use this lens when you are as close to the ceiling as 6 inches, use low power LED and still get light out into the space. Typical distances from the ceiling would be 12 inches and more for higher light output.

### Asymmetric

The asymmetric lens is used to direct the majority of the light to one direction. Using this uplight option in a wall mount luminaire will put much less light on the wall and more into the space being illuminated.

### Diffuse Opal Lens or Clear Satin

In applications where the luminaire may be viewed from above, or the application simply calls for general, diffuse illumination, an opal or clear satin lens will obscure the LED pattern and deliver diffuse light to the surface above.

### Mounting Options

- Suspended
- Wall Mount

## Direct/Indirect

---

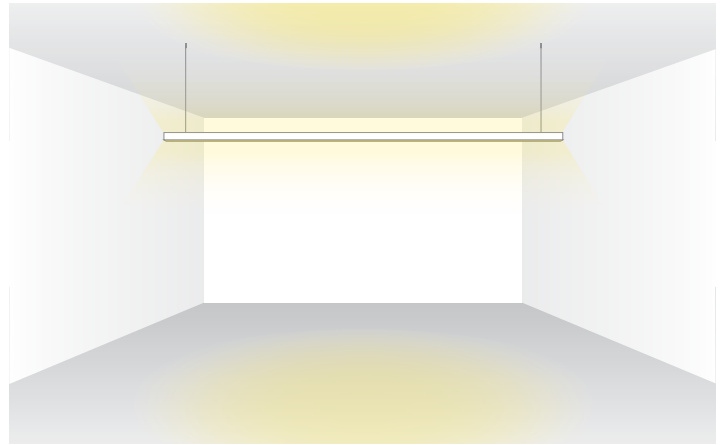

### Direct Light

The downlight component of any Direct/Indirect luminaire utilizes the same optical inserts, thus the same optics as previously referenced under: Downlight.

### Indirect Light

The uplight component of any Direct/Indirect luminaire utilizes the same optical inserts, thus the same optics as previously referenced under: Indirect.

### Mounting Options

- Suspended
- Wall Mount

## Configurations

---

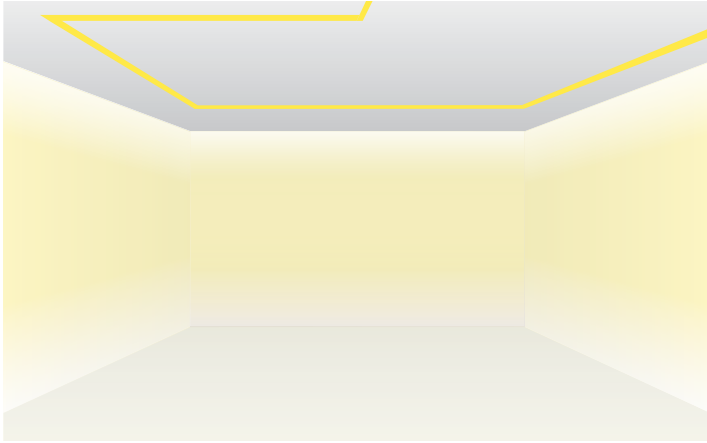

### Configurations

All Linear products are capable of being combined to produce continuous runs of any length. Our Housings can be produced to exact dimensions, the illuminated lenses (Regressed and Recessed) can fill the entire housing with light. Only the Recessed Louver has practical length limitations and cannot accommodate any length - so the LED/louver is provided in 6 inch increments and the difference is filled with a recessed snap-in cover and evenly applied to both ends of a run. Of course we can customize that. We provide corners in 90 degree standard as well as custom. In the same plane, or in two planes such as wall-to-ceiling and wall-to-wall.

Standard or Tailored - the Whitegoods way.

### Mounting Options

- Recessed
- Surface Mount
- Suspended
- Wall Mount
- Perimeter

## Combinations

---



### Combinations

Some applications call for multiple light distributions within a continuous channel. ProTools 60 Linear has been designed in such a modular fashion, so we can populate the housings with different optical inserts - even in a single luminaire or run of multiple luminaires. As long as you specify in minimum 24 inch lengths, we can accommodate your space with a multiple function linear solution.

A Combination is appropriate in spaces where a clean, low brightness, continuous appearance in combination with different lighting applications are required, such as retail, conference rooms and lobbies.

Modularity and Flexibility. Challenge us..

### Mounting Options

- Recessed
- Surface Mount
- Suspended
- Wall Mount



SPINY DOG

Coffee

# FISH CAFÉ

Two vending machines are positioned against the wall. The one on the left is labeled 'hello Goodness' and contains various bottled beverages. The one on the right contains packaged snacks. A man in a green polo shirt is sitting on an orange armchair, talking on a mobile phone.





# Integration

**Balancing the** natural light within the space, continuous linear recessed luminaires are mounted directly opposite the clerestory north lights. As daylight fades the luminaires fade in to provide enough ambient light to the gallery space. The light in effect still comes from the same position, mimicking the natural light effect.

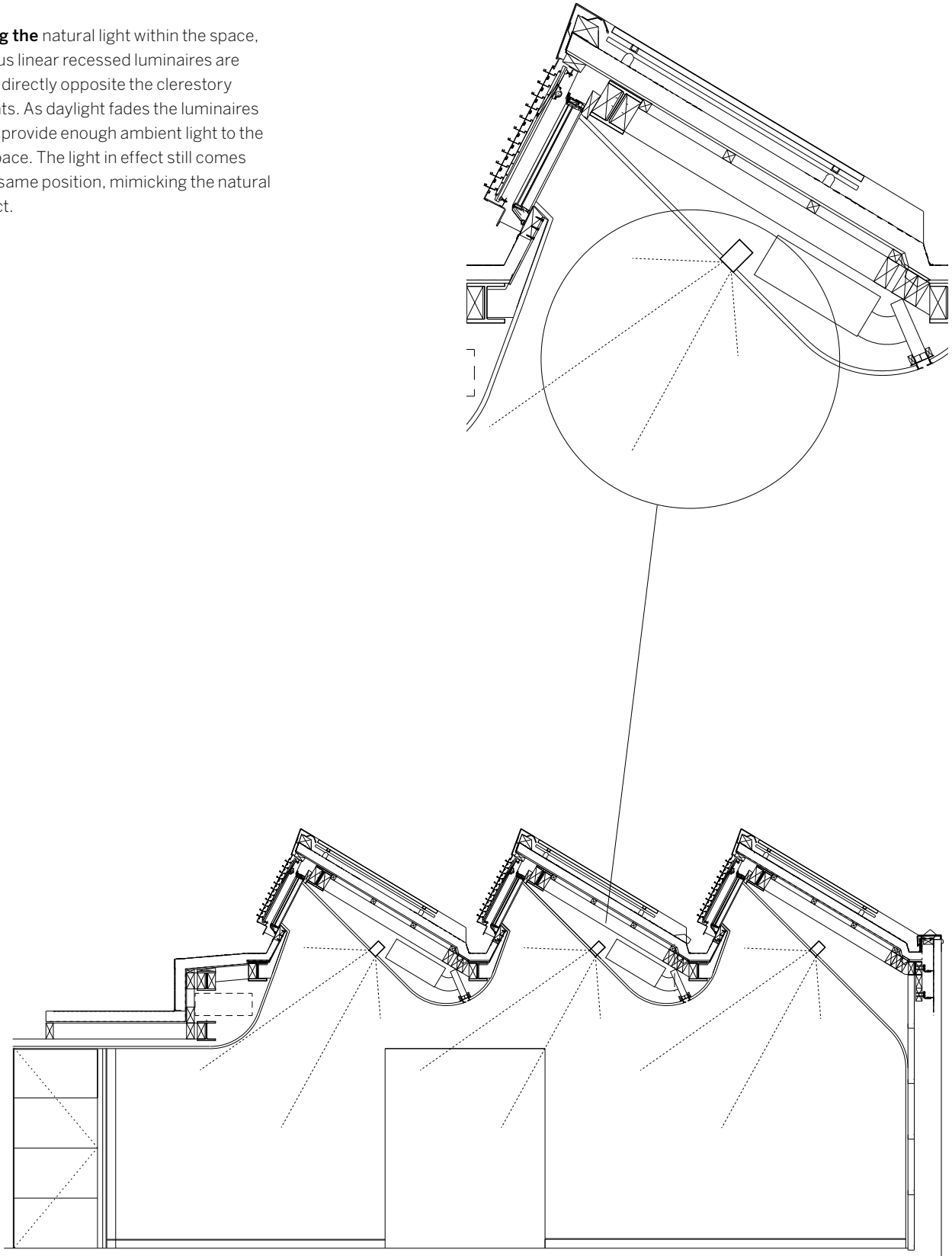

# Suspended Configurations

Linear configurations can take many shapes, sizes and patterns. Designed for nearly any mounting option, coupled with unlimited length and corner possibilities, the designer's only limitation is the space where the product will live.

Here overlapping rectangles are suspended to illuminate a reading space day and night through a combination of direct and indirect light set to appropriate levels and maintained by an ambient light sensor attached to the control gear. Additionally, the system is designed to provide a portion of the required light levels for the feature grow wall.

The system is mechanically held together by active tension cross joiners that apply constant force to fixture connections eliminating light leak. The suspensions are located most anywhere along the system to minimize the clutter and afford the designer maximum freedom.

Modularity + Flexibility + Design

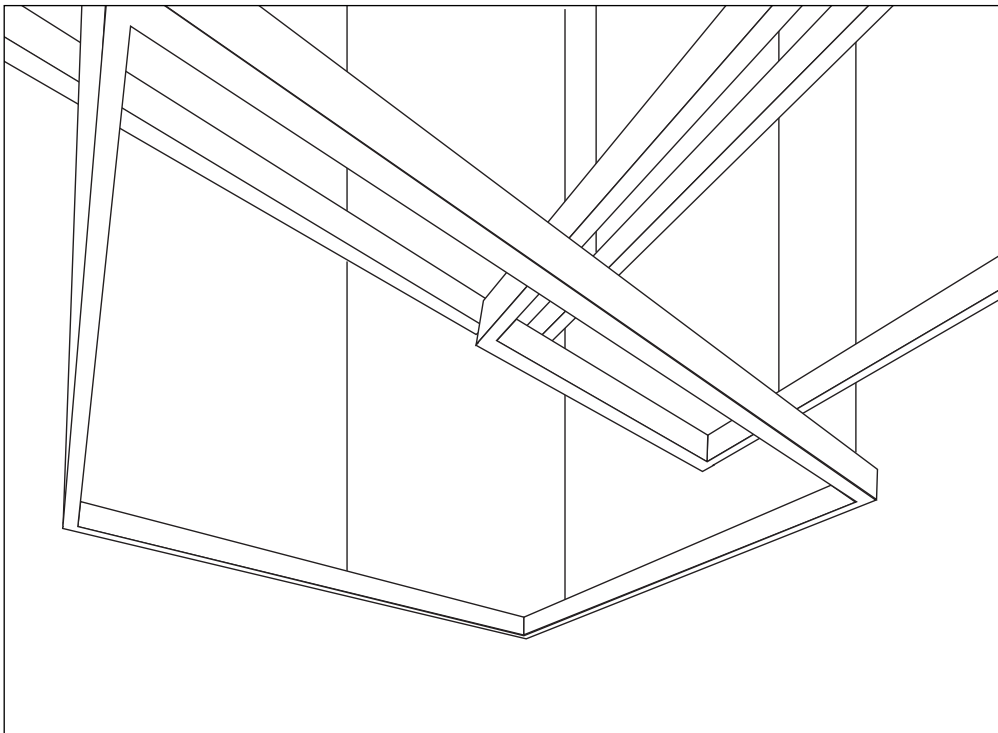







# Clear Span Solution

**Balancing the** natural light within the space, continuous linear surface mounted luminaires are mounted directly beneath the skylights. As daylight fades the luminaires fade in to provide enough ambient light to the library space. The light in effect still comes from the same position, mimicking the natural light effect.

Without a solid ceiling above to anchor the fixture runs, a stiffener was developed to maintain rigidity across the clear-span. And the standard end-wall detail was applied to provide mechanical and electrical service to the system.

WOW

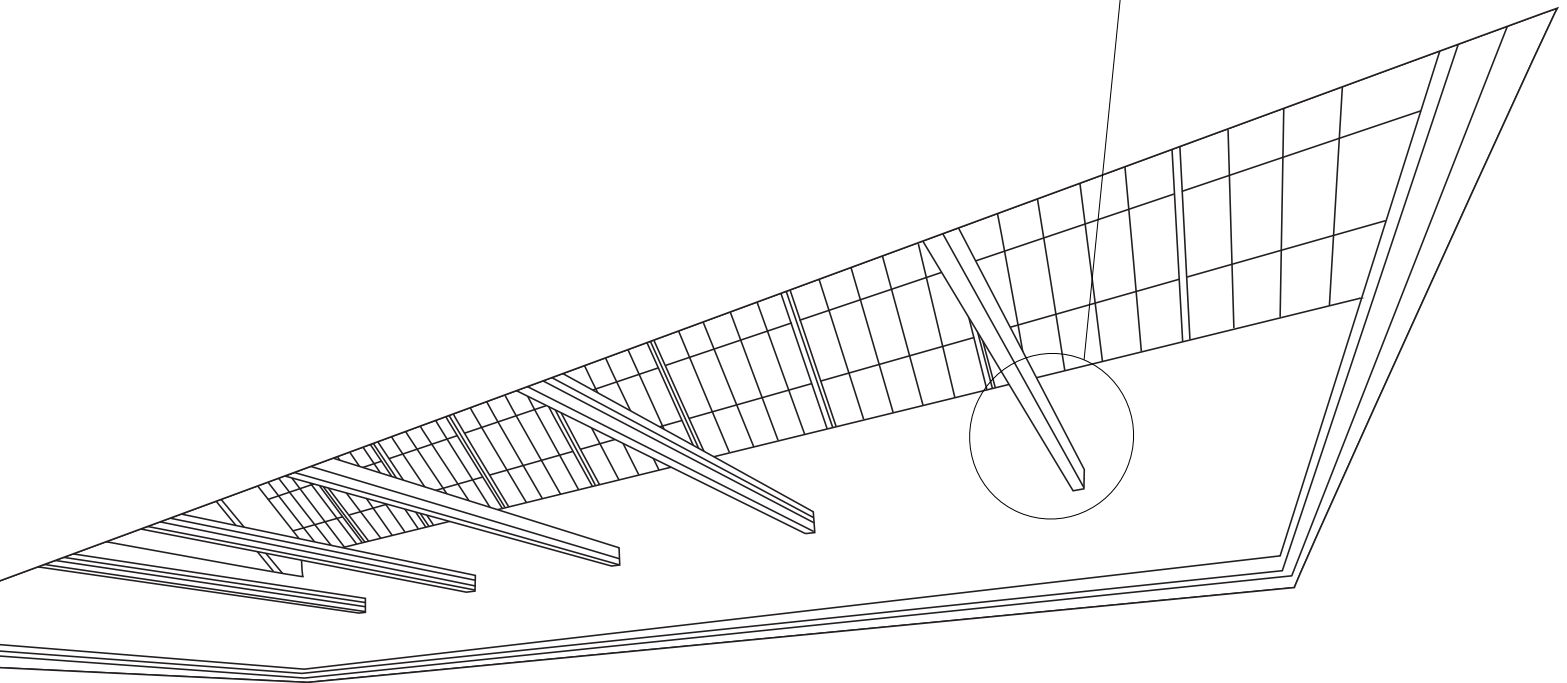
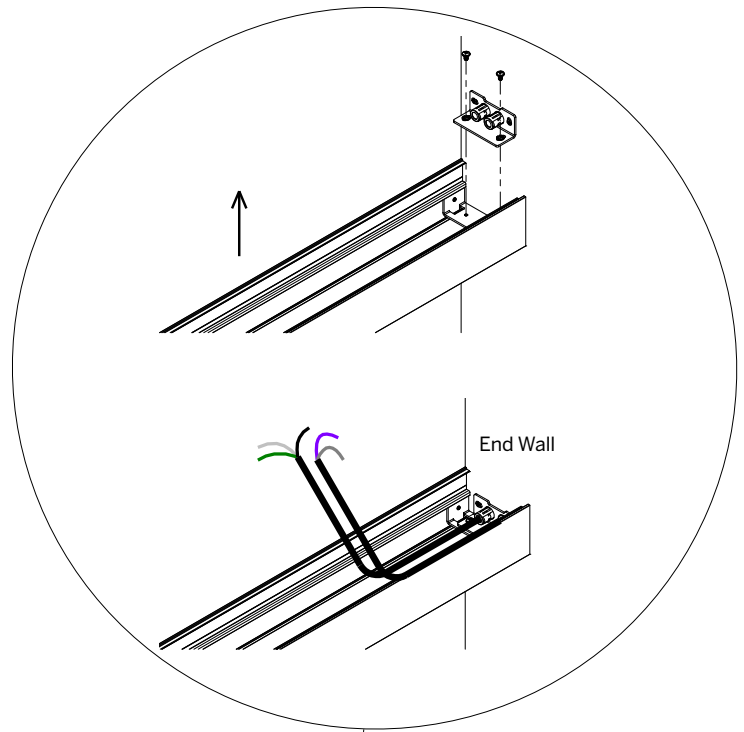



# Recessed Configurations

Whitegoods products have been designed to be 'tailored' to suit the needs of architects and designers seeking to use light as an integrated architectural element.

In this case, our 100 Linear luminaire (100LDL) has been integrated into a wood finish wall paneling system, and then transitions seamlessly via a factory prefabricated corner section into a gypsum ceiling surface. As if this were not enough, the luminaire is completely trimless by way of the Plaster Trim. The lens is continuous and evenly illuminated with no shadows or gaps apparent to the viewer, who perceives only the light, rather than the luminaires used to deliver it.

Whitegoods: Reduction of detail, and seamless architectural integration.

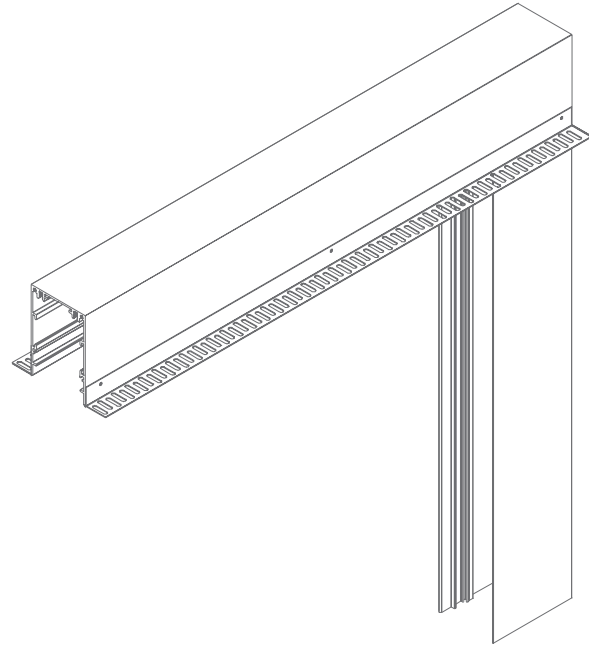

Section View of Ceiling Integration

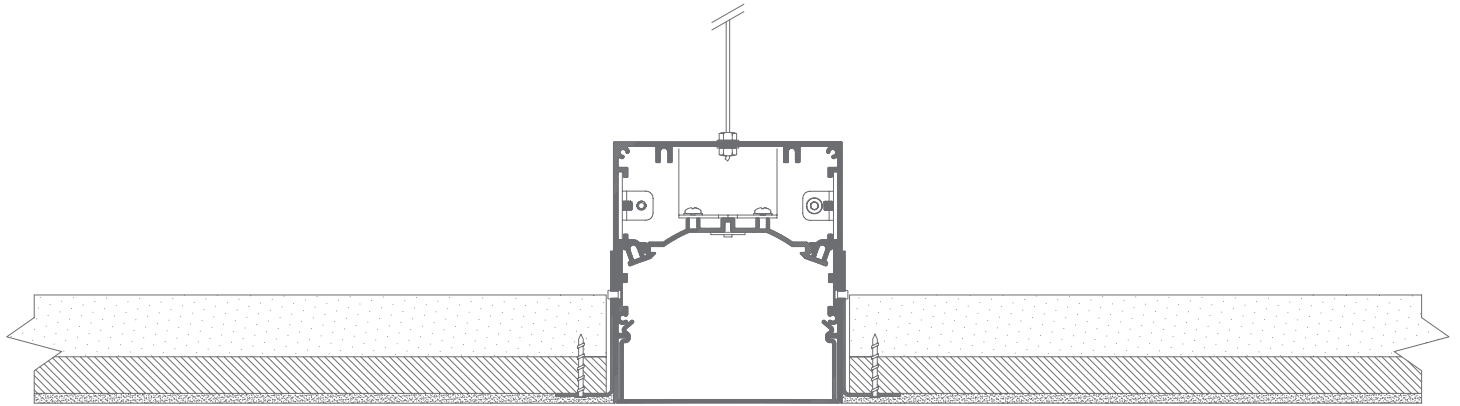

Plan View of Wall System Integration

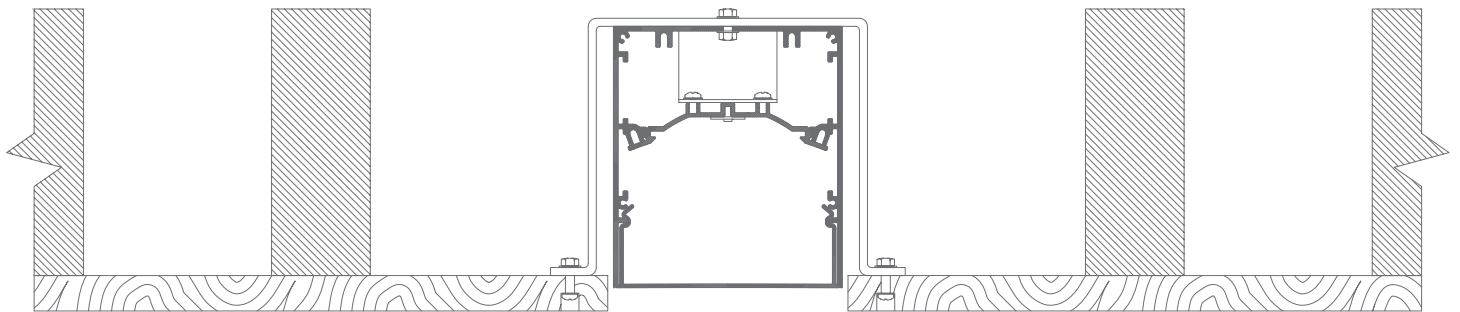



A photograph of a bicycle repair shop. In the foreground, a large, square, yellow-painted pillar stands prominently. Behind it, several bicycles are parked on black metal racks. The racks are arranged in rows, and the bicycles are of various colors, including red, blue, and white. The ceiling is white with recessed fluorescent lighting. The floor is a light gray. The overall scene is well-lit and organized.

## Product Specifications

# ProTools 60 Linear

- Recessed
- Suspended
- Surface
- Wall

Application guide  
Product details

28-43  
56-75





**ProTools 60 Linear** 2.4" aperture family offers straight runs or configurations for linear downlighting, wall washing, wall grazing and perimeter lighting with ultimate performance, superb glare control, lens / louver options and the Whitegoods attention to integration with surrounding materials.



# ProTools 60 Linear Family

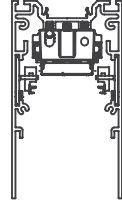

Surface/Recessed Housing

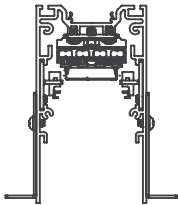

Recessed Plaster Trim

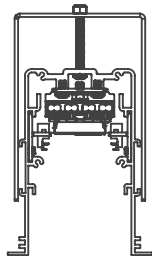

Recessed Bezel Trim

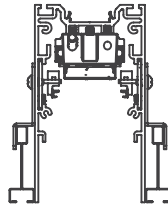

Recessed Grid

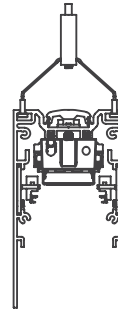

Suspended

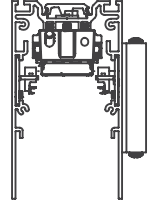

Wall/Mullion Mount

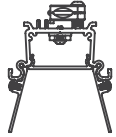

Recessed  
Micro-prismatic Lens

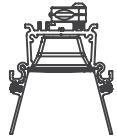

Recessed Louver

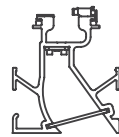

Wall Wash Lens

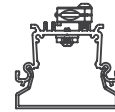

Regressed Opal Lens

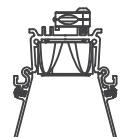

Recessed Narrow Optic

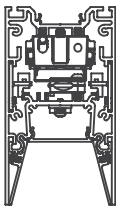

Recessed  
Micro-prismatic Lens

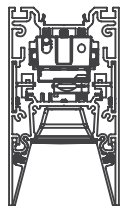

Recessed Louver

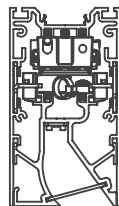

Recessed Lens + Wall Wash

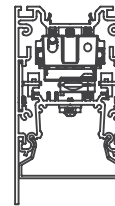

Regressed Opal Lens

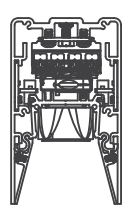

Recessed Narrow Optic

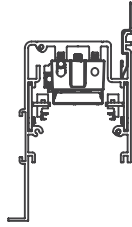

Recessed Perimeter Housing

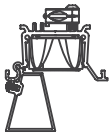

Recessed Elliptical Optic + Wall Graze



Louver + Wall Graze

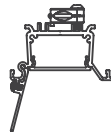

Perimeter Recessed Lens

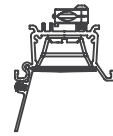

Perimeter with Recessed Louver

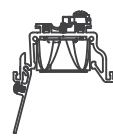

Perimeter with Recessed Elliptical Optic

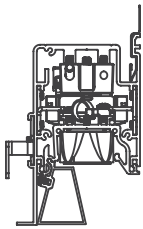

Recessed Elliptical Optic + Wall Graze

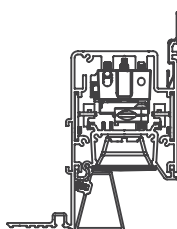

Recessed Louver + Wall Graze

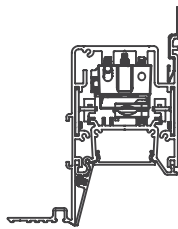

Recessed Micro-prismatic Lens

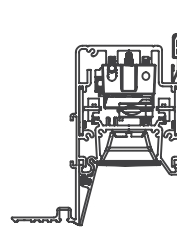

Recessed Louver

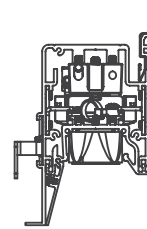

Recessed Elliptical Optic

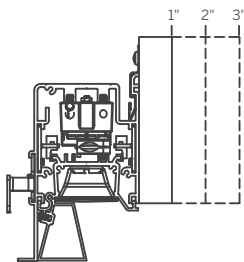

Soft Graze: 1" 2" 3"

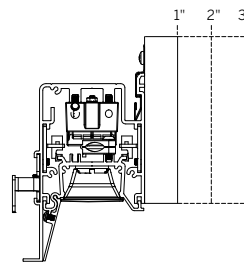

Soft Graze: 1" 2" 3"

# ProTools 60 Linear Features

## Quality of Light

Quality of light starts with the LED technology. Standard is 90+ CRI and 3-Step MacAdam Ellipse binning. These LED devices are used in all Whitegoods Linear products to ensure high quality and uniformity throughout any space designed using multiple Whitegoods products. Next, best of class drivers are used that precisely regulate the LED at full power as well as through a dimming range from 100% to 0.1% without flicker. Finally, precision optics are incorporated to place the light where it is intended, control brightness and not distort the color or the beam of light that is delivered to the space.

## Modularity

A key feature in all Whitegoods products is a modular approach to product and systems design. By developing interchangeable components within a product range, inventory, assembly, installation and specification are positively affected. A modular system reduces production time and speeds the install housing to the jobsite when it is needed.

ProTools 60 Linear is easy to specify; one linear form with many performance options. A common housing fitting all mounting requirements, and optical inserts with all the required lighting distributions allow even the most complex combinations to be easily configured.

Standards to fit most application requirements, and customization to fit every space

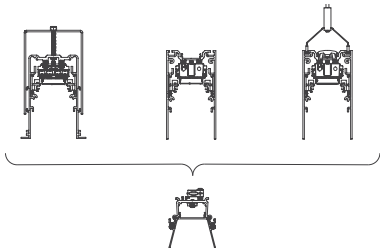

## Technology

Proprietary LED boards provide the most efficient and effective linear lighting solution that combines efficiency and brightness control in a small, integrate-able package. Whitegoods has specially designed a selection of constant current LED boards to be used consistently throughout its linear range.

Lumens Per Watt	Lumens Per Foot	CCT	CRI	L70	SDCM
170	350 - 2500	2700K - 4000K	92	72,000 HRS	3

\*nominal LED board lumens at 3000K

## Tuneable White Light

Tuneable White allows you to select any color temperature between 2200K and 4000K, while maintaining the same high quality color rendering as the standard LED. This feature is often used in health and wellness applications, as well as work spaces to increase productivity, architectural spaces to match natural light, and for design focus in retail and hospitality environments.

Color Temperature	Description	Typical Usage
4000K	Cool	Office, Exterior
3500K	Neutral Cool	Office
3000K	Neutral Warm	Office, Residential
2700K	Warm: Halogen Incandescent	Residential, Hotel
2200K	Very Warm Incandescent	Residential

## Control and Connectivity

ProTools 60 Linear is compatible with the major dimming technologies available on the market today: 0-10V, Lutron, DMX, DALI. In combination with our proprietary Constant Current LED boards, full-range, flicker-free dimming is available, even for high-definition video camera.

Wireless systems such as Casambi can be used for ease of localized control where flexibility and accessibility are considerations.

The use of POE (power over ethernet) technology allows ProTools 60 Linear products to be included into a local area network of electrical devices that can be easily configured for maximum control flexibility while minimizing wiring.

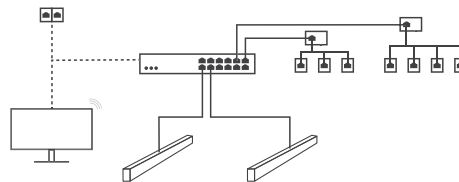

## Mechanical Integrity

Whitegoods has introduced the *Sure-lock* to ensure that the individual fixtures in a continuous run are not just aligned, but also drawn tightly together to create the most minimal seam. Passive means of holding fixtures together does not work. *Sure-lock* pulls the fixtures together and maintains a tight joint for the life of the installation.

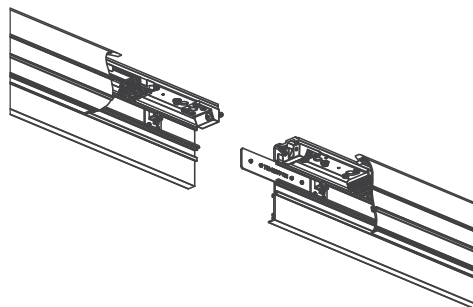

SH ■■  
MAN



# Delivering Illumination Without the Brightness



Typical Flush Lens



ProTools 60 Linear Recessed Lens

## Luminance

Luminance is the measure of how bright an object appears to the human eye and is a reading of the amount of light (candelas/m<sup>2</sup>) that reaches your eye. The luminance value, combined with the visual cut-off angle, is important in determining if a luminaire will be a glare nuisance in the space. The relationship between the luminance values of the luminaire and the ceiling will indicate the contrast between them. A contrast ratio  $> 5:1$  (luminaire to ceiling luminance) indicates that the luminaire will be a focal point in the space as it is significantly brighter than its surroundings. A ratio  $< 5:1$  (ex. 3:1) will indicate a very 'quiet' luminaire that will most likely not stand-out as the brightest object in the space.

All ProTools 60 Linear luminance values are indicated on their photometric reports. These photometric reports are also used to calculate the light levels in a space, and thus can be used to determine luminance of a surface such as walls and ceilings.

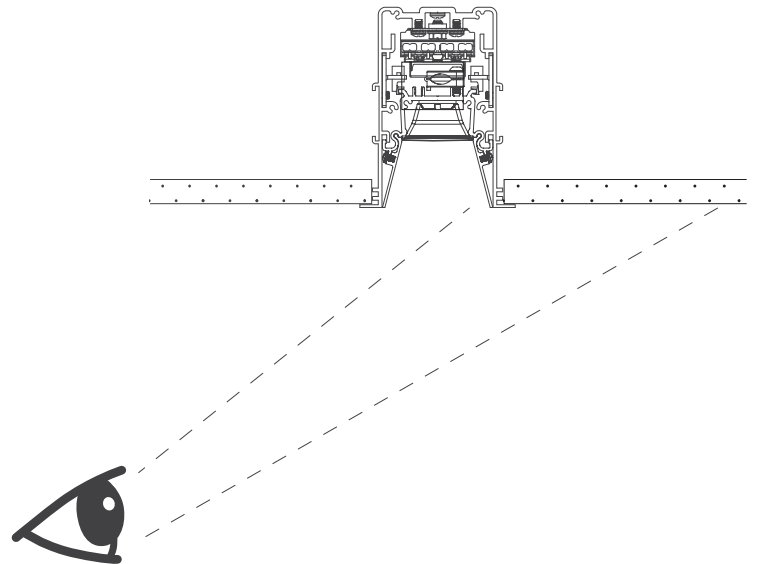

**Unified Glare Rating**

Unified Glare Rating is an indicative rating that designers can use to create a space that avoids the discomfort and distraction of glare. For luminaires, this rating is primarily based on a calculation that takes into account:

- Luminance value of the luminaire
- Background luminance
- Viewing angle to the light source as seen by people in the space

UGR is one way to compare the relative glare or brightness control of one luminaire versus another. A rating of <16 is acceptable for most spaces. The UGR rating for each ProTools 60 Linear luminaire is located on the photometric report and available at [inter-lux.com/whitegoods](http://inter-lux.com/whitegoods).

$$UGR = 16 \log \left[ \frac{0.25}{L_b} \sum \left( \frac{L^2 \omega}{p^2} \right) \right]$$

**Efficiency**

ProTools 60 Linear starts with the highest lumen per watt rating from the proprietary LED boards that are used throughout the Whitegoods brand. The design and technology that delivers light only where it is needed and simultaneously minimizes glare are sympathetic design features. High efficiency optics that include low brightness features are utilized to deliver light only where it is needed.

Luminaire efficiency is a measure of the light output of the luminaire in relation to the light output of the light source (LED). The higher the percentage of light that is emitted by the luminaire, the greater the efficiency. LED efficacy is represented by the amount of light emitted by the bare LED in ratio to the power expended to produce that light expressed in lumens per watt.

The system efficacy would be the ratio of light emitted from the luminaire in relation to the power expended, expressed in delivered lumens/watt. Thus the more light that is allowed to exit the luminaire, the more efficient the design is and the fewer watts per square foot could be your design – if all the light goes where you need it!

We feel that beam control is also a factor in luminaire efficiency. That is why ProTools 60 Linear is offered with various optics and reflectors to accommodate any application in the most efficient manner.

**LED Efficiency (180 lumens per watt)**

Lens	Luminaire	System Efficacy
Recessed Micro-prismatic Lens	59%	78 lumens per watt
Recessed Black Louver	87%	101 lumens per watt
Regressed Opal Lens	54%	72 lumens per watt

\*Based on 3000K LED

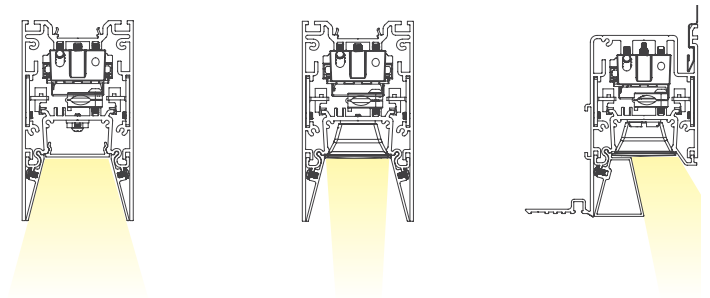

# Protools 60 Linear Wall Graze / Soft Graze

Wall Graze



Soft Graze 1"

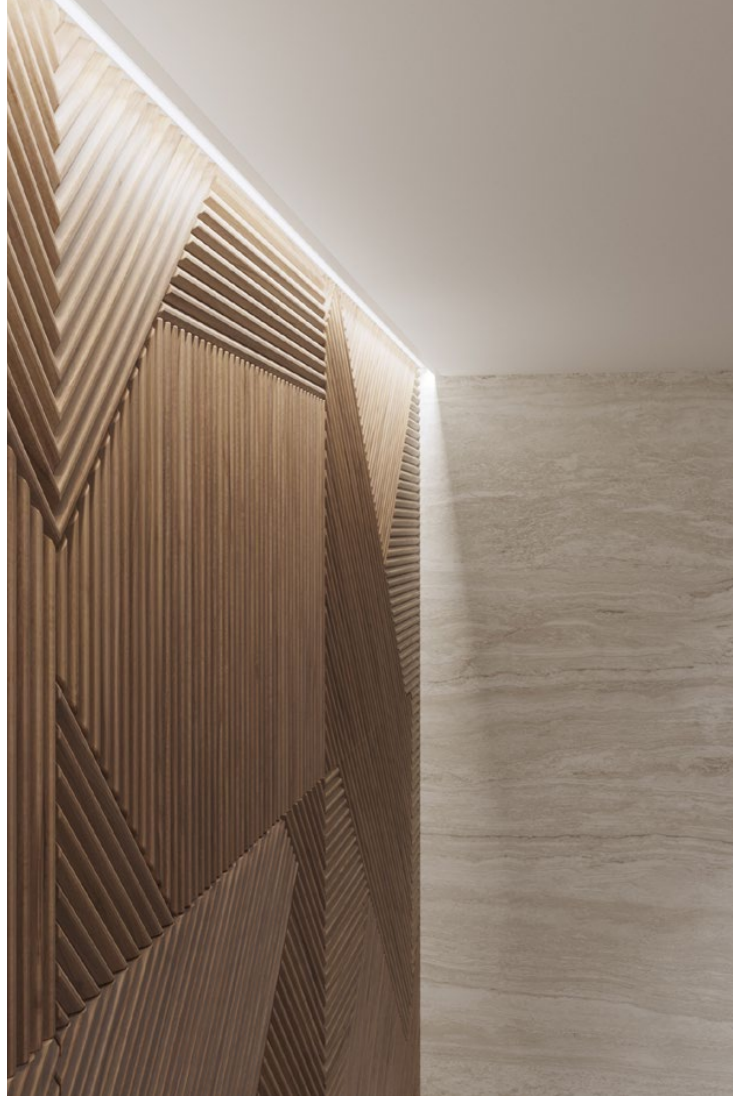



All feature walls are not created equal -so why graze them in the same way?

ProTools 60 Linear Wall Graze and Soft Graze allow you to illuminate a wall surface with the appropriate set-back so you can control the amount of contrast that is visible on a textured or patterned surface.

Absolute brightness control eliminates glare and ensures that the wall is the brightest feature.

The luminaire housing allows the wall to be illuminated full height and from above the ceiling plane.

The Soft Graze bracket integrates seamlessly between the wall and the luminaire to offer fine-tuning of the wall contrast for just the right effect.

Of course further fine tuning is possible by specifying any of the standard color temperatures available from 2700-4000K. Or specify Tuneable White that allows you to change the color temperature from 2200K to 4000K at any time.

Additionally, flicker-free, full-range dimming is standard and an absolute requirement in video spaces.

A range of lumen output options and optics are suited to graze walls from 8' to above 30' in height.

### **Soft Graze 2"**

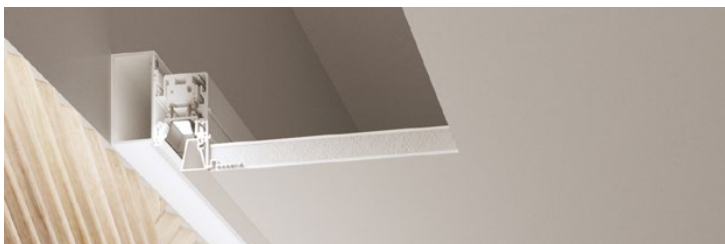

### **Soft Graze 3"**

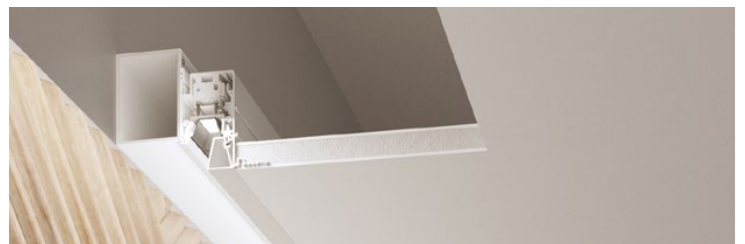
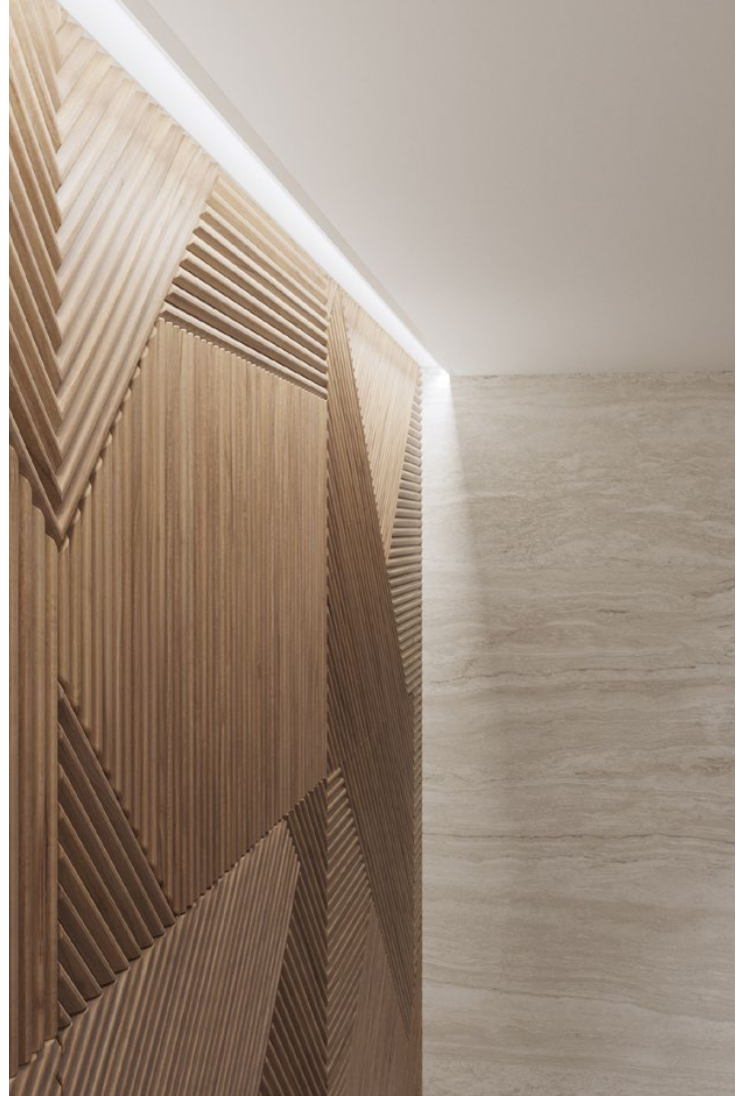

# ProTools 60 Linear Downlight

## Recessed

- 2.4" aperture, integrated solution that is compatible with all ceiling types
- Standard and tailored run lengths, including corners
- Downlight inserts for spaces up to 30' high
- Control and connectivity options
- Choice of beam spreads to accommodate all applications
- Extreme brightness control and the elimination of disturbing glare
- Modularity of insert modules for ultimate design flexibility
- Consistent LED technology throughout the Whitegoods product range
- Flexible design allows exact wall-to-wall dimensions
- Flicker-free full range dimming with standard driver (Eldoled)
- Manufactured in the USA

<b>Housing</b>	Precision extruded aluminum for true dimensions and tolerances Toolless component assembly from below Perfect fit with inserts, louvers and lenses Standard and tailored lengths including corner configurations Recessed snap-in cover for non-illuminated section Finishes: white, black, silver and custom
<b>Integration</b>	Fixation into gypsum, hard ceilings and all grid ceiling types
<b>Distribution</b>	30, 35, 50, 80, 105 degree symmetrical downlight
<b>LED</b>	>90 CRI, 3-Step MacAdam, 2700-4000K static white 3W - 15W per foot, 180 nominal lumens per watt average RA 91-94 (2700-4000K) L70 (TM21 Projected 85C) Static White / Tunable White = 72,000 hours Tunable white 2200-4000K, 80 nominal lumens per watt average
<b>Optic</b>	RML - recessed micro-prismatic lens   diffusion with maximum efficiency ROL - regressed opal acrylic lens   evenly illuminated line of light RLW/RLB - recessed louver white (W) or black (B)   extreme cutoff RNO - recessed narrow optic   narrow beam with maximum punch
<b>Reflector</b>	White: high efficiency (standard with RLW) Black: no brightness (standard with RLB) Silver: low brightness All 15% gloss Custom finish available
<b>Driver</b>	Compatible with quality constant current drivers
<b>Connectivity</b>	POE Wireless
<b>Weight</b>	4lbs per foot
<b>Operating Temp</b>	Suitable for operation in maximum ambient temperature of 35C (95F)
<b>Warranty</b>	5-year Limited (see complete company warranty information)
<b>Certifications</b>	ETL and ETL-C for dry and damp location, CE, Chicago plenum
<b>Voltages</b>	120-277VAC

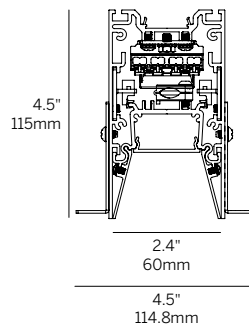
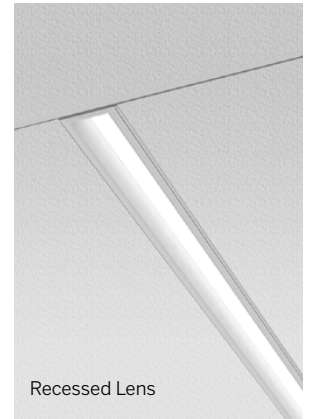
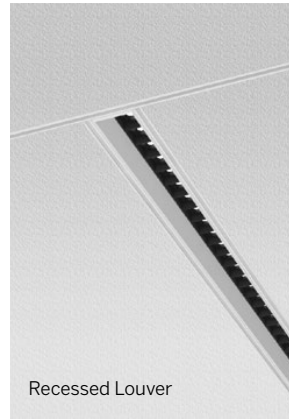
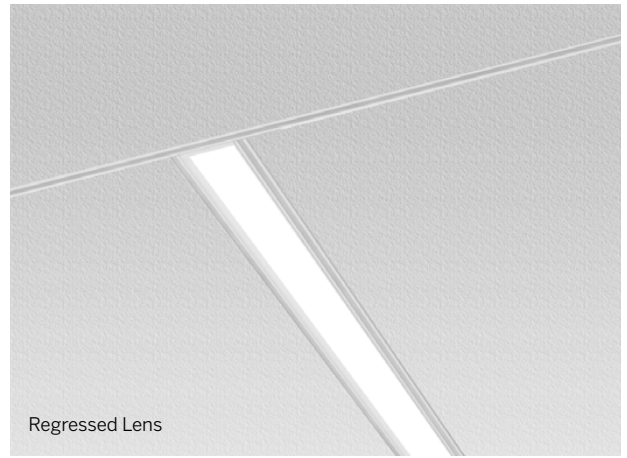

Recessed Micro-prismatic Lens (RML)

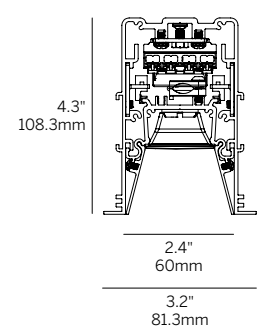

Recessed Louver (RLW, RLB)

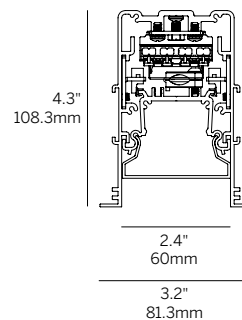

Regressed Opal Lens (ROL)

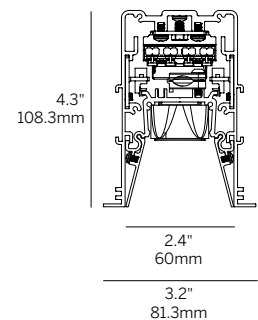

Recessed Narrow Optic (RNO)

# ProTools 60 Linear Downlight

## Recessed

Model	Fixation	Pattern	Length <sup>2</sup>	CRI/CCT	Optic <sup>3</sup>	Beam	Power <sup>5</sup>	Driver <sup>6</sup>	Housing Finish <sup>7</sup>	Reflector Finish <sup>7</sup>	Options
WG-60PTL	RPT	S	24	927	RML	80	P1	E1	W (std)	W	CP
	RBT	P <sup>1</sup>	48	930	ROL	105	P2	L1	B	B	EM
	RGT9	PPI <sup>1</sup>	96	935	ROL	105	P3	POE	S	S	NYC
	RGT15	PPO <sup>1</sup>	XX <sup>3</sup>	940	RLW	35	P4	BT	F	F	TF
	RGTS	PZ <sup>1</sup>		TW <sup>4</sup>	RLB	50		DALI			WC
					RNO	30		TQ			

### Model

- WG-60PTL = ProTools 60 Linear Downlight

### Fixation

- RPT = Recessed plaster trim
- RBT = Recessed trim for hard ceiling
- RGT9 = Recessed trim for 9/16" grid
- RGT15 = Recessed trim for 15/16" grid
- RGTS = Recessed trim for slot grid

### Pattern

- S = Straight run
- P = Standard patterns 2, 3 or 4 sided with 90° corners on the same plane<sup>1</sup>
- PPI = Pattern, Plane to Plane, Inside. 2-3-4 sided pattern with inside corners<sup>1</sup>
- PPO = Pattern, Plane to Plane, Outside. 2-3-4 sided pattern with outside corners<sup>1</sup>
- PZ = Non-standard patterns and/or corners other than 90° on multiple planes, consult factory<sup>1</sup>

### Length<sup>2</sup>

- 24 = 24"
- 48 = 48"
- 96 = 96"
- XX = Specify inches to the nearest 0.25"<sup>3</sup>

### CRI/CCT (90+ CRI)

- 927 = 2700K
- 930 = 3000K
- 935 = 3500K
- 940 = 4000K
- TW = Tuneable white 2200-4000K<sup>4</sup>

### Optic<sup>3</sup>

- RML = Recessed micro-prismatic lens
- ROL = Regressed opal lens
- RLW = Recessed louver white (supplied with white reflectors standard)
- RLB = Recessed louver black (supplied with black reflectors only)
- RNO = Recessed narrow optic

### Beam

- 80 = 80° (RML)
- 105 = 105° (ROL)
- 35 = 35° (RLW, RLB)
- 50 = 50° (RLW, RLB)
- 30 = 30° (RNO)

### Power<sup>5</sup>

- P1 = 3W/ft
- P2 = 6W/ft
- P3 = 10W/ft
- P4 = 15W/ft

### Driver<sup>6</sup>

- E1 = EidoLED 0.1% dimming, 0-10V (120-277V)
- L1 = Lutron 1% dimming, Ecosystem (120-277V)
- PoE = Power over Ethernet
- BT = Wireless CAS – Casambi (Must specify BT with E1 or DALI)
- DALI = EidoLED Dali DT8 0.1% (120-277V)
- TQ = T-Series for Lutron Quantum 0.1% (120-277V) (Tunable white ONLY)

### Housing / Trim Finish<sup>7</sup>

- W = White, 15% gloss, RAL 9003 / Tiger Drylac 049/11350 (standard)
- B = Black, 15% gloss, RAL 9005 / Tiger Drylac 044/90053
- S = Silver, 15% gloss, RAL 9006 / Tiger Drylac 049/90500
- F = Custom finished trim, specify RAL

### Reflector Finish<sup>7</sup>

- W = White, 15% gloss, RAL 9003 / Tiger Drylac 049/11350 (standard with RLW)
- B = Black, 15% gloss, RAL 9005 / Tiger Drylac 044/90053 (standard with RLB)
- S = Silver, 15% gloss, RAL 9006 / Tiger Drylac 049/90500
- F = Custom finished trim, specify RAL

### Options

- CP = Chicago Plenum Rated
- EM = Emergency (remote)
- NYC = 6' whip per run
- TF = Top feed
- WC = Wood Ceiling (trimless - accessible ceilings only)

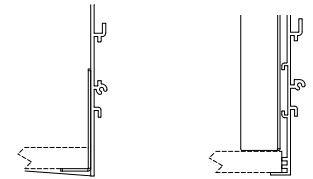

Plaster trim (RPT)

Recessed trim (RBT)

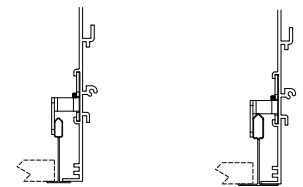

9/16" grid (RGT9)

15/16" grid (RGT15)

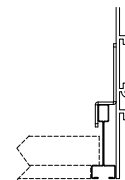

Slot (RGTS)

Whitegoods reserves the right to change any information without prior notice.

### Notes

- See pattern spec sheet.
- Individual fixture lengths less than 2' may require remote driver.
- Specify Lensed products to nearest 0.25". Specify Louvered and Tuneable White products in 6" increments for continuous light. Louver supplied in 6" increments, balance of the run will have recessed blank covers on ends.
- TW only available with RML/ROL for P2 and P3.
- Refer to specsheet for delivered lumen data for all product configurations.
- See power supply page for details.
- See Tiger Drylac color chart: [inter-lux.com/tiger](http://inter-lux.com/tiger)

index

technical  
information



# ProTools 60 Linear Downlight

## 6" / 12" Recessed

- 2.4" aperture, integrated solution that is compatible with all ceiling types
- Standard 6" and 12" lengths
- Control and connectivity options
- Choice of beam spreads to accommodate all applications
- Extreme brightness control and the elimination of disturbing glare
- Modularity of insert modules for ultimate design flexibility
- Consistent LED technology throughout the Whitegoods product range
- Flicker-free full range dimming with standard driver (Eldoled)
- Manufactured in the USA

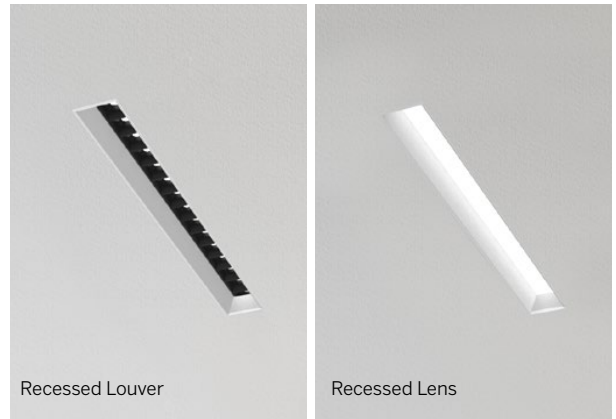

**Housing** Precision extruded aluminum for true dimensions and tolerances  
 Toolless component assembly from below  
 Perfect fit with inserts, louvers and lenses  
 Standard 6" and 12" lengths  
 Recessed snap-in cover for non-illuminated section  
 Finishes: white, black, silver and custom

**Integration** Fixation into gypsum, hard ceilings and all grid ceiling types

**Distribution** 35, 50, 80, 105 degree symmetrical downlight and wall wash

**LED** >90 CRI, 3-Step MacAdam, 2700-4000K static white  
 3W - 15W per foot, 180 nominal lumens per watt average  
 RA 91-94 (2700-4000K)  
 L70 (TM21 Projected 85C) Static White / Tunable White = 72,000 hours  
 Tuneable white 2200-4000K, 80 lumens per watt average

**Optic** RML - recessed micro-prismatic lens | diffusion with maximum efficiency  
 ROL - regressed opal acrylic lens | evenly illuminated line of light  
 RLW/RLB - recessed louver white (W) or black (B) | extreme cutoff  
 LML - Linear micro-prismatic lens - diffusion and efficiency for wall wash

**Reflector** White: high efficiency (standard with RLW)  
 Black: no brightness (standard with RLB, not offered with LML)  
 Silver: low brightness  
 All 15% gloss  
 Custom finish available

**Driver** Compatible with quality constant current drivers

**Connectivity** POE  
 Wireless

**Weight** 4lbs per foot

**Operating Temp** Suitable for operation in maximum ambient temperature of 35C (95F)

**Warranty** 5-year Limited (see complete company warranty information)

**Certifications** ETL and ETL-C for dry and damp location, CE, Chicago plenum

**Voltages** 120-277VAC

Recessed Micro-prismatic Lens (RML)

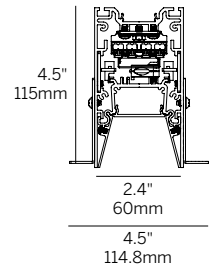
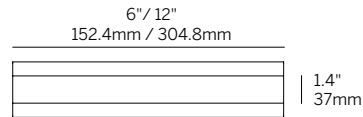

Regressed Opal Lens (ROL)

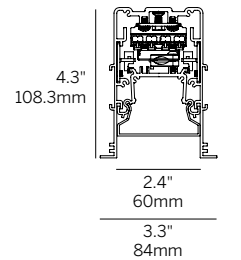
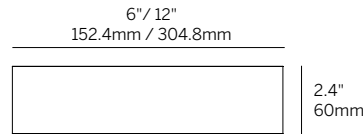

Recessed Louver (RLW, RLB)

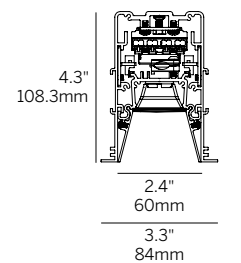
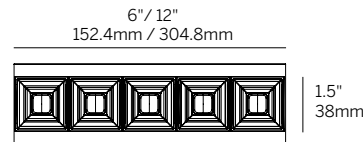

Recessed Lens + Wall Wash (LML + WW)

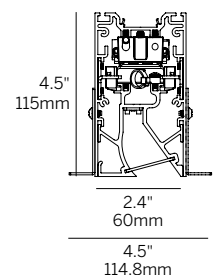
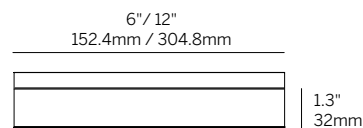

# ProTools 60 Linear Downlight

## 6" / 12" Recessed

Model	Fixation	Pattern	Length	CRI/CCT	Optic	Beam	Power <sup>2</sup>	Driver <sup>3</sup>	Housing Finish <sup>4</sup>	Reflector Finish <sup>4</sup>	Options
WG-60PTL	RPT RBT	S	6 12	927	RML	80	P1	E1	W (std)	W	CP
				930	ROL	105	P2	L1	B	B	EM
				935	RLW	35	P3	POE	S	S	NYC
				940	RLB	50	P4	BT	F	F	TF
				TW <sup>1</sup>	LML	WW					WC

### Model

- WG-60PTL = ProTools 60 Linear Downlight 6" / 12" Recessed

### Fixation

- RPT = Recessed plaster trim
- RBT = Recessed trim for hard ceiling

### Pattern

- S = Straight run

### Length

- 6 = 6"
- 12 = 12"

### CRI/CCT (90+ CRI)

- 927 = 2700K
- 930 = 3000K
- 935 = 3500K
- 940 = 4000K
- TW = Tuneable white 2200-4000K<sup>1</sup>

### Optic

- RML = Recessed micro-prismatic lens
- ROL = Regressed opal lens
- RLW = Recessed louver white (supplied with white reflectors standard)
- RLB = Recessed louver black (supplied with black reflectors only)
- LML = Linear micro-prismatic lens

### Beam

- 80 = 80° (RML)
- 105 = 105° (ROL)
- 35 = 35° (RLW, RLB)
- 50 = 50° (RLW, RLB)
- WW = Wall Wash (LML)

### Power<sup>2</sup>

- P1 = 3W/ft
- P2 = 6W/ft
- P3 = 10W/ft
- P4 = 15W/ft

### Driver (Remote)<sup>3</sup>

- E1 = EldoLED 0.1% dimming, 0-10V (120-277V)
- L1 = Lutron 1% dimming, Ecosystem (120-277V)
- PoE = Power over Ethernet
- BT = Wireless CAS – Casambi (Must specify BT with E1 or DALI)
- DALI = EldoLED Dali DT8 0.1% (120-277V)
- TQ = T-Series for Lutron Quantum 0.1% (120-277V) (Tunable white ONLY)

### Housing / Trim Finish<sup>7</sup>

- W = White, 15% gloss, RAL 9003 / Tiger Drylac 049/11350 (standard)
- B = Black, 15% gloss, RAL 9005 / Tiger Drylac 044/90053
- S = Silver, 15% gloss, RAL 9006 / Tiger Drylac 049/90500
- F = Custom finished trim, specify RAL

### Reflector Finish<sup>7</sup>

- W = White, 15% gloss, RAL 9003 / Tiger Drylac 049/11350 (standard with RLW)
- B = Black, 15% gloss, RAL 9005 / Tiger Drylac 044/90053 (standard with RLB, not offered with LML)
- S = Silver, 15% gloss, RAL 9006 / Tiger Drylac 049/90500
- F = Custom finished trim, specify RAL

### Options

- CP = Chicago Plenum Rated
- EM = Emergency (remote)
- NYC = 6' whip per run
- TF = Top feed
- WC = Wood Ceiling (trimless - accessible ceilings only)



Plaster trim (RPT)

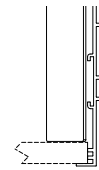

Recessed trim (RBT)

Whitegoods reserves the right to change any information without prior notice.

### Notes

- TW only available with RML/ROL/LML for P2 and P3.
- Refer to specsheet for delivered lumen data for all product configurations.
- See power supply page for details.
- See Tiger Drylac color chart: [inter-lux.com/tiger](http://inter-lux.com/tiger)

index

technical  
information



# ProTools 60 Linear Wall Wash Recessed

- 2.4" aperture, integrated solution that is compatible with all ceiling types
- Standard and tailored run lengths, including corners
- Wash to 30' wall height
- Extreme brightness control and the elimination of disturbing glare
- Modularity of insert modules for ultimate design flexibility
- Consistent LED technology throughout the Whitegoods product range
- Evenly illuminate the wall from top to the bottom with smooth gradation
- Flexible design allows exact wall-to-wall dimensions
- Flicker-free full range dimming with standard driver (Eldoled)
- Manufactured in the USA

<b>Housing</b>	Precision extruded aluminum for true dimensions and tolerances Toolless component assembly from below Perfect fit with inserts, louvers and lenses Standard and tailored lengths including corner configurations Recessed snap-in cover for non-illuminated section Finishes: white, silver and custom
<b>Integration</b>	Fixation into gypsum, hard ceilings and all grid ceiling types
<b>Distribution</b>	Wall Wash
<b>LED</b>	>90 CRI, 3-Step MacAdam, 2700-4000K static white, constant current 3W - 15W per foot, 180 nominal lumens per watt average RA 91-94 (2700-4000K) L70 (TM21 Projected 85C) Static White / Tunable White = 72,000 hours Tunable white 2200-4000K, 80 nominal lumens per watt average
<b>Optic</b>	LML - Linear micro-prismatic lens - diffusion and efficiency for wall wash
<b>Reflector</b>	White: high efficiency Silver: low brightness All 15% gloss Custom finish available
<b>Driver</b>	Compatible with quality constant current drivers
<b>Connectivity</b>	POE Wireless
<b>Weight</b>	4lbs per foot
<b>Operating Temp</b>	Suitable for operation in maximum ambient temperature of 35C (95F)
<b>Warranty</b>	5-year Limited (see complete company warranty information)
<b>Certifications</b>	ETL and ETL-C for dry and damp location, CE, Chicago plenum
<b>Voltages</b>	120-277VAC

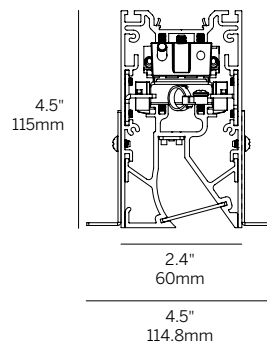
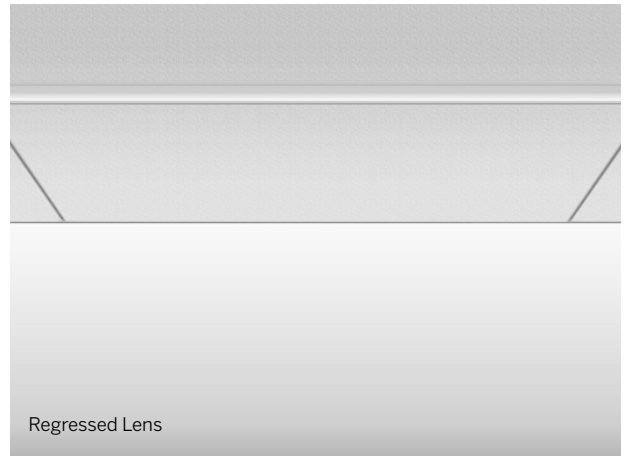

Recessed Lens + Wall Wash  
(LML + WW)

# ProTools 60 Linear Wall Wash

## Recessed

Model	Fixation	Pattern	Length <sup>2</sup>	CRI/CCT	Optic	Beam	Power <sup>5</sup>	Driver <sup>6</sup>	Housing Finish <sup>7</sup>	Reflector Finish <sup>7</sup>	Options
WG-60PTLWW	RPT RBT RGT9 RGT15 RGTS	S PI <sup>1</sup> PO <sup>1</sup> PZ <sup>1</sup>	24 48 96 XX <sup>3</sup>	927 930 935 940 TW <sup>4</sup>	LML	WW	P1 P2 P3 P4	E1 L1 POE BT DALI TQ	W (std) S F	W S F	CP EM NYC TF WC

### Model

- WG-60PTLWW = ProTools 60 Linear Wall Wash

### Fixation

- RPT = Recessed plaster trim
- RBT = Recessed trim for hard ceiling
- RGT9 = Recessed trim for 9/16" grid
- RGT15 = Recessed trim for 15/16" grid
- RGTS = Recessed trim for slot grid

### Pattern

- S = Straight run
- PI = Standard patterns 2, 3 or 4 sided with 90° inside corners on the same plane<sup>1</sup>
- PO = Standard patterns 2, 3 or 4 sided with 90° outside corners on the same plane<sup>1</sup>
- PZ = Non-standard patterns and/or corners other than 90° on multiple planes, consult factory<sup>1</sup>

### Length<sup>2</sup>

- 24 = 24"
- 48 = 48"
- 96 = 96"
- XX = Specify inches to the nearest 0.25"<sup>3</sup>

### CRI/CCT (90+ CRI)

- 927 = 2700K
- 930 = 3000K
- 935 = 3500K
- 940 = 4000K
- TW = Tuneable white 2200-4000K<sup>4</sup>

### Optic

- LML = Linear micro-prismatic lens

### Beam

- WW = Wall Wash

### Power<sup>5</sup>

- P1 = 3W/ft
- P2 = 6W/ft
- P3 = 10W/ft
- P4 = 15W/ft

### Driver<sup>6</sup>

- E1 = EldoLED 0.1% dimming, 0-10V (120-277V)
- L1 = Lutron 1% dimming, Ecosystem (120-277V)
- PoE = Power over Ethernet
- BT = Wireless CAS – Casambi (Must specify BT with E1 or DALI)
- DALI = EldoLED Dali DT8 0.1% (120-277V)
- TQ = T-Series for Lutron Quantum 0.1% (120-277V) (Tunable white ONLY)

### Housing / Trim Finish<sup>7</sup>

- W = White, 15% gloss, RAL 9003 / Tiger Drylac 49/11350 (standard)
- S = Silver, 15% gloss, RAL 9006 / Tiger Drylac 49/90500
- F = Custom finished trim, specify RAL

### Reflector Finish<sup>7</sup>

- W = White, 15% gloss, RAL 9003 / Tiger Drylac 049/11350
- S = Silver, 15% gloss, RAL 9006 / Tiger Drylac 049/90500
- F = Custom finished trim, specify RAL

### Options

- CP = Chicago Plenum Rated
- EM = Emergency (remote)
- NYC = 6' whip per run
- TF = Top feed
- WC = Wood Ceiling (trimless - accessible ceilings only)



Plaster trim (RPT)

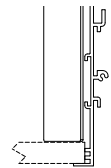

Recessed trim (RBT)

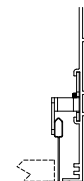

9/16" grid (RGT9)

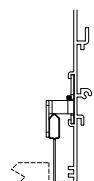

15/16" grid (RGT15)

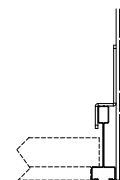

Slot (RGTS)

Whitegoods reserves the right to change any information without prior notice.

### Notes

- See pattern spec sheet.
- Individual fixture lengths less than 2' may require remote driver.
- For Lensed products, specify to nearest 0.25".
- TW only available for P2 and P3.
- Refer to specsheet for delivered lumen data for all product configurations.
- See power supply page for details.
- See Tiger Drylac color chart: [inter-lux.com/tiger](http://inter-lux.com/tiger)

index

technical  
information



# ProTools 60 Linear Wall Graze Recessed

- 2.4" aperture, integrated solution that is compatible with all ceiling types
- Standard and tailored run lengths, including corners
- Graze to 30' wall height
- *Soft Graze* to vary light center from the wall
- Extreme brightness control and the elimination of disturbing glare
- Consistent LED technology throughout the Whitegoods product range
- Easy to install housing allows the wall to continue above the finished ceiling
- Flexible design allows exact wall-to-wall dimensions
- Flicker-free full range dimming with standard driver (Eldoled)
- Manufactured in the USA

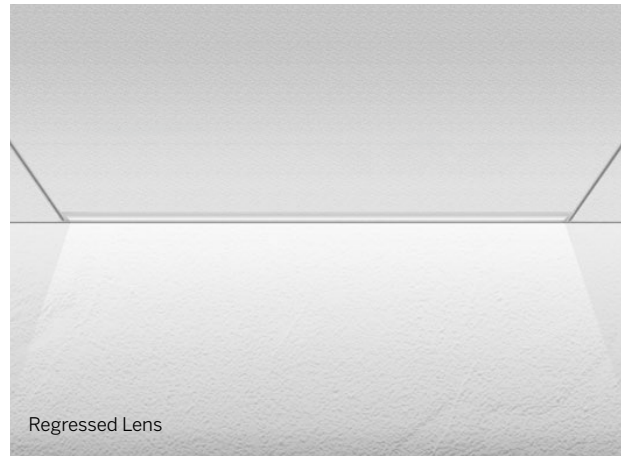

**Housing** Precision extruded aluminum for true dimensions and tolerances  
 Toolless component assembly from below  
 Perfect fit with inserts, louvers and lenses  
 Standard and tailored lengths including corner configurations  
*Soft Graze* adds 1" - 3" additional set-off for less dramatic graze  
 Recessed snap-in cover for non-illuminated section  
 Finishes: white, black, silver and custom

**Integration** Fixation into gypsum, hard ceilings and all grid ceiling types  
 Finished wall continues past the ceiling line

**Distribution** Wall Graze and *Soft Graze*

**LED** >90 CRI, 3-Step MacAdam; 2700K-4000K static white, constant current  
 3W - 15W per foot, 180 nominal lumens per watt average  
 RA 91-94 (2700-4000K)  
 L70 (TM21 Projected 85C) Static White = 72,000 hours

**Optic** RLW/RLB - recessed louver white (W) or black (B) | extreme cutoff  
 REO - Recessed elliptical optic - high efficiency graze

**Reflector** White: high efficiency (standard with RLW)  
 Black: no brightness (standard with RLB)  
 Silver: low brightness  
 All 15% gloss  
 Custom finish available

**Driver** Compatible with quality constant current drivers

**Connectivity** POE  
 Wireless

**Weight** 4lbs per foot

**Operating Temp** Suitable for operation in maximum ambient temperature of 35C (95F)

**Warranty** 5-year Limited (see complete company warranty information)

**Certifications** ETL and ETL-C for dry and damp location

**Voltages** 120-277VAC

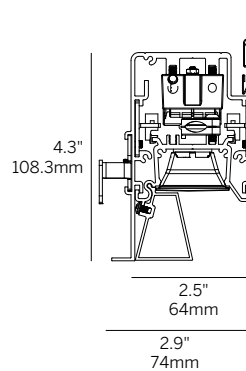

Recessed Louver  
(LW, RLB + WG)

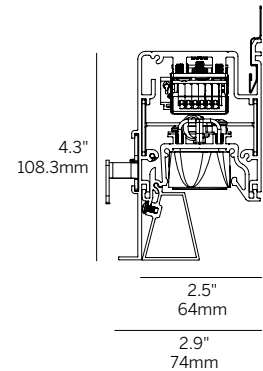

Recessed Elliptical Optic  
(REO + WG)

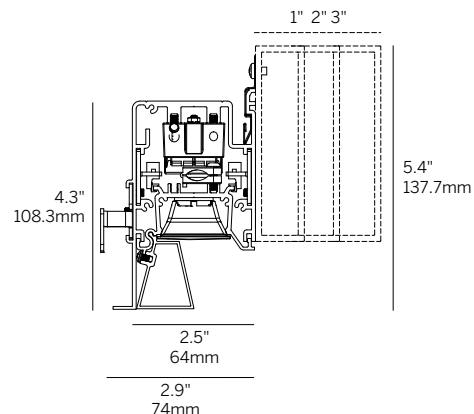

Recessed Louver  
(SG1 + RLW, RLB)



# ProTools 60 Linear Wall Graze

## Recessed

Model	Fixation	Pattern	Length <sup>2</sup>	CRI/CCT	Optic <sup>3</sup>	Beam	Power <sup>4</sup>	Driver <sup>5</sup>	Housing Finish <sup>6</sup>	Options
WG-60PTLWG	RPT	S	24	927	RLW	WG	P1	E1	W	CP
WG-60PTLSG1	RBT	PI <sup>1</sup>	48	930	RLB		P2	L1	B	EM
WG-60PTLSG2	RGT9	PO <sup>1</sup>	96	935	REO		P3	POE	S	NYC
WG-60PTLSG3	RGT15		XX <sup>3</sup>	940			P4	BT DALI	F	TF

### Model

- WG-60PTLWG = ProTools 60 Linear Wall Graze
- WG-60PTLSG1 = ProTools 60 Linear *Soft Graze* 1" extension
- WG-60PTLSG2 = ProTools 60 Linear *Soft Graze* 2" extension
- WG-60PTLSG3 = ProTools 60 Linear *Soft Graze* 3" extension

### Fixation

- RPT = Recessed plaster trim
- RBT = Recessed trim for hard ceiling
- RGT9 = Recessed trim for 9/16" grid
- RGT15 = Recessed trim for 15/16" grid
- RGTS = Recessed trim for slot grid

### Pattern

- S = Straight run
- PI = Standard patterns 2, 3 or 4 sided with 90° inside corners on the same plane<sup>1</sup>
- PO = Standard patterns 2, 3 or 4 sided with 90° outside corners on the same plane<sup>1</sup>

### Length<sup>2</sup>

- 24 = 24"
- 48 = 48"
- 96 = 96"
- XX = Specify inches to the nearest 0.25"<sup>3</sup>

### CRI/CCT (90+ CRI)

- 927 = 2700K
- 930 = 3000K
- 935 = 3500K
- 940 = 4000K

### Optic<sup>3</sup>

- RLW = Recessed louver white (supplied with white reflectors standard)
- RLB = Recessed louver black (supplied with black reflectors only)
- REO = Recessed elliptical optic

### Beam

- WG = Wall Graze

### Power<sup>4</sup>

- P1 = 3W/ft
- P2 = 6W/ft
- P3 = 10W/ft
- P4 = 15W/ft

### Driver<sup>5</sup>

- E1 = EidoLED 0.1% dimming, 0-10V (120-277V)
- L1 = Lutron 1% dimming, Ecosystem (120-277V)
- PoE = Power over Ethernet
- BT = Wireless CAS – Casambi (Must specify BT with E1 or DALI)
- DALI = EidoLED Dali DT8 0.1% (120-277V)

### Housing / Trim Finish (Includes kick reflector)<sup>6</sup>

- W = White, 15% gloss, RAL 9003 / Tiger Drylac 049/11350 (standard with RLW)
- B = Black, 15% gloss, RAL 9005 / Tiger Drylac 044/90053 (standard with RLB)
- S = Silver, 15% gloss, RAL 9006 / Tiger Drylac 049/90500
- F = Custom finished trim, specify RAL

### Options

- CP = Chicago Plenum Rated
- EM = Emergency (remote)
- NYC = 6' whip per run
- TF = Top feed

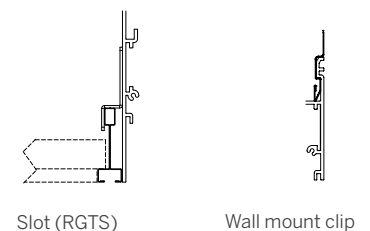
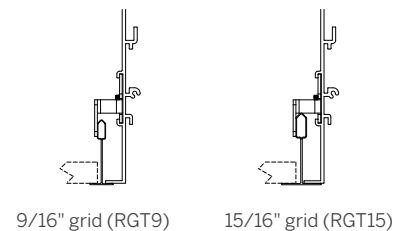
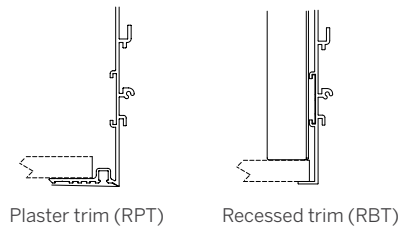

Whitegoods reserves the right to change any information without prior notice.

### Notes

- 1 See pattern spec sheet.
- 2 Individual fixture lengths less than 2' may require remote driver.
- 3 Specify Lensed products to nearest 0.25". Specify Louvered and Tuneable White products in 6" increments for continuous light. Louver supplied in 6" increments, balance of the run will have recessed blank covers on ends.
- 4 Refer to specsheet for delivered lumen data for all product configurations.
- 5 See power supply page for details.
- 6 See Tiger Drylac color chart: [inter-lux.com/tiger](http://inter-lux.com/tiger)

index

technical  
information



# ProTools 60 Linear Perimeter Recessed

- 2.4" aperture, integrated solution that is compatible with all ceiling types
- Standard and tailored run lengths, including corners
- Evenly illuminated perimeter lighting system
- *Soft Graze* option to vary light center from the wall
- Recessed optics minimizes brightness
- Consistent LED technology throughout the Whitegoods product range
- Easy to install housing allows the wall to continue above the finished ceiling
- Flexible design allows exact wall-to-wall dimensions
- Flicker-free full range dimming with standard driver (Eldoled)
- Manufactured in the USA

<b>Housing</b>	Precision extruded aluminum for true dimensions and tolerances Toolless component assembly from below Perfect fit with inserts, louvers and lenses Standard and tailored lengths including corner configurations <i>Soft Graze</i> adds 1" - 3" additional set-off for less dramatic graze Recessed snap-in cover for non-illuminated section Finishes: white, black, silver and custom
<b>Integration</b>	Fixation into gypsum, hard ceilings and all grid ceiling types Finished wall continues past the ceiling line
<b>Distribution</b>	Evenly illuminated regressed, recessed lens or <i>Soft Graze</i>
<b>LED</b>	>90 CRI, 3-Step MacAdam, 2700-4000K static white 3W - 15W per foot, 180 nominal lumens per watt average RA 91-94 (2700-4000K) L70 (TM21 Projected 85C) Static White / Tunable White = 72,000 hours Tunable white 2200-4000K, 80 nominal lumens per watt average
<b>Optic</b>	RML - recessed micro-prismatic lens   diffusion with maximum efficiency RLW/RLB - recessed louver white (W) or black (B)   extreme cutoff REO - Recessed elliptical optic - high efficiency graze
<b>Reflector</b>	White: high efficiency (standard with RLW) Black: no brightness (standard with RLB) Silver: low brightness All 15% gloss Custom finish available
<b>Driver</b>	Compatible with quality constant current drivers
<b>Connectivity</b>	POE Wireless
<b>Weight</b>	4lbs per foot
<b>Operating Temp</b>	Suitable for operation in maximum ambient temperature of 35C (95F)
<b>Warranty</b>	5-year Limited (see complete company warranty information)
<b>Certifications</b>	ETL and ETL-C for dry and damp location, CE, Chicago plenum
<b>Voltages</b>	120-277VAC

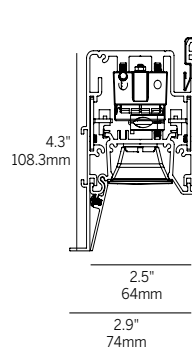
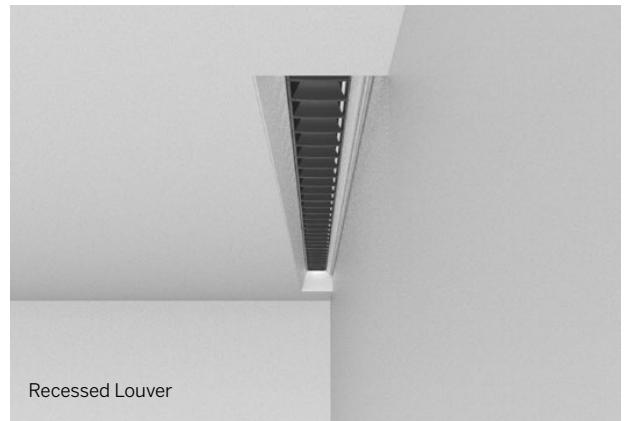
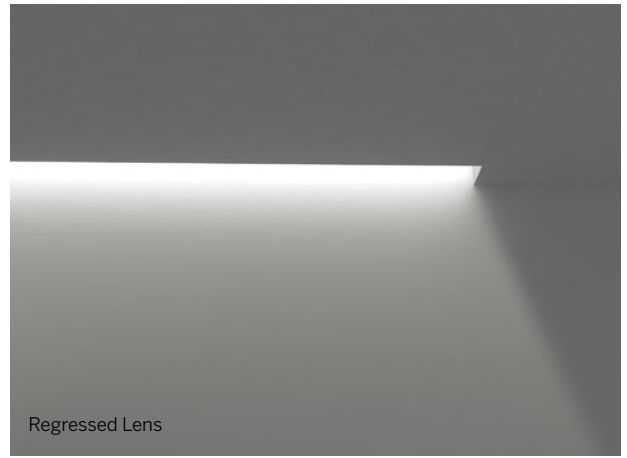

Recessed Louver (RLW, RLB)

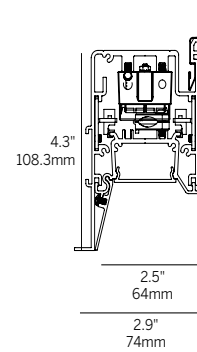

Recessed Micro-prismatic Lens (RML)

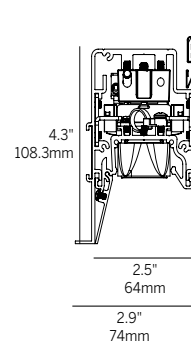

Recessed Elliptical Optic (REO)

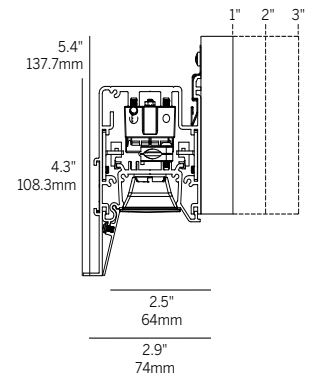

Soft Graze: 1" 2" 3" (SG1, SG2, SG3)

# ProTools 60 Linear Perimeter Recessed

Model	Fixation	Pattern	Length <sup>2</sup>	CRI/ CCT	Optic <sup>3</sup>	Beam	Power <sup>5</sup>	Driver <sup>6</sup>	Housing Finish <sup>7</sup>	Reflector Finish <sup>7</sup>	Options
WG-60PTLP	RPT	S	24	927	RML	80	P1	E1	W (std)	W	CP
WG-60PTLPSG1	RBT	PI <sup>1</sup>	48	930			P2	L1	B	B	EM
WG-60PTLPSG2	RGT9	PO <sup>1</sup>	96	935	RLW	35	P3	POE	S	S	NYC
WG-60PTLPSG3	RGT15 RGTS		XX <sup>3</sup>	940 TW <sup>4</sup>	RLB REO	50 20x40	P4	BT DALI TQ	F	F	TF

## Model

- WG-60PTLP = ProTools 60 Linear Perimeter
- WG-60PTLPSG1 = ProTools 60 Linear Perimeter Soft Graze 1" extension
- WG-60PTLPSG2 = ProTools 60 Linear Perimeter Soft Graze 2" extension
- WG-60PTLPSG3 = ProTools 60 Linear Perimeter Soft Graze 3" extension

## Fixation

- RPT = Recessed plaster trim
- RBT = Recessed trim for hard ceiling
- RGT9 = Recessed trim for 9/16" grid
- RGT15 = Recessed trim for 15/16" grid
- RGTS = Recessed trim for slot grid

## Pattern

- S = Straight run
- PI = Standard patterns 2, 3 or 4 sided with 90° inside corners on the same plane<sup>1</sup>
- PO = Standard patterns 2, 3 or 4 sided with 90° outside corners on the same plane<sup>1</sup>

## Length<sup>2</sup>

- 24 = 24"
- 48 = 48"
- 96 = 96"
- XX = Specify inches to the nearest 0.25"<sup>3</sup>

## CRI/CCT (90+ CRI)

- 927 = 2700K
- 930 = 3000K
- 935 = 3500K
- 940 = 4000K
- TW = Tuneable white 2200-4000K<sup>4</sup>

## Optic<sup>3</sup>

- RML = Recessed micro-prismatic lens
- RLW = Recessed louver white (supplied with white reflectors standard)
- RLB = Recessed louver black (supplied with black reflectors only)
- REO = Recessed elliptical optic

## Beam

- 80 = 80° (RML)
- 35 = 35° (RLW, RLB)
- 50 = 50° (RLW, RLB)
- 20x40 = 20x40° (REO)

## Power<sup>5</sup>

- P1 = 3W/ft
- P2 = 6W/ft
- P3 = 10W/ft
- P4 = 15W/ft

## Driver<sup>6</sup>

- E1 = EidoLED 0.1% dimming, 0-10V (120-277V)
- L1 = Lutron 1% dimming, Ecosystem (120-277V)
- PoE = Power over Ethernet
- BT = Wireless CAS – Casambi (Must specify BT with E1 or DALI)
- DALI = EidoLED Dali DT8 0.1% (120-277V)
- TQ = T-Series for Lutron Quantum 0.1% (120-277V) (Tunable white ONLY)

## Housing / Trim Finish<sup>7</sup>

- W = White, 15% gloss, RAL 9003 / Tiger Drylac 049/11350 (standard)
- B = Black, 15% gloss, RAL 9005 / Tiger Drylac 044/90053
- S = Silver, 15% gloss, RAL 9006 / Tiger Drylac 049/90500
- F = Custom finished trim, specify RAL

## Reflector Finish<sup>7</sup>

- W = White, 15% gloss, RAL 9003 / Tiger Drylac 049/11350 (standard with RLW)
- B = Black, 15% gloss, RAL 9005 / Tiger Drylac 044/90053 (standard with RLB)
- S = Silver, 15% gloss, RAL 9006 / Tiger Drylac 049/90500
- F = Custom finished trim, specify RAL

## Options

- CP = Chicago Plenum Rated
- EM = Emergency (remote)
- NYC = 6' whip per run
- TF = Top feed

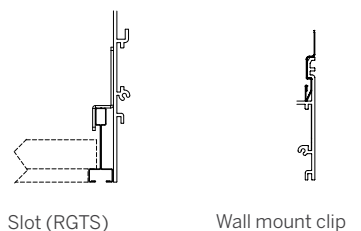
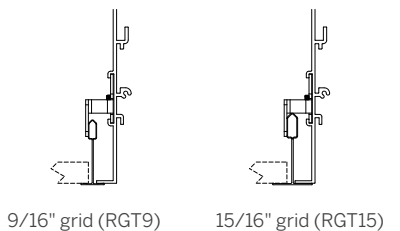
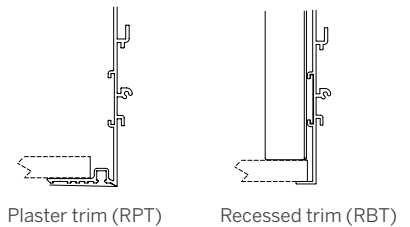

Whitegoods reserves the right to change any information without prior notice.

## Notes

- 1 See pattern spec sheet.
- 2 Individual fixture lengths less than 2' may require remote driver.
- 3 Specify Lensed products to nearest 0.25". Specify Louvered and Tuneable White products in 6" increments for continuous light. Louver supplied in 6" increments, balance of the run will have recessed blank covers on ends.
- 4 TW only available with RML for P2 and P3.
- 5 Refer to specsheets for delivered lumen data for all product configurations.
- 6 See power supply page for details.
- 7 See Tiger Drylac color chart: [inter-lux.com/tiger](http://inter-lux.com/tiger)

index

technical  
information



# ProTools 60 Linear Downlight

## Suspended

- 2.4" aperture, suspended direct illumination luminaire
- Standard and tailored run lengths, including corners
- Choice of beam spreads to accommodate all applications
- Extreme brightness control and the elimination of disturbing glare
- Modularity of insert modules for ultimate design flexibility
- Consistent LED technology throughout the Whitegoods product range
- Flexible design allows exact wall-to-wall dimensions
- Flicker-free full range dimming with standard driver (Eldoled)
- Manufactured in the USA



**Housing** Precision extruded aluminum for true dimensions and tolerances  
 Toolless component assembly from below  
 Field adjustable suspension height and position  
*Sure-lock* mechanical connection system eliminates light leak  
 Standard and tailored lengths including corner configurations  
 Recessed snap-in cover for non-illuminated section  
 Finishes: white, black, silver and custom  
 Clear suspension cables with white ceiling escutcheons standard

**Integration** Ceiling canopy mounts to any ceiling surface

**Distribution** 30, 35, 50, 80, 105 degree symmetrical downlight  
 Wall Wash

**LED** >90 CRI, 3-Step MacAdam, 2700-4000K static white  
 3W - 15W per foot, 180 nominal lumens per watt average  
 RA 91-94 (2700-4000K)  
 L70 (TM21 Projected 85C) Static White / Tunable White = 72,000 hours  
 Tuneable white 2200-4000K, 80 nominal lumens per watt average

**Optic** RML - recessed micro-prismatic lens | diffusion with maximum efficiency  
 ROL - regressed opal acrylic lens | evenly illuminated line of light  
 RLW/RLB - recessed louver white (W) or black (B) | extreme cutoff  
 RNO - recessed narrow optic | narrow beam with maximum punch  
 LML - Linear micro-prismatic lens - diffusion and efficiency for wall wash

**Reflector** White: high efficiency (standard with RLW)  
 Black: no brightness (standard with RLB, not offered with LML)  
 Silver: low brightness  
 All 15% gloss  
 Custom finish available

**Driver** Compatible with quality constant current drivers

**Connectivity** POE  
 Wireless

**Weight** 4lbs per foot

**Operating Temp** Suitable for operation in maximum ambient temperature of 35C (95F)

**Warranty** 5-year Limited (see complete company warranty information)

**Certifications** ETL and ETL-C for dry and damp location, CE

**Voltages** 120-277VAC

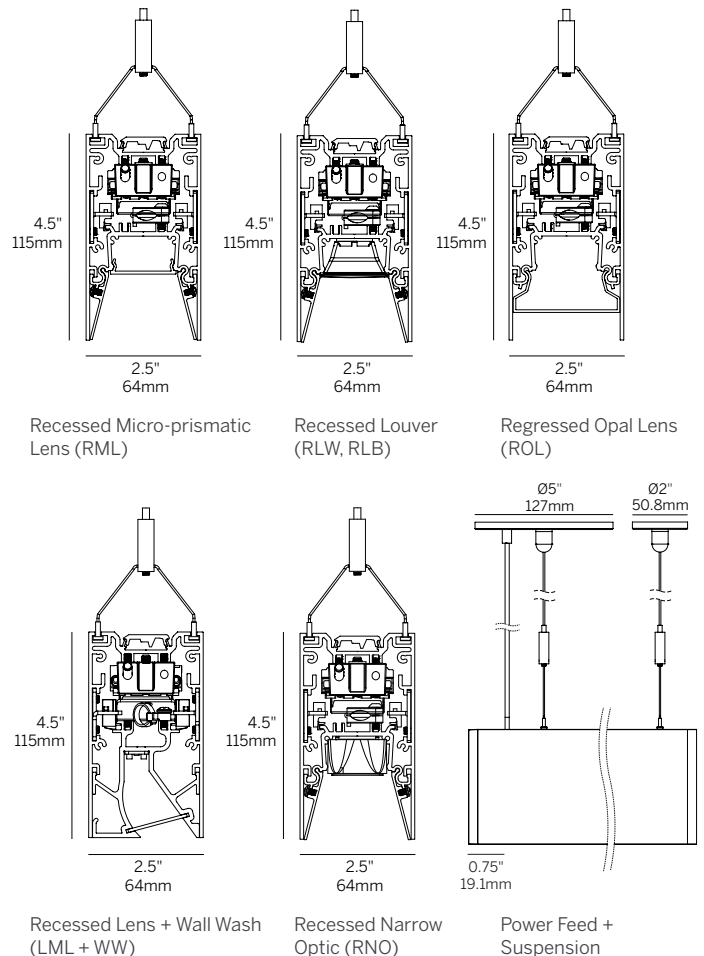
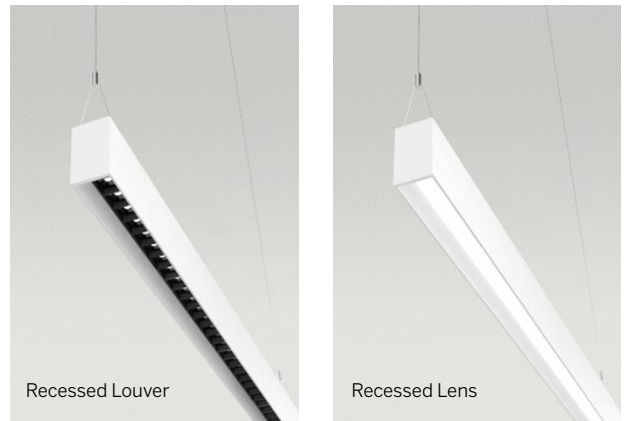

# ProTools 60 Linear Downlight

## Suspended

Model	Fixation	Pattern	Length <sup>2</sup>	CRI/CCT	Optic <sup>3</sup>	Beam	Power <sup>5</sup>	Drive <sup>6</sup>	Housing Finish <sup>7</sup>	Reflector Finish <sup>7</sup>	Options
WG-60PTL	S48	S	24	927	RML	80	P1	E1	W (std)	W	EM
	S96	P	48	930	ROL	105	P2	L1	B	B	PJG
	SXX	PI <sup>1</sup>	96	935	RLW	35	P3	POE	S	S	SC
		PO <sup>1</sup>	XX <sup>3</sup>	940	RLB	50	P4	BT	F	F	
	PZ <sup>1</sup>		TW <sup>4</sup>	RNO	30		DALI				
				LML	WW		TQ				

### Model

- WG-60PTL = ProTools 60 Linear Downlight

### Fixation

Power suspension w/5" canopy standard. Non-feed suspensions provided with 2" canopy

- S48 = 48" suspension cable
- S96 = 96" suspension cable
- SXX = Specify suspension cable length to nearest 0.25

### Pattern

- S = Straight run
- P = Standard patterns 2, 3 or 4 sided with 90° corners on the same plane<sup>1</sup>
- PI = Standard patterns 2, 3 or 4 sided with 90° inside corners on the same plane<sup>1</sup>
- PO = Standard patterns 2, 3 or 4 sided with 90° outside corners on the same plane<sup>1</sup>
- PZ = Non-standard patterns and/or corners other than 90° on multiple planes, consult factory<sup>1</sup>

### Length<sup>2</sup>

- 24 = 24"
- 48 = 48"
- 96 = 96"
- XX = Specify inches to the nearest 0.25"<sup>3</sup>

### CRI/CCT (90+ CRI)

- 927 = 2700K
- 930 = 3000K
- 935 = 3500K
- 940 = 4000K
- TW = Tuneable white 2200-4000K<sup>4</sup>

### Optic<sup>3</sup>

- RML = Recessed micro-prismatic lens
- ROL = Regressed opal lens
- RLW = Recessed louver white (supplied with white reflectors standard)
- RLB = Recessed louver black (supplied with black reflectors only)
- RNO = Recessed narrow optic
- LML = Linear micro-prismatic lens

### Beam

- 80 = 80° (RML)
- 105 = 105° (ROL)
- 35 = 35° (RLW, RLB)
- 50 = 50° (RLW, RLB)
- 30 = 30° (RNO)
- WW = Wall Wash (LML)

### Power<sup>5</sup>

- P1 = 3W/ft
- P2 = 6W/ft
- P3 = 10W/ft
- P4 = 15W/ft

### Driver<sup>6</sup>

- E1 = EldoLED 0.1% dimming, 0-10V (120-277V)
- L1 = Lutron 1% dimming, Ecosystem (120-277V)
- PoE = Power over Ethernet
- BT = Wireless CAS – Casambi (Must specify BT with E1 or DALI)
- DALI = EldoLED Dali DT8 0.1% (120-277V)
- TQ = T-Series for Lutron Quantum 0.1% (120-277V) (Tunable white ONLY)

### Housing Finish<sup>7</sup>

- W = White, 15% gloss, RAL 9003 / Tiger Drylac 049/11350 (standard)
- B = Black, 15% gloss, RAL 9005 / Tiger Drylac 044/90053
- S = Silver, 15% gloss, RAL 9006 / Tiger Drylac 049/90500
- F = Custom finished trim, specify RAL

### Reflector Finish<sup>7</sup>

- W = White, 15% gloss, RAL 9003 / Tiger Drylac 049/11350 (standard with RLW)
- B = Black, 15% gloss, RAL 9005 / Tiger Drylac 044/90053 (standard with RLB, not offered with LML)
- S = Silver, 15% gloss, RAL 9006 / Tiger Drylac 049/90500
- F = Custom finished trim, specify RAL

### Options

- EM = Emergency (remote)
- PJG = Power suspension w/5" canopy on grid
- SC = Sloped ceiling suspension

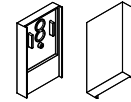

End Caps  
(2 included  
per run)

Whitegoods reserves the right to change any information without prior notice.

### Notes

- See pattern spec sheet.
- Individual fixture lengths less than 2' may require remote driver.
- Specify Lensed products to nearest 0.25". Specify Louvered and Tuneable White products in 6" increments for continuous light. Louver supplied in 6" increments, balance of the run will have recessed blank covers on ends.
- TW only available with RML/ROL/LML for P2 and P3.
- Refer to specsheet for delivered lumen data for all product configurations.
- See power supply page for details.
- See Tiger Drylac color chart: [inter-lux.com/tiger](http://inter-lux.com/tiger)

index

technical  
information



# ProTools 60 Linear Direct/Indirect Suspended

- 2.4" aperture, suspended bi-directional luminaire
- Standard and tailored run lengths, including corner configurations
- Separately controllable up and down lighting with distribution options
- Choice of beam spreads to accommodate all applications
- Extreme brightness control and the elimination of disturbing glare
- Modularity of insert modules for ultimate design flexibility
- Consistent LED technology throughout the Whitegoods product range
- Flicker-free full range dimming with standard driver (Eldoled)
- Manufactured in the USA

**Housing** Precision extruded aluminum for true dimensions and tolerances  
Toolless component assembly  
Field adjustable suspension height and position  
*Sure-lock* mechanical connection system eliminates light leak  
Standard and tailored lengths and corner configurations  
Recessed snap-in cover for non-illuminated section  
Finishes: white, black, silver and custom  
Clear suspension cables with white ceiling escutcheons standard

**Integration** Ceiling canopy mounts to any ceiling surface

**Distribution** 30, 35, 50, 80, 105 degree symmetrical downlight  
Batwing and asymmetric uplight options  
Wall Wash

**LED** >90 CRI, 3-Step MacAdam, 2700-4000K static white  
3W - 15W per foot, 180 nominal lumens per watt average  
RA 91-94 (2700-4000K)  
L70 (TM21 Projected 85C) Static White / Tunable White = 72,000 hours  
Tunable white 2200-4000K, 80 nominal lumens per watt average

**Optic** RML - recessed micro-prismatic lens | diffusion with maximum efficiency  
ROL - regressed opal acrylic lens | evenly illuminated line of light  
RLW/RLB - recessed louver white (W) or black (B) | extreme cutoff  
RNO - recessed narrow optic | narrow beam with maximum punch  
LML - Linear micro-prismatic lens - diffusion and efficiency for wall wash  
A/W - Snap-on acrylic uplight optic - batwing or asymmetric distribution

**Reflector** White: high efficiency (standard with RLW)  
Black: no brightness (standard with RLB, not offered with LML)  
Silver: low brightness  
All 15% gloss  
Custom finish available

**Driver** Compatible with quality constant current drivers

**Connectivity** POE  
Wireless

**Weight** 4lbs per foot

**Operating Temp** Suitable for operation in maximum ambient temperature of 35C (95F)

**Warranty** 5-year Limited (see complete company warranty information)

**Certifications** ETL and ETL-C for dry and damp location, CE

**Voltages** 120-277VAC

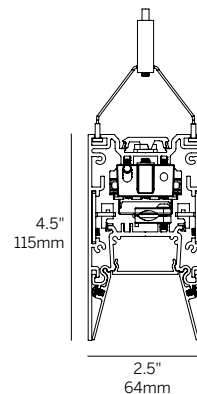

Recessed Micro-prismatic Lens (RML)

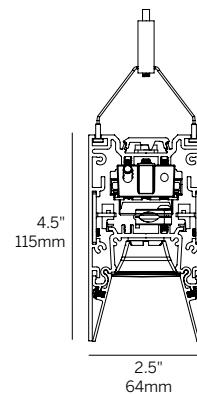

Recessed Louver (RLW, RLB)

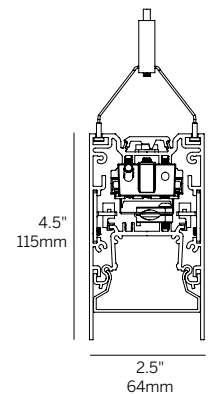

Regressed Opal Lens (ROL)

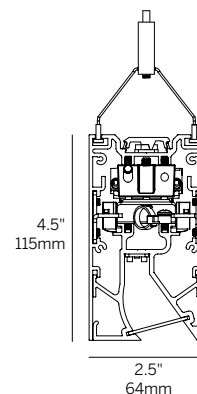

Recessed Lens + Wall Wash (LML + WW)

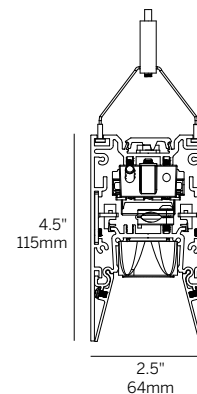

Recessed Narrow Optic (RNO)

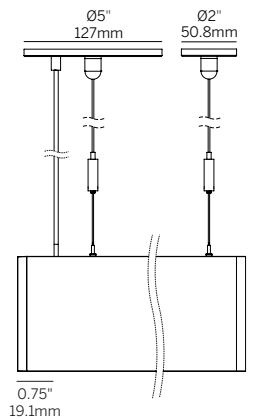

Power Feed + Suspension

# ProTools 60 Linear Direct/Indirect Suspended

Model <sup>1</sup>	Fixation	Pattern	Length <sup>3</sup>	CRI/ CCT	Direct			Indirect		Driver <sup>7</sup>	Housing Finish <sup>8</sup>	Reflector Finish <sup>8</sup>	Options
					Optic <sup>4</sup>	Beam	Power <sup>6</sup>	Optic	Power <sup>6</sup>				
WG-60PTLDI	S48 S96 SXX	S P <sup>2</sup> PI <sup>2</sup> PO <sup>2</sup> PZ <sup>2</sup>	24 48 96 XX <sup>4</sup>	927 930 935 940 TW <sup>5</sup>	RML	80	P1	A	P1	E1 L1 POE BT DALI TQ	W (std) B S F	W B S F	DC EM PJG SC
					ROL	105	P2 P3 P4	W	P2				
					RLW	35							
					RLB	50							
					RNO	30							
					LML	WW							

## Model<sup>1</sup>

- WG-60PTLDI = ProTools 60 Linear Direct/Indirect

## Fixation

Power suspension w/5" canopy standard. Non-feed suspensions provided with 2" canopy

- S48 = 48" suspension cable
- S96 = 96" suspension cable
- SXX = Specify suspension cable length to nearest 0.25

## Pattern

- S = Straight run
- P = Standard patterns 2, 3 or 4 sided with 90° corners on the same plane<sup>1</sup>
- PI = Standard patterns 2, 3 or 4 sided with 90° inside corners on the same plane<sup>1</sup>
- PO = Standard patterns 2, 3 or 4 sided with 90° outside corners on the same plane<sup>1</sup>
- PZ = Non-standard patterns and/or corners other than 90° on multiple planes, consult factory<sup>2</sup>

## Length<sup>3</sup>

- 24 = 24"
- 48 = 48"
- 96 = 96"
- XX = Specify inches to the nearest 0.25"<sup>4</sup>

## CRI/CCT (90+ CRI)

- 927 = 2700K
- 930 = 3000K
- 935 = 3500K
- 940 = 4000K
- TW = Tuneable white 2200-4000K<sup>5</sup>

## Optic Direct<sup>4</sup>

- RML = Recessed micro-prismatic lens
- ROL = Regressed opal lens
- RLW = Recessed louver white (supplied with white reflectors standard)
- RLB = Recessed louver black (supplied with black reflectors only)
- RNO = Recessed narrow optic
- LML = Linear micro-prismatic lens

## Optic Indirect

- A = Asymmetric
- W = Wide (batwing)

## Beam

- 80 = 80° (RML)
- 105 = 105° (ROL)
- 35 = 35° (RLW, RLB)
- 50 = 50° (RLW, RLB)
- 30 = 30° (RNO)
- WW = Wall Wash (LML)

## Power Direct<sup>6</sup>

- P1 = 3W/ft
- P2 = 6W/ft
- P3 = 10W/ft
- P4 = 15W/ft

## Power Indirect Lens (W/A)<sup>6</sup>

- P1 = 3W/ft
- P2 = 6W/ft

## Driver<sup>7</sup>

- E1 = EldoLED 0.1% dimming, 0-10V (120-277V)
- L1 = Lutron 1% dimming, Ecosystem (120-277V)
- PoE = Power over Ethernet
- BT = Wireless CAS – Casambi (Must specify BT with E1 or DALI)
- DALI = EldoLED Dali DT8 0.1% (120-277V)
- TQ = T-Series for Lutron Quantum 0.1% (120-277V) (Tunable white ONLY)

## Housing Finish<sup>8</sup>

- W = White, 15% gloss, RAL 9003 / Tiger Drylac 049/11350 (standard)
- B = Black, 15% gloss, RAL 9005 / Tiger Drylac 044/90053
- S = Silver, 15% gloss, RAL 9006 / Tiger Drylac 049/90500
- F = Custom finished trim, specify RAL

## Reflector Finish<sup>8</sup>

- W = White, 15% gloss, RAL 9003 / Tiger Drylac 49/11350 (standard with RLW)
- B = Black, 15% gloss, RAL 9005 / Tiger Drylac 44/90053 (standard with RLB, not offered with LML)
- S = Silver, 15% gloss, RAL 9006 / Tiger Drylac 049/90500
- F = Custom finished trim, specify RAL

## Options

- DC = Dual circuit
- EM = Emergency (remote)
- PJG = Power suspension w/5" canopy on grid
- SC = Sloped ceiling suspension

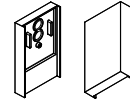

End Caps  
(2 included  
per run)

Whitegoods reserves the right to change any information without prior notice.

## Notes

- To specify Indirect only, leave direct (optic, beam, power) codes blank.
- See pattern spec sheet.
- Individual fixture lengths less than 2' may require remote driver.
- Specify Lensed products to nearest 0.25". Specify Louvered and Tuneable White products in 6" increments for continuous light. Louver supplied in 6" increments, balance of the run will have recessed blank covers on ends.
- TW only available with RML/ROL/LML for P2 and P3.
- Refer to specsheet for delivered lumen data for all product configurations.
- See power supply page for details.
- See Tiger Drylac color chart: [inter-lux.com/tiger](http://inter-lux.com/tiger)

index

technical  
information



# ProTools 60 Linear Downlight

## Surface Mount

- 2.4" aperture, integrated solution that is compatible with all ceiling types
- Standard and tailored run lengths, including corners
- Downlight, Wall Wash and wall graze distribution for ceiling heights to 30'
- Modularity of insert modules for ultimate design flexibility
- Extreme brightness control eliminates disturbing glare
- Consistent LED technology throughout the Whitegoods product range
- Flexible design allows exact wall-to-wall dimensions
- Flicker-free full range dimming with standard driver (Eldoled)
- Manufactured in the USA

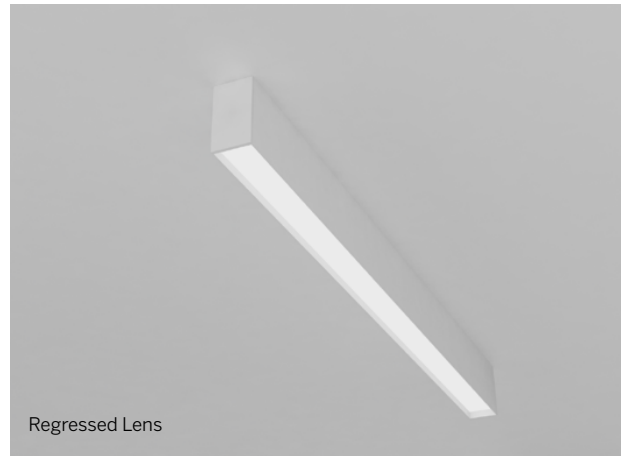

**Housing** Precision extruded aluminum for true dimensions and tolerances  
 Toolless component assembly from below  
 Perfect fit with inserts, louvers and lenses  
*Sure-lock* mechanical connection system eliminates light leak  
 Standard and tailored lengths including corner configurations  
 Recessed snap-in cover for non-illuminated section  
 Finishes: white, black, silver and custom

**Integration** Fixation onto any surface type  
 End wall mechanical and power connection option

**Distribution** 35, 50, 80, 105 degree symmetrical downlight  
 Wall Wash

**LED** >90 CRI, 3-Step MacAdam, 2700-4000K static white  
 3W - 15W per foot, 180 nominal lumens per watt average  
 RA 91-94 (2700-4000K)  
 L70 (TM21 Projected 85C) Static White / Tunable White = 72,000 hours  
 Tuneable white 2200-4000K, 80 nominal lumens per watt average

**Optic** RML - recessed micro-prismatic lens | diffusion with maximum efficiency  
 ROL - regressed opal acrylic lens | evenly illuminated line of light  
 RLW/RLB - recessed louver white (W) or black (B) | extreme cutoff  
 REO - Recessed elliptical optic - high efficiency graze  
 LML - Linear micro-prismatic lens - diffusion and efficiency for wall wash

**Reflector** White: high efficiency (standard with RLW)  
 Black: no brightness (standard with RLB, not offered with LML)  
 Silver: low brightness  
 All 15% gloss  
 Custom finish available

**Driver** Compatible with quality constant current drivers

**Connectivity** POE  
 Wireless

**Weight** 4lbs per foot

**Operating Temp** Suitable for operation in maximum ambient temperature of 35C (95F)

**Warranty** 5-year Limited (see complete company warranty information)

**Certifications** ETL and ETL-C for dry and damp location, CE, Chicago plenum

**Voltages** 120-277VAC

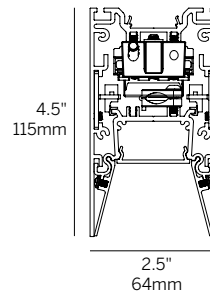

Recessed Micro-prismatic Lens (RML)

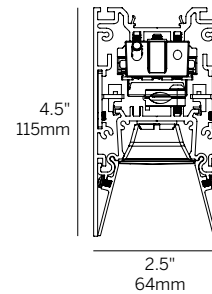

Recessed Louver (RLW, RLB)

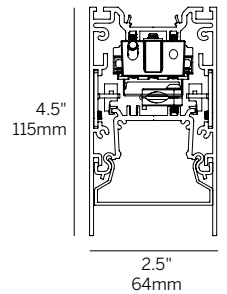

Regressed Opal Lens (ROL)

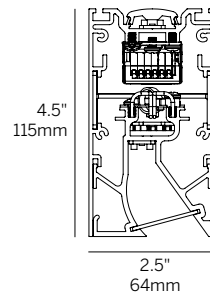

Recessed Lens + Wall Wash (LML + WW)

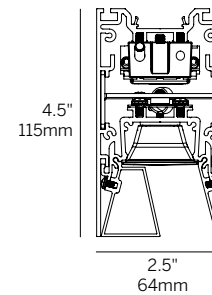

Recessed Louver + Wall Graze (RLW, RLB + WG)

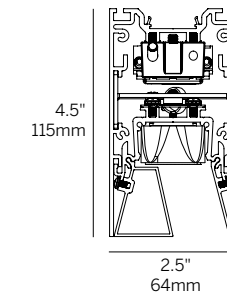

Recessed Elliptical Optic + Wall Graze (REO + WG)



# ProTools 60 Linear Downlight

## Surface Mount

Model	Fixation	Pattern	Length <sup>2</sup>	CRI/CCT	Optic <sup>3</sup>	Beam	Power <sup>5</sup>	Driver <sup>6</sup>	Housing Finish <sup>7</sup>	Reflector Finish <sup>7</sup>	Options
WG-60PTL	SM	S	24	927	RML	80	P1	E1	W (std)	W	EM
		P <sup>1</sup>	48	930	ROL	105	P2	L1	B	B	EW
		PPI <sup>1</sup>	96	935			P3	POE	S	S	EWP
		PPO <sup>1</sup>	XX <sup>3</sup>	940	RLW	35	P4	BT	F	F	
		PI <sup>1</sup>		TW <sup>4</sup>	50			DALI			
PO <sup>1</sup>			REO	WG		TQ					
		PZ <sup>1</sup>			LML	WW					

### Model

- WG-60PTL = ProTools 60 Linear Downlight

### Fixation

- SM = Surface Mount

### Pattern

- S = Straight run
- P = Standard patterns 2, 3 or 4 sided with 90° corners on the same plane<sup>1</sup>
- PPI = Pattern, Plane to Plane, Inside. 2-3-4 sided pattern with inside corners
- PPO = Pattern, Plane to Plane, Outside. 2-3-4 sided pattern with outside corners
- PI = Standard patterns 2, 3 or 4 sided with 90° inside corners on the same plane<sup>1</sup>
- PO = Standard patterns 2, 3 or 4 sided with 90° outside corners on the same plane<sup>1</sup>
- PZ = Non-standard patterns and/or corners other than 90° on multiple planes, consult factory<sup>1</sup>

### Length<sup>2</sup>

- 24 = 24"
- 48 = 48"
- 96 = 96"
- XX = Specify inches to the nearest 0.25"<sup>3</sup>

### CRI/CCT (90+ CRI)

- 927 = 2700K
- 930 = 3000K
- 935 = 3500K
- 940 = 4000K
- TW = Tuneable white 2200-4000K<sup>4</sup>

### Optic<sup>3</sup>

- RML = Recessed micro-prismatic lens
- ROL = Regressed opal lens
- RLW = Recessed louver white (supplied with white reflectors standard)
- RLB = Recessed louver black (supplied with black reflectors only)
- REO = Recessed elliptical optic
- LML = Linear micro-prismatic lens

### Beam

- 80 = 80° (RML)
- 105 = 105° (ROL)
- 35 = 35° (RLW, RLB)
- 50 = 50° (RLW, RLB)
- WW = Wall Wash (LML)
- WG = Wall Graze (RLW, RLB, REO)

### Power<sup>5</sup>

- P1 = 3W/ft
- P2 = 6W/ft
- P3 = 10W/ft
- P4 = 15W/ft

### Driver<sup>6</sup>

- E1 = EdoLED 0.1% dimming, 0-10V (120-277V)
- L1 = Lutron 1% dimming, Ecosystem (120-277V)
- PoE = Power over Ethernet
- BT = Wireless CAS – Casambi (Must specify BT with E1 or DALI)
- DALI = EdoLED Dali DT8 0.1% (120-277V)
- TQ = T-Series for Lutron Quantum 0.1% (120-277V) (Tunable white ONLY)

### Housing Finish<sup>7</sup>

- W = White, 15% gloss, RAL 9003 / Tiger Drylac 049/11350 (standard)
- B = Black, 15% gloss, RAL 9005 / Tiger Drylac 044/90053
- S = Silver, 15% gloss, RAL 9006 / Tiger Drylac 049/90500
- F = Custom finished trim, specify RAL

### Reflector Finish<sup>7</sup>

- W = White, 15% gloss, RAL 9003 / Tiger Drylac 49/11350 (standard with RLW)
- B = Black, 15% gloss, RAL 9005 / Tiger Drylac 44/90053 (standard with RLB, not offered with LML)
- S = Silver, 15% gloss, RAL 9006 / Tiger Drylac 049/90500
- F = Custom finished trim, specify RAL

### Options

- EM = Emergency (remote)
- EW = End wall bracket
- EWP = End wall power bracket

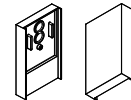

End Caps  
(2 included  
per run)

Whitegoods reserves the right to change any information without prior notice.

### Notes

- See pattern spec sheet.
- Individual fixture lengths less than 2' may require remote driver.
- Specify Lensed products to nearest 0.25". Specify Louvered and Tuneable White products in 6" increments for continuous light. Louver supplied in 6" increments, balance of the run will have recessed blank covers on ends. REO only available with WG.
- TW only available with RML/ROL/LML for P2 and P3.
- Refer to specsheet for delivered lumen data for all product configurations.
- See power supply page for details.
- See Tiger Drylac color chart: [inter-lux.com/tiger](http://inter-lux.com/tiger)

index

technical  
information



# ProTools 60 Linear Downlight

## 6" / 12" Surface Mount

- 2.4" aperture, integrated solution that is compatible with all ceiling types
- Standard and tailored run lengths, including corners
- Downlight, Wall Wash and wall graze distribution
- Modularity of insert modules for ultimate design flexibility
- Extreme brightness control eliminates disturbing glare
- Consistent LED technology throughout the Whitegoods product range
- Flexible design allows exact wall-to-wall dimensions
- Flicker-free full range dimming with standard driver (Eldoled)
- Manufactured in the USA

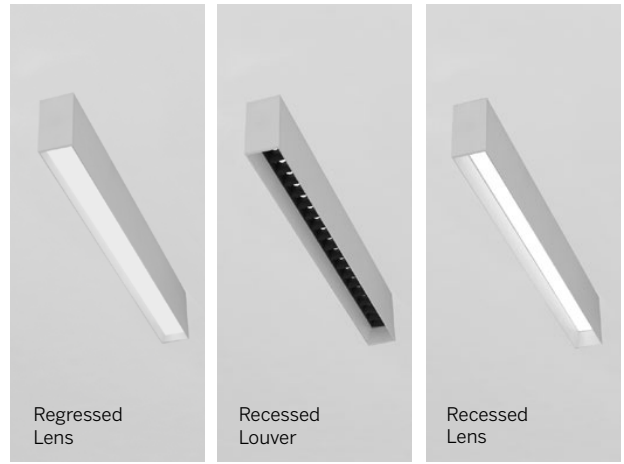

**Housing** Precision extruded aluminum for true dimensions and tolerances  
 Toolless component assembly from below  
 Perfect fit with inserts, louvers and lenses  
*Sure-lock* mechanical connection system eliminates light leak  
 Standard and tailored lengths including corner configurations  
 Recessed snap-in cover for non-illuminated section  
 Finishes: white, black, silver and custom

**Integration** Fixation onto any surface type  
 End wall mechanical and power connection option

**Distribution** 35, 50, 80, 105 degree symmetrical downlight  
 Wall Wash

**LED** >90 CRI, 3-Step MacAdam, 2700-4000K static white  
 3W - 15W per foot, 180 nominal lumens per watt average  
 RA 91-94 (2700-4000K)  
 L70 (TM21 Projected 85C) Static White / Tunable White = 72,000 hours  
 Tuneable white 2200-4000K, 80 nominal lumens per watt average

**Optic** RML - recessed micro-prismatic lens | diffusion with maximum efficiency  
 ROL - regressed opal acrylic lens | evenly illuminated line of light  
 RLW/RLB - recessed louver white (W) or black (B) | extreme cutoff  
 LML - Linear micro-prismatic lens - diffusion and efficiency for wall wash

**Reflector** White: high efficiency (standard with RLW)  
 Black: no brightness (standard with RLB, not offered with LML)  
 Silver: low brightness  
 All 15% gloss  
 Custom finish available

**Driver** Compatible with quality constant current drivers

**Connectivity** POE  
 Wireless

**Weight** 4lbs per foot

**Operating Temp** Suitable for operation in maximum ambient temperature of 35C (95F)

**Warranty** 5-year Limited (see complete company warranty information)

**Certifications** ETL and ETL-C for dry and damp location, CE, Chicago plenum

**Voltages** 120-277VAC

Recessed Micro-prismatic Lens (RML)

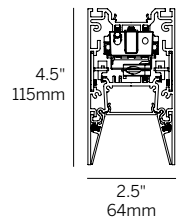
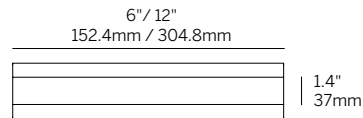

Regressed Opal Lens (ROL)

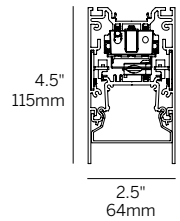
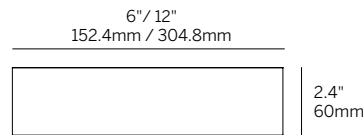

Recessed Louver (RLW, RLB)

Recessed Louver (RLW, RLB)

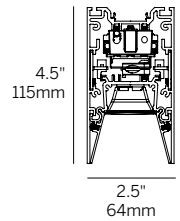
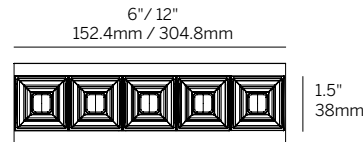

Recessed Lens + Wall Wash (LML + WW)

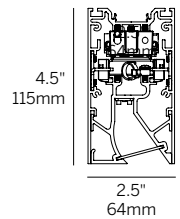
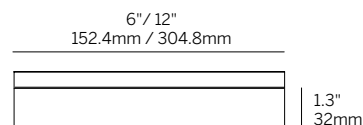

# ProTools 60 Linear Downlight

## 6" / 12" Surface Mount

Model	Fixation	Pattern	Length <sup>2</sup>	CRI/CCT	Optic <sup>3</sup>	Beam	Power <sup>5</sup>	Driver <sup>6</sup>	Housing Finish <sup>7</sup>	Reflector Finish <sup>7</sup>	Options
WG-60PTL	SM	S	6 12	927	RML	80	P1	E1	W (std)	W	EM EW EWP
				930	ROL	105	P2	L1	B	B	
				935	RLW	35	P3	POE	S	S	
				940	RLB	50	P4	BT	F	F	
				TW <sup>4</sup>	LML	WW		TQ			

### Model

- WG-60PTL = ProTools 60 Linear Downlight 6" / 12" Recessed

### Fixation

- SM = Surface Mount

### Pattern

- S = Straight run

### Length<sup>2</sup>

- 6 = 6"
- 12 = 12"

### CRI/CCT (90+ CRI)

- 927 = 2700K
- 930 = 3000K
- 935 = 3500K
- 940 = 4000K
- TW = Tuneable white 2200-4000K<sup>4</sup>

### Optic<sup>3</sup>

- RML = Recessed micro-prismatic lens
- ROL = Regressed opal lens
- RLW = Recessed louver white (supplied with white reflectors standard)
- RLB = Recessed louver black (supplied with black reflectors only)
- LML = Linear micro-prismatic lens

### Beam

- 80 = 80° (RML)
- 105 = 105° (ROL)
- 35 = 35° (RLW, RLB)
- 50 = 50° (RLW, RLB)
- WW = Wall Wash (LML)

### Power<sup>5</sup>

- P1 = 3W/ft
- P2 = 6W/ft
- P3 = 10W/ft
- P4 = 15W/ft

### Driver (Remote)<sup>6</sup>

- E1 = EldoLED 0.1% dimming, 0-10V (120-277V)
- L1 = Lutron 1% dimming, Ecosystem (120-277V)
- PoE = Power over Ethernet
- BT = Wireless CAS – Casambi (Must specify BT with E1 or DALI)
- DALI = EldoLED Dali DT8 0.1% (120-277V)
- TQ = T-Series for Lutron Quantum 0.1% (120-277V) (Tunable white ONLY)

### Housing Finish<sup>7</sup>

- W = White, 15% gloss, RAL 9003 / Tiger Drylac 049/11350 (standard)
- B = Black, 15% gloss, RAL 9005 / Tiger Drylac 044/90053
- S = Silver, 15% gloss, RAL 9006 / Tiger Drylac 049/90500
- F = Custom finished trim, specify RAL

### Reflector Finish<sup>7</sup>

- W = White, 15% gloss, RAL 9003 / Tiger Drylac 49/11350 (standard with RLW)
- B = Black, 15% gloss, RAL 9005 / Tiger Drylac 44/90053 (standard with RLB, not offered with LML)
- S = Silver, 15% gloss, RAL 9006 / Tiger Drylac 049/90500
- F = Custom finished trim, specify RAL

### Options

- EM = Emergency (remote)
- EW = End wall bracket
- EWP = End wall power bracket

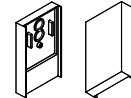

End Caps  
(2 included  
per run)

Whitegoods reserves the right to change any information without prior notice.

### Notes

- See pattern spec sheet.
- Individual fixture lengths less than 2' may require remote driver.
- Specify Lensed products to nearest 0.25". Specify Louvered and Tuneable White products in 6" increments for continuous light. Louver supplied in 6" increments, balance of the run will have recessed blank covers on ends. REO only available with WG.
- TW only available with RML/ROL/LML for P2 and P3.
- Refer to specsheet for delivered lumen data for all product configurations.
- See power supply page for details.
- See Tiger Drylac color chart: [inter-lux.com/tiger](http://inter-lux.com/tiger)

index

technical  
information



# ProTools 60 Linear Downlight

## Wall / Mullion Mount

- 2.4" aperture, wall mount downlight with multiple distributions
- Specialized mounting bracket to mount directly to 2.5" window mullion
- Standard and tailored run lengths, including corners
- Modularity of insert modules for ultimate design flexibility
- Extreme brightness control eliminates disturbing glare
- Consistent LED technology throughout the Whitegoods product range
- Flexible design allows exact wall-to-wall dimensions
- Flicker-free full range dimming with standard driver (Eldoled)
- Manufactured in the USA

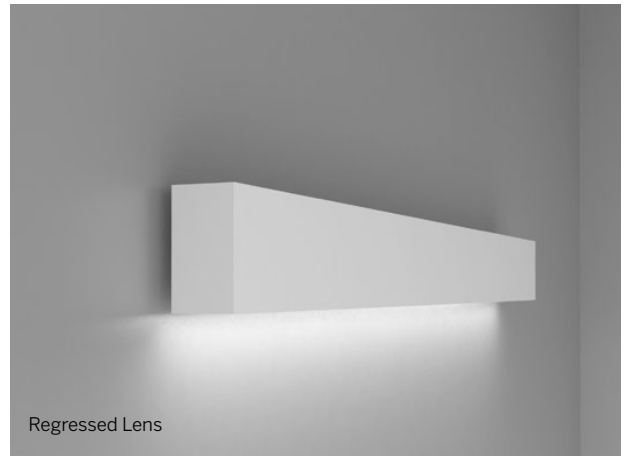

**Housing** Precision extruded aluminum for true dimensions and tolerances  
 Toolless component assembly from below  
 Mounts to horizontal 2" x 4" box or direct to the mounting surface  
*Sure-lock* mechanical connection system eliminates light leak  
 Standard and tailored lengths including corner configurations  
 Recessed snap-in cover for non-illuminated section  
 Finishes: white, black, silver and custom

**Integration** Wall and mullion mounting brackets  
 End wall mechanical and power connection option

**Distribution** 35, 50, 80, 105, 20x40 degree symmetrical downlight

**LED** >90 CRI, 3-Step MacAdam, 2700-4000K static white  
 3W - 15W per foot, 180 nominal lumens per watt average  
 RA 91-94 (2700-4000K)  
 L70 (TM21 Projected 85C) Static White / Tunable White = 72,000 hours  
 Tuneable white 2200-4000K, 80 nominal lumens per watt average



**Optic** RML - recessed micro-prismatic lens | diffusion with maximum efficiency  
 ROL - regressed opal acrylic lens | evenly illuminated line of light  
 RLW/RLB - recessed louver white (W) or black (B) | extreme cutoff  
 REO - Recessed elliptical optic - high efficiency graze

**Reflector** White: high efficiency (standard with RLW)  
 Black: no brightness (standard with RLB)  
 Silver: low brightness  
 All 15% gloss  
 Custom finish available

**Driver** Compatible with quality constant current drivers

**Connectivity** POE  
 Wireless

**Weight** 4lbs per foot

**Operating Temp** Suitable for operation in maximum ambient temperature of 35C (95F)

**Warranty** 5-year Limited (see complete company warranty information)

**Certifications** ETL and ETL-C for dry and damp location, CE

**Voltages** 120-277VAC

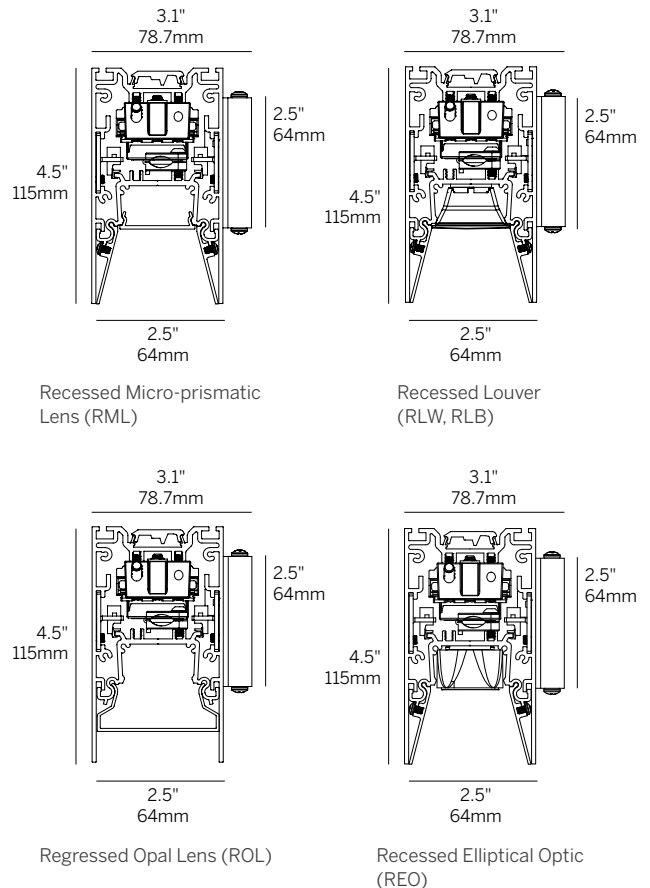

# ProTools 60 Linear Downlight

## Wall / Mullion Mount

Model	Fixation	Pattern	Length <sup>2</sup>	CRI/CCT	Optic <sup>3</sup>	Beam	Power <sup>5</sup>	Driver <sup>6</sup>	Housing Finish <sup>7</sup>	Reflector Finish <sup>7</sup>	Options
WG-60PTL	SW SWM	S PI <sup>1</sup> PO <sup>1</sup>	24	927	RML	80	P1	E1	W (std)	W	EM EW
			48	930	ROL	105	P2	L1	B	B	
			96	935	RLW	35	P3	POE	S	S	
			XX <sup>3</sup>	940	RLB	50	P4	BT	F	F	
				TW <sup>4</sup>	REO	20x40					

### Model

- WG-60PTL = ProTools 60 Linear Downlight

### Fixation

- SW = Surface Wall Mount
- SWM = Surface Wall Mullion Mount

### Pattern

- S = Straight run
- PI = Standard patterns 2, 3 or 4 sided with 90° inside corners on the same plane<sup>1</sup>
- PO = Standard patterns 2, 3 or 4 sided with 90° outside corners on the same plane<sup>1</sup>

### Length<sup>2</sup>

- 24 = 24"
- 48 = 48"
- 96 = 96"
- XX = Specify inches to the nearest 0.25"<sup>3</sup>

### CRI/CCT (90+ CRI)

- 927 = 2700K
- 930 = 3000K
- 935 = 3500K
- 940 = 4000K
- TW = Tuneable white 2200-4000K<sup>4</sup>

### Optic<sup>3</sup>

- RML = Recessed micro-prismatic lens
- ROL = Regressed opal lens
- RLW = Recessed louver white (supplied with white reflectors standard)
- RLB = Recessed louver black (supplied with black reflectors only)
- REO = Recessed elliptical optic

### Beam

- 80 = 80° (RML)
- 105 = 105° (ROL)
- 35 = 35° (RLW, RLB)
- 50 = 50° (RLW, RLB)
- 20x40 = 20x40° (REO)

### Power<sup>5</sup>

- P1 = 3W/ft
- P2 = 6W/ft
- P3 = 10W/ft
- P4 = 15W/ft

### Driver<sup>6</sup>

- E1 = EldoLED 0.1% dimming, 0-10V (120-277V)
- L1 = Lutron 1% dimming, Ecosystem (120-277V)
- PoE = Power over Ethernet
- BT = Wireless CAS – Casambi (Must specify BT with E1 or DALI)
- DALI = EldoLED Dali DT8 0.1% (120-277V)
- TQ = T-Series for Lutron Quantum 0.1% (120-277V) (Tunable white ONLY)

### Housing Finish<sup>7</sup>

- W = White, 15% gloss, RAL 9003 / Tiger Drylac 049/11350 (standard)
- B = Black, 15% gloss, RAL 9005 / Tiger Drylac 044/90053
- S = Silver, 15% gloss, RAL 9006 / Tiger Drylac 049/90500
- F = Custom finished trim, specify RAL

### Reflector Finish<sup>7</sup>

- W = White, 15% gloss, RAL 9003 / Tiger Drylac 049/11350 (standard with RLW)
- B = Black, 15% gloss, RAL 9005 / Tiger Drylac 044/90053 (standard with RLB)
- S = Silver, 15% gloss, RAL 9006 / Tiger Drylac 049/90500
- F = Custom finished trim, specify RAL

### Options

- EM = Emergency (remote)
- EW = End wall bracket

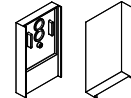

End Caps  
(2 included  
per run)

Whitegoods reserves the right to change any information without prior notice.

### Notes

- See pattern spec sheet.
- Individual fixture lengths less than 2' may require remote driver.
- Specify Lensed products to nearest 0.25". Specify Louvered and Tuneable White products in 6" increments for continuous light. Louver supplied in 6" increments, balance of the run will have recessed blank covers on ends.
- TW only available with RML/ROL for P2 and P3.
- Refer to specsheet for delivered lumen data for all product configurations.
- See power supply page for details.
- See Tiger Drylac color chart: [inter-lux.com/tiger](http://inter-lux.com/tiger)

index

technical  
information



# ProTools 60 Linear Direct/Indirect Wall / Mullion Mount

- 2.4" aperture, wall mount bi-directional luminaire
- Specialized mounting bracket to mount directly to 2.5" window mullion
- Standard and tailored run lengths, including corners
- Separately controllable up and down lighting with distribution options
- Choice of beam spreads to accommodate all applications
- Extreme brightness control and the elimination of disturbing glare
- Modularity of insert modules for ultimate design flexibility
- Consistent LED technology throughout the Whitegoods product range
- Flicker-free full range dimming with standard driver (Eldoled)
- Manufactured in the USA

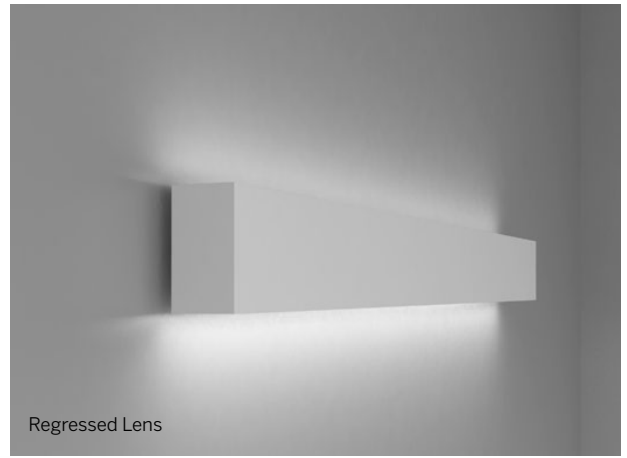

**Housing** Precision extruded aluminum for true dimensions and tolerances  
Toolless component assembly from below  
Mounts to horizontal 2" x 4" box or direct to the mounting surface  
Sure-lock mechanical connection system eliminates light leak  
Standard and tailored lengths including corner configurations  
Recessed snap-in cover for non-illuminated section  
Finishes: white, black, silver and custom

**Integration** Wall and mullion mounting brackets  
End wall mechanical and power connection option

**Distribution** 35, 50, 80, 105, 20x40 degree symmetrical downlight  
Asymmetric uplight standard

**LED** >90 CRI, 3-Step MacAdam, 2700-4000K static white  
3W - 15W per foot, 180 nominal lumens per watt average  
RA 91-94 (2700-4000K)  
L70 (TM21 Projected 85C) Static White / Tunable White = 72,000 hours  
Tunable white 2200-4000K, 80 nominal lumens per watt average

**Optic** RML - recessed micro-prismatic lens | diffusion with maximum efficiency  
ROL - regressed opal acrylic lens | evenly illuminated line of light  
RLW/RLB - recessed louver white (W) or black (B) | extreme cutoff  
REO - Recessed elliptical optic - high efficiency graze  
A/W - Snap-on acrylic uplight optic - assymetric distribution

**Reflector** White: high efficiency (standard with RLW)  
Black: no brightness (standard with RLB)  
Silver: low brightness  
All 15% gloss  
Custom finish available

**Driver** Compatible with quality constant current drivers

**Connectivity** POE  
Wireless

**Weight** 4lbs per foot

**Operating Temp** Suitable for operation in maximum ambient temperature of 35C (95F)

**Warranty** 5-year Limited (see complete company warranty information)

**Certifications** ETL and ETL-C for dry and damp location, CE

**Voltages** 120-277VAC

\*nominal lumens

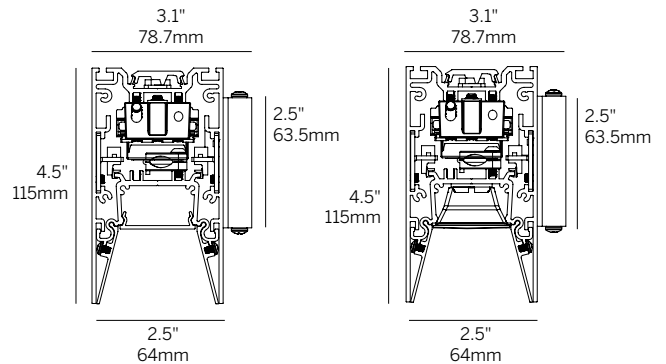
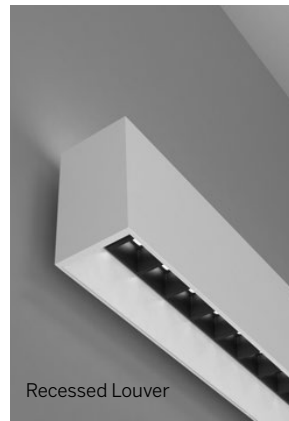

Recessed Micro-prismatic Lens (RML)

Recessed Louver (RLW, RLB)

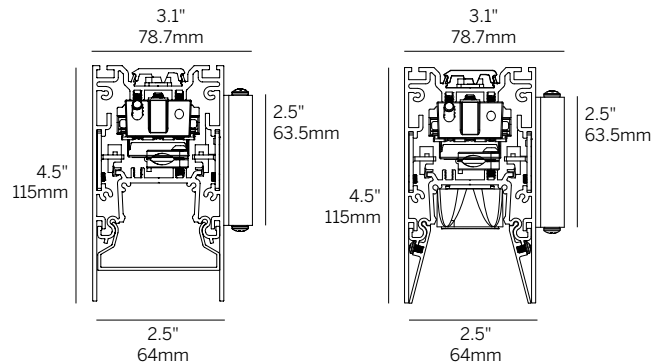

Regressed Opal Lens (ROL)

Recessed Elliptical Optic (REO)

# ProTools 60 Linear Direct/Indirect

## Wall / Mullion Mount

Model <sup>1</sup>	Fixation	Pattern	Length <sup>3</sup>	CRI/ CCT	Direct			Indirect		Driver <sup>7</sup>	Housing Finish <sup>8</sup>	Reflector Finish <sup>8</sup>	Options
					Optic <sup>4</sup>	Beam	Power <sup>6</sup>	Optic	Power <sup>6</sup>				
WG-60PTLDI	SW SWM	S PI <sup>2</sup> PO <sup>2</sup>	24 48 96 96 XX <sup>4</sup> 940 TW <sup>5</sup>	927 930 935 940 TW <sup>5</sup>	RML	80	P1	W	P1	E1	W (std)	W	DC EM EW
					ROL	105	P2 P3 P4	A	P2	L1 POE BT DALI TQ	B S F	B S F	
					RLW	35							
					RLB	50							
					REO	20x40							

### Model<sup>1</sup>

- WG-60PTLDI = ProTools 60 Linear Direct/Indirect

### Fixation

- SW = Surface Wall Mount
- SWM = Surface Wall Mullion Mount

### Pattern

- S = Straight run
- PI = Standard patterns 2, 3 or 4 sided with 90° inside corners on the same plane<sup>2</sup>
- PO = Standard patterns 2, 3 or 4 sided with 90° outside corners on the same plane<sup>2</sup>

### Length<sup>3</sup>

- 24 = 24"
- 48 = 48"
- 96 = 96"
- XX = Specify inches to the nearest 0.25"<sup>4</sup>

### CRI/CCT (90+ CRI)

- 927 = 2700K
- 930 = 3000K
- 935 = 3500K
- 940 = 4000K
- TW = Tuneable white 2200-4000K<sup>5</sup>

### Optic Direct<sup>4</sup>

- RML = Recessed micro-prismatic lens
- ROL = Regressed opal lens
- RLW = Recessed louver white (supplied with white reflectors standard)
- RLB = Recessed louver black (supplied with black reflectors only)<sup>4</sup>
- REO = Recessed elliptical optic

### Optic Indirect

- A = Asymmetric (standard)
- W = Wide (batwing)

### Beam

- 80 = 80° (RML)
- 105 = 105° (ROL)
- 35 = 35° (RLW, RLB)
- 50 = 50° (RLW, RLB)
- 20x40 = 20x40° (REO)

### Power Direct<sup>6</sup>

- P1 = 3W/ft
- P2 = 6W/ft
- P3 = 10W/ft
- P4 = 15W/ft

### Power Indirect Lens (W/A)<sup>6</sup>

- P1 = 3W/ft
- P2 = 6W/ft

### Driver<sup>7</sup>

- E1 = EdoLED 0.1% dimming, 0-10V (120-277V)
- L1 = Lutron 1% dimming, Ecosystem (120-277V)
- PoE = Power over Ethernet
- BT = Wireless CAS – Casambi (Must specify BT with E1 or DALI)
- DALI = EdoLED Dali DT8 0.1% (120-277V)
- TQ = T-Series for Lutron Quantum 0.1% (120-277V) (Tunable white ONLY)

### Housing Finish<sup>8</sup>

- W = White, 15% gloss, RAL 9003 / Tiger Drylac 049/11350 (standard)
- B = Black, 15% gloss, RAL 9005 / Tiger Drylac 044/90053
- S = Silver, 15% gloss, RAL 9006 / Tiger Drylac 049/90500
- F = Custom finished trim, specify RAL

### Reflector Finish<sup>8</sup>

- W = White, 15% gloss, RAL 9003 / Tiger Drylac 049/11350 (standard with RLW)
- B = Black, 15% gloss, RAL 9005 / Tiger Drylac 044/90053 (standard with RLB)
- S = Silver, 15% gloss, RAL 9006 / Tiger Drylac 049/90500
- F = Custom finished trim, specify RAL

### Options

- DC = Dual circuit
- EM = Emergency (remote)
- EW = End wall bracket

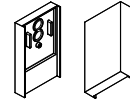

End Caps  
(2 included  
per run)

Whitegoods reserves the right to change any information without prior notice.

### Notes

- To specify Indirect only, leave direct (optic, beam, power) codes blank.
- See pattern spec sheet.
- Individual fixture lengths less than 2' may require remote driver.
- Specify Lensed products to nearest 0.25". Specify Louvered and Tuneable White products in 6" increments for continuous light. Louver supplied in 6" increments, balance of the run will have recessed blank covers on ends.
- TW only available with RML/ROL for P2 and P3.
- Refer to specsheet for delivered lumen data for all product configurations.
- See power supply page for details.
- See Tiger Drylac color chart: [inter-lux.com/tiger](http://inter-lux.com/tiger)

index

technical  
information



# 60 Linear Flush Lens

- Recessed
- Suspended
- Surface
- Wall

Application guide  
Product details

28-43  
80-91





**60 Linear** 2.4" aperture flush lens family offers straight runs or configurations for linear downlighting with high-angle illumination, lens options and Whitegoods attention to integration with surrounding materials.







///oi

# 60 Linear Recessed Flush Lens

- 2.4" aperture, integrated solution that is compatible with all ceiling types
- Standard and tailored run lengths, including corners, wall-to-wall and wall-to-ceiling configurations
- Flush lens for wide angle, even illumination
- Multiple control and connectivity options
- Consistent LED technology used throughout the Whitegoods product range
- Flexible design allows for installation from below with separate housing and gear tray for ease of installation and maintenance
- Flicker-free full range dimming with standard driver (Eldoled)
- Manufactured in the USA

<b>Housing</b>	Precision extruded aluminum for true dimensions and tolerances Snap-in flush lens for seamless integrated appearance Standard and tailored lengths including corners, wall-to-wall and wall-to-ceiling configurations Finishes: white, black, silver and custom
<b>Integration</b>	Fixation onto any surface such as gypsum, hard ceilings and all grid ceiling types
<b>Distribution</b>	High angle illumination linear downlight
<b>LED</b>	>90 CRI, 3-Step MacAdam, 2700-4000K static white 3W - 15W per foot, 180 nominal lumens per watt average, constant current Tunable white 2200-4000K, 80 nominal lumens per watt average RGBW, 50 nominal lumens per watt L70 (TM21 Projected 85C) Static White / Tunable White = 72,000 hours, RGBW = 50,000 hours
<b>Optic</b>	OD - Snap-in flush satin opal acrylic for even illumination DD - Snap-in 1" drop diffuser for wide distribution
<b>Driver</b>	Compatible with quality constant current drivers
<b>Connectivity</b>	POE Wireless
<b>Weight</b>	4lbs per foot
<b>Operating Temp</b>	Suitable for operation in maximum ambient temperature of 35C (95F)
<b>Warranty</b>	5-year Limited (see complete company warranty information)
<b>Certifications</b>	ETL and ETL-C for dry and damp location, CE, Chicago plenum
<b>Voltages</b>	120-277VAC

## Lenses/Accessories

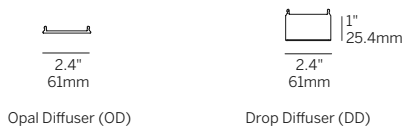

## Recessed Plaster Trim (60LDL-RPT)

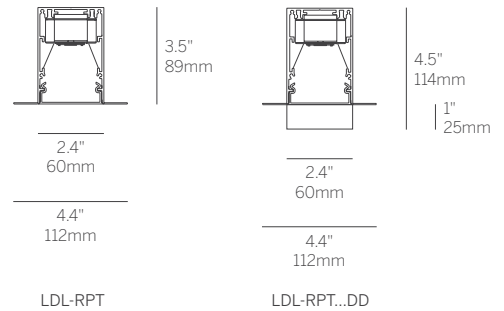
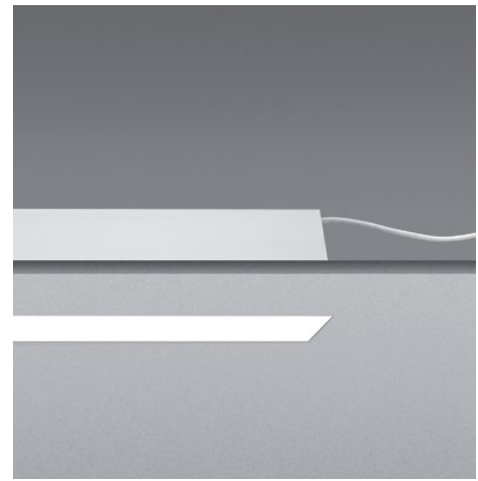

## Recessed Bezel Trim / Grid Trim (60LDL-RBT/RGT)

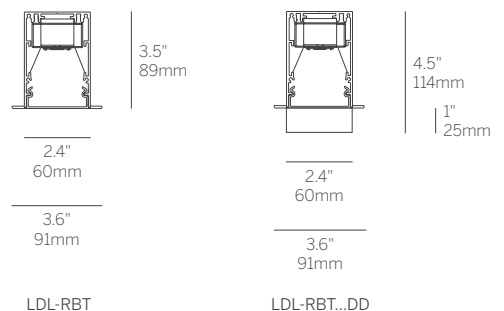

# 60 Linear Recessed Flush Lens

Model	Fixation	Pattern	Length	Power <sup>2</sup>	CRI/CCT <sup>3</sup>	Driver <sup>5</sup>	Lens	Finish <sup>7</sup>	Options
WG-60LDL	RPT RBT RGT9 RGT15 RGTS	S P <sup>1</sup> PPI <sup>1</sup> PPO <sup>1</sup> PZ <sup>1</sup>	A A x B A x B x C A x B x A x B	P1 P2 P3 P4 M	927 930 935 940 TW <sup>4</sup> RGBW	E1 L1 POE BT DALI TQ DMX	OD (std) DD <sup>6</sup>	W (std) B S F	CP EM NYC

## Model

- WG-60LDL = 60 Linear Recessed Downlight

## Fixation

- RPT = Recessed plaster trim
- RBT = Recessed bezel trim for hard ceiling
- RGT9 = Recessed trim for 9/16" grid
- RGT15 = Recessed trim for 15/16" grid
- RGTS = Recessed grid trim slot

## Pattern

- S = Straight run
- P = Standard patterns 2, 3 or 4 sided with 90° corners on the same plane<sup>1</sup>
- PPI = Wall to ceiling / wall to wall, 90° inside corner<sup>1</sup>
- PPO = Wall to ceiling / wall to wall, 90° outside corner<sup>1</sup>
- PZ = Non-standard patterns and/or corners other than 90° on multiple planes, consult factory<sup>1</sup>

## Length

- A, B, C = specify inches to the nearest 0.25" (i.e. 72.25"). For patterns specify each length (i.e. 2 sided: A x B = 72.25" x 48"; 3 sided: A x B x C; 4 sided: A x B x A x B).

## Power<sup>2</sup>

- P1 = 3W/ft
- P2 = 6W/ft
- P3 = 10W/ft
- P4 = 15W/ft
- M = 7.6W/ft (RGBW Only)

## CRI/CCT (90+ CRI)<sup>3</sup>

- 927 = 2700K
- 930 = 3000K
- 935 = 3500K
- 940 = 4000K
- TW = Tuneable white 2200-4000K<sup>4</sup>
- RGBW = 3000K White

## Driver (Integral)<sup>5</sup>

- E1 = EldoLED 0.1% dimming, 0-10V (120-277V)
- L1 = Lutron 1% dimming, Ecosystem (120-277V)
- PoE = Power over Ethernet
- BT = Wireless CAS – Casambi (Must specify BT with E1 or DALI)
- DALI = EldoLED Dali DT8 0.1% (120-277V)
- TQ = T-Series for Lutron Quantum 0.1% (120-277V) (Tunable white ONLY)
- DMX = Osram+EldoLED, 24V, DMX Dimming (RGBW ONLY)

## Lens

- OD = Satin opal diffuser (standard diffuser)
- DD = Drop diffuser<sup>6</sup>

## Finish<sup>7</sup>

- W = White, 15% gloss, RAL 9010 / Tiger Drylac 009/10120 (standard)
- B = Black, 15% gloss, RAL 9005 / Tiger Drylac 044/90053
- S = Silver, 15% gloss, RAL 9006 / Tiger Drylac 049/90500
- F = Custom finished trim, specify RAL

## Options

- CP = Chicago plenum
- EM = Emergency LED driver (remote only)
- NYC = 6' whip per run

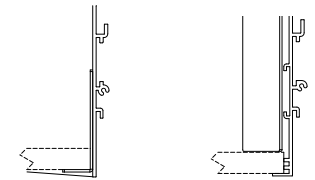

Plaster trim (RPT)

Recessed trim (RBT)

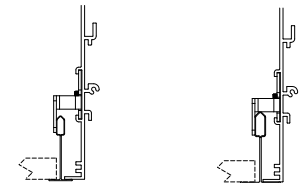

9/16" grid (RGT9)

15/16" grid (RGT15)

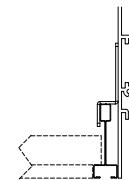

Slot grid (RGTS)

Whitegoods reserves the right to change any information without prior notice.

## Notes

- See pattern spec sheet.
- Wattage shown does not include power supplies/drivers.
- See spec page for delivered lumens.
- TW only available with P2 and P3.
- See power supply page for details.
- Butt seam (lens) when in continuous run, straight runs only.
- See Tiger Drylac color chart: [inter-lux.com/tiger](http://inter-lux.com/tiger)

index

technical  
information



# 60 Linear Suspended Flush Lens

- 2.4" aperture, integrated solution that is compatible with all ceiling types
- Standard and tailored run lengths, including corners, in suspended configurations
- Flush lens for wide angle, even illumination
- Multiple control and connectivity options
- Consistent LED technology used throughout the Whitegoods product range
- Flexible design allows for installation from below with separate housing and gear tray for ease of installation and maintenance
- Flicker-free full range dimming with standard driver (Eldoled)
- Manufactured in the USA

**Housing** Precision extruded aluminum for true dimensions and tolerances  
 Snap-in flush lens for seamless integrated appearance  
 Standard and tailored lengths including corners, in suspended configurations  
 Finishes: white, black, silver and custom

**Integration** Ceiling canopy mounts to any ceiling surface

**Distribution** High angle illumination linear downlight

**LED** >90 CRI, 3-Step MacAdam, 2700-4000K static white  
 3W - 15W per foot, 180 nominal lumens per watt average, constant current  
 Tuneable white 2200-4000K, 80 nominal lumens per watt average  
 RGBW, 50 nominal lumens per watt  
 L70 (TM21 Projected 85C) Static White / Tunable White = 72,000 hours,  
 RGBW = 50,000 hours

**Optic** OD - Snap-in flush satin opal acrylic for even illumination  
 DD - Snap-in 1" drop diffuser for wide distribution

**Driver** Compatible with quality constant current drivers

**Connectivity** POE  
 Wireless

**Weight** 4lbs per foot

**Operating Temp** Suitable for operation in maximum ambient temperature of 35C (95F)

**Warranty** 5-year Limited (see complete company warranty information)

**Certifications** ETL and ETL-C for dry and damp location, CE, Chicago plenum

**Voltages** 120-277VAC

Suspended (60LDL)

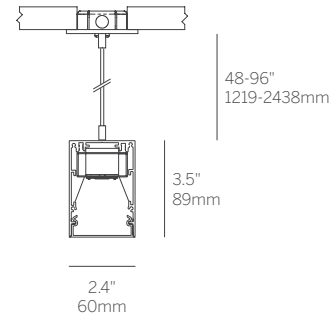
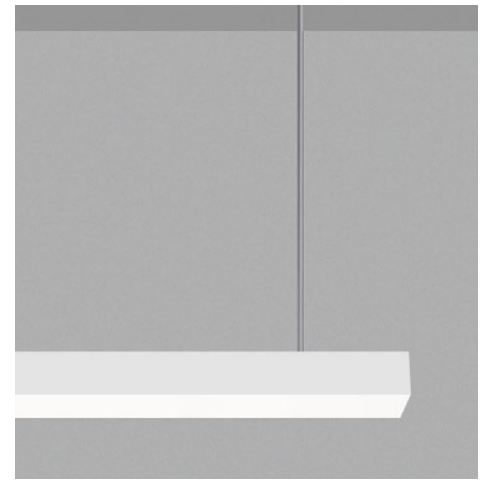

Suspended / Drop Diffuser (60LDL...DD)

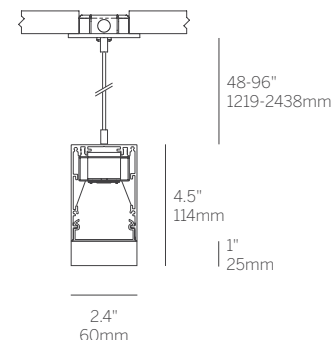

**Lenses/Accessories**

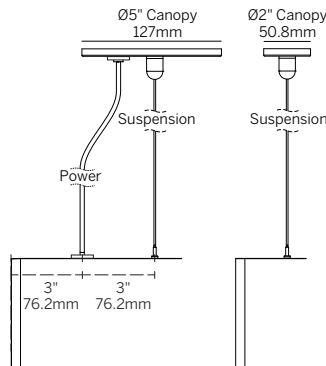
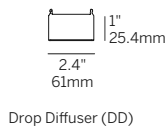
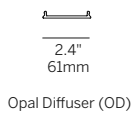

# 60 Linear Suspended Flush Lens

Model	Fixation	Pattern	Length	Power <sup>2</sup>	CRI/ CCT <sup>3</sup>	Driver <sup>5</sup>	Lens	Finish <sup>7</sup>	Options
WG-60LDL	S48 S96 SXX	S P <sup>1</sup> PZ <sup>1</sup>	A A x B A x B x C A x B x A x B	P1 P2 P3 P4 M	927 930 935 940 TW <sup>4</sup> RGBW	E1 L1 POE BT DALI TQ DMX	OD (std) DD <sup>6</sup>	W (std) B S F	EM

## Model

- WG-60LDL = 60 Linear Suspended Downlight

## Fixation

- S48 = 48" suspension cable, field-cutttable (standard)
- S96 = 96" suspension cable, field-cutttable
- SXX = Specify suspension cable length

## Pattern

- S = Straight run
- P = Standard patterns 2, 3 or 4 sided with 90° corners on the same plane<sup>1</sup>
- PZ = Non-standard patterns and/or corners other than 90°, consult factory<sup>1</sup>

## Length

- A, B, C = specify inches to the nearest 0.25" (i.e. 72.25"). For patterns specify each length (i.e. 2 sided: A x B = 72.25" x 48"; 3 sided: A x B x C; 4 sided: A x B x A x B).

## Power<sup>2</sup>

- P1 = 3W/ft
- P2 = 6W/ft
- P3 = 10W/ft
- P4 = 15W/ft
- M = 7.6W/ft (RGBW Only)

## CRI/CCT (90+ CRI)<sup>3</sup>

- 927 = 2700K
- 930 = 3000K
- 935 = 3500K
- 940 = 4000K
- TW = Tuneable white 2200-4000K<sup>4</sup>
- RGBW = 3000K White

## Driver (Integral)<sup>5</sup>

- E1 = EldoLED 0.1% dimming, 0-10V (120-277V)
- L1 = Lutron 1% dimming, Ecosystem (120-277V)
- PoE = Power over Ethernet
- BT = Wireless CAS – Casambi (Must specify BT with E1 or DALI)
- DALI = EldoLED Dali DT8 0.1% (120-277V)
- TQ = T-Series for Lutron Quantum 0.1% (120-277V) (Tunable white ONLY)
- DMX = Osram+EldoLED, 24V, DMX Dimming (RGBW ONLY)

## Lens

- OD = Satin opal diffuser (standard diffuse)
- DD = Drop diffuser<sup>6</sup>

## Finish<sup>7</sup>

- W = White, 15% gloss, RAL 9010 / Tiger Drylac 009/10120 (standard)
- B = Black, 15% gloss, RAL 9005 / Tiger Drylac 044/90053
- S = Silver, 15% gloss, RAL 9006 / Tiger Drylac 049/90500
- F = Custom finished trim, specify RAL

## Options

- EM = Emergency LED driver (remote only)

Whitegoods reserves the right to change any information without prior notice.

## Notes

- 1 See pattern spec sheet.
- 2 Wattage shown does not include power supplies/drivers.
- 3 See spec page for delivered lumens.
- 4 TW only available with P2 and P3.
- 5 See power supply page for details.
- 6 Butt seam (lens) when in continuous run, straight runs only.
- 7 See Tiger Drylac color chart: [inter-lux.com/tiger](http://inter-lux.com/tiger)

index

technical  
information



# 60 Linear Suspended Direct / Indirect Flush Lens

- 2.4" aperture, integrated solution that is compatible with all ceiling types
- Standard and tailored run lengths, including corners, in suspended configurations
- Flush lens for wide angle, even illumination
- Multiple control and connectivity options
- Consistent LED technology used throughout the Whitegoods product range
- Flexible design allows for installation from below with separate housing and gear tray for ease of installation and maintenance
- Flicker-free full range dimming with standard driver (Eldoled)
- Manufactured in the USA

**Housing** Precision extruded aluminum for true dimensions and tolerances  
 Snap-in flush lens for seamless integrated appearance  
 Standard and tailored lengths including corners, in suspended configurations  
 Finishes: white, black, silver and custom

**Integration** Ceiling canopy mounts to any ceiling surface

**Distribution** High angle illumination linear downlight

**LED** >90 CRI, 3-Step MacAdam, 2700-4000K static white  
 3W - 15W per foot, 180 nominal lumens per watt average, constant current  
 Tuneable white 2200-4000K, 80 nominal lumens per watt average  
 RGBW, 50 nominal lumens per watt  
 L70 (TM21 Projected 85C) Static White / Tunable White = 72,000 hours,  
 RGBW = 50,000 hours

**Optic** OD - Snap-in flush satin opal acrylic for even illumination  
 SD - Satin Clear Diffuser provides high efficiency soft edge beam, recommended for uplight  
 DD - Snap-in 1" drop diffuser for wide distribution

**Driver** Compatible with quality constant current drivers

**Connectivity** POE  
 Wireless

**Weight** 4lbs per foot

**Operating Temp** Suitable for operation in maximum ambient temperature of 35C (95F)

**Warranty** 5-year Limited (see complete company warranty information)

**Certifications** ETL and ETL-C for dry and damp location, CE, Chicago plenum

**Voltages** 120-277VAC

## Lenses/Accessories

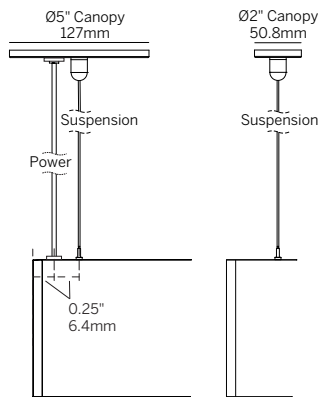
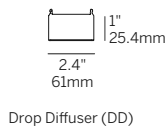
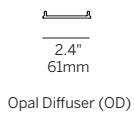

Suspended (60LDI)

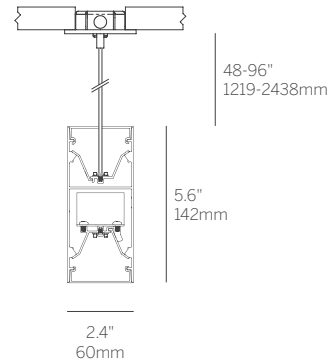

Suspended / Drop Diffuser (60LDI...DD)

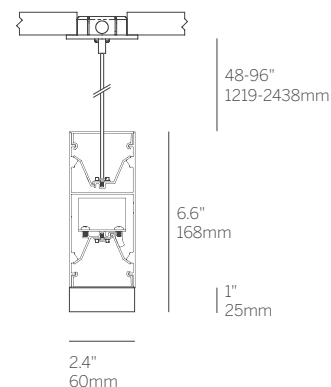
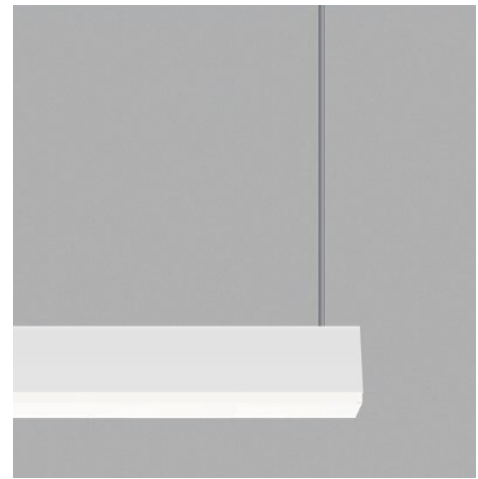



# 60 Linear Suspended Direct / Indirect Flush Lens

Model <sup>1</sup>	Fixation	Pattern	Length	Direct				Indirect				Finish <sup>8</sup>	Options
				Power <sup>3</sup>	CRI <sup>4</sup>	Driver <sup>6</sup>	Lens	Power <sup>3</sup>	CRI <sup>4</sup>	Driver <sup>6</sup>	Lens		
WG-60LDI	S48 S96 SXX	S P <sup>2</sup> PZ <sup>2</sup>	A	P1	927	E1	OD	P1	927	E1	SD	W (std) B S F	DC EM
			A x B	P2	930	L1	(std)	P2	930	L1	(std)		
			A x B x C	P3	935	POE	DD <sup>7</sup>	P3	935	POE	OD		
			A x B x A x B	P4	940	BT		P4	940	BT			
				M	TW <sup>5</sup> RGBW	DALI TQ DMX		M	TW <sup>5</sup> RGBW	DALI TQ DMX			

## Model<sup>1</sup>

- WG-60LDI = 60 Linear Suspended Direct/Indirect

## Fixation

- S48 = 48" suspension cable, field-cuttable (standard)
- S96 = 96" suspension cable, field-cuttable
- SXX = Specify suspension cable length

## Pattern

- S = Straight run
- P = Standard patterns 2, 3 or 4 sided with 90° corners on the same plane<sup>2</sup>
- PZ = Non-standard patterns and/or corners other than 90° on multiple planes, consult factory<sup>2</sup>

## Length

- A, B, C = specify inches to the nearest 0.25" (i.e. 72.25"). For patterns specify each length (i.e. 2 sided: A x B = 72.25" x 48"; 3 sided: A x B x C; 4 sided: A x B x A x B).

## Power<sup>3</sup>

- P1 = 3W/ft
- P2 = 6W/ft
- P3 = 10W/ft
- P4 = 15W/ft
- M = 7.6W/ft (RGBW Only)

## CRI/CCT (90+ CRI)<sup>4</sup>

- 927 = 2700K
- 930 = 3000K
- 935 = 3500K
- 940 = 4000K
- TW = Tuneable white 2200-4000K<sup>5</sup>
- RGBW = 3000K White

## Driver (Integral)<sup>6</sup>

- E1 = EldoLED 0.1% dimming, 0-10V (120-277V)
- L1 = Lutron 1% dimming, Ecosystem (120-277V)
- PoE = Power over Ethernet
- BT = Wireless CAS – Casambi (Must specify BT with E1 or DALI)
- DALI = EldoLED Dali DT8 0.1% (120-277V)
- TQ = T-Series for Lutron Quantum 0.1% (120-277V) (Tunable white ONLY)
- DMX = Osram+EldoLED, 24V, DMX Dimming (RGBW ONLY)

## Lens

- OD = Satin opal diffuser (standard diffuser)
- SD = Satin clear diffuser (high efficiency diffuser) (recommended for uplight)
- DD = Drop diffuser (Direct ONLY)<sup>7</sup>

## Finish<sup>8</sup>

- W = White, 15% gloss, RAL 9010 / Tiger Drylac 009/10120 (standard)
- B = Black, 15% gloss, RAL 9005 / Tiger Drylac 044/90053
- S = Silver, 15% gloss, RAL 9006 / Tiger Drylac 049/90500
- F = Custom finished trim, specify RAL

## Options

- DC = Dual circuit
- EM = Emergency LED driver (remote only)

Whitegoods reserves the right to change any information without prior notice.

## Notes

- To specify Direct or Indirect only, leave Power, CRI, Driver and Lens blank for direction without light.
- See pattern spec sheet.
- Wattage shown does not include power supplies/drivers. Maximum combined wattage if specifying Direct Power + Indirect Power is 21 W/ft (i.e. P4 Direct [1 W/ft] + P2 Indirect [6 W/ft]).
- See spec page for delivered lumens.
- TW only available with P2 and P3.
- See power supply page for details.
- Butt seam (lens) when in continuous run, straight runs only.
- See Tiger Drylac color chart: [inter-lux.com/tiger](http://inter-lux.com/tiger)

index

technical  
information



# 60 Linear Surface Flush Lens

- 2.4" aperture, integrated solution that is compatible with all ceiling types
- Standard and tailored run lengths, including corners, wall-to-wall and wall-to-ceiling configurations
- Flush lens for wide angle, even illumination
- Multiple control and connectivity options
- Consistent LED technology used throughout the Whitegoods product range
- Flexible design allows for installation from below with separate housing and gear tray for ease of installation and maintenance
- Flicker-free full range dimming with standard driver (Eldoled)
- Manufactured in the USA

**Housing** Precision extruded aluminum for true dimensions and tolerances  
 Snap-in flush lens for seamless integrated appearance  
 Standard and tailored lengths including corners, wall-to-wall and wall-to-ceiling configurations  
 Finishes: white, black, silver and custom

**Integration** Fixation onto any surface such as gypsum, wood and all grid ceiling types

**Distribution** High angle illumination linear downlight

**LED** >90 CRI, 3-Step MacAdam, 2700-4000K static white  
 3W - 15W per foot, 180 nominal lumens per watt average, constant current  
 Tuneable white 2200-4000K, 80 nominal lumens per watt average  
 RGBW, 50 nominal lumens per watt  
 L70 (TM21 Projected 85C) Static White / Tunable White = 72,000 hours,  
 RGBW = 50,000 hours

**Optic** OD - Snap-in flush satin opal acrylic for even illumination  
 DD - Snap-in 1" drop diffuser for wide distribution

**Driver** Compatible with quality constant current drivers

**Connectivity** POE  
 Wireless

**Weight** 4lbs per foot

**Operating Temp** Suitable for operation in maximum ambient temperature of 35C (95F)

**Warranty** 5-year Limited (see complete company warranty information)

**Certifications** ETL and ETL-C for dry and damp location, CE, Chicago plenum

**Voltages** 120-277VAC

Surface (60LDL-SM)

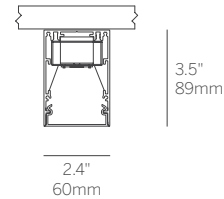

Surface / Drop Diffuser (60LDL-SM...DD)

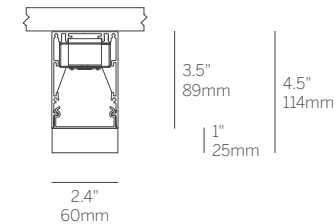
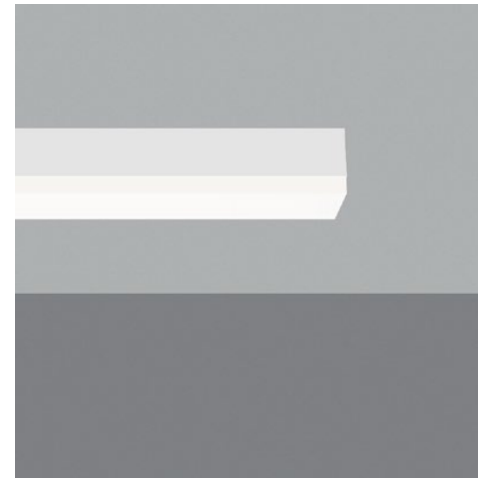

## Lenses/Accessories



Opal Diffuser (OD)

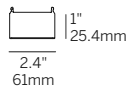

Drop Diffuser (DD)

# 60 Linear Surface Flush Lens

Model	Fixation	Pattern	Length	Power <sup>2</sup>	CRI/ CCT <sup>3</sup>	Driver <sup>5</sup>	Lens	Finish <sup>7</sup>	Options
WG-60LDL	SM	S P1 PPI <sup>1</sup> PPO <sup>1</sup> PZ <sup>1</sup>	A A x B A x B x C A x B x A x B	P1 P2 P3 P4 M	927 930 935 940 TW <sup>4</sup> RGBW	E1 L1 POE BT DALI TQ DMX	OD (std) DD <sup>6</sup>	W (std) B S F	EM

## Model

- WG-60LDL = 60 Linear Surface Downlight

## Fixation

- SM = Surface Mount

## Pattern

- S = Straight run
- P = Standard patterns 2, 3 or 4 sided with 90° corners on the same plane<sup>1</sup>
- PPI = Wall to ceiling / wall to wall, 90° inside corner<sup>1</sup>
- PPO = Wall to ceiling / wall to wall, 90° outside corner<sup>1</sup>
- PZ = Non-standard patterns and/or corners other than 90° on multiple planes, consult factory<sup>1</sup>

## Length

- A, B, C = specify inches to the nearest 0.25" (i.e. 72.25"). For patterns specify each length (i.e. 2 sided: A x B = 72.25" x 48"; 3 sided: A x B x C; 4 sided: A x B x A x B).

## Power<sup>2</sup>

- P1 = 3W/ft
- P2 = 6W/ft
- P3 = 10W/ft
- P4 = 15W/ft
- M = 7.6W/ft (RGBW Only)

## CRI/CCT (90+ CRI)<sup>3</sup>

- 927 = 2700K
- 930 = 3000K
- 935 = 3500K
- 940 = 4000K
- TW = Tuneable white 2200-4000K<sup>4</sup>
- RGBW = 3000K White

## Driver (Integral)<sup>5</sup>

- E1 = EldoLED 0.1% dimming, 0-10V (120-277V)
- L1 = Lutron 1% dimming, Ecosystem (120-277V)
- PoE = Power over Ethernet
- BT = Wireless CAS – Casambi (Must specify BT with E1 or DALI)
- DALI = EldoLED Dali DT8 0.1% (120-277V)
- TQ = T-Series for Lutron Quantum 0.1% (120-277V) (Tunable white ONLY)
- DMX = Osram+EldoLED, 24V, DMX Dimming (RGBW ONLY)

## Lens

- OD = Satin opal diffuser (standard diffuse)
- DD = Drop diffuser<sup>6</sup>

## Finish<sup>7</sup>

- W = White, 15% gloss, RAL 9010 / Tiger Drylac 009/10120 (standard)
- B = Black, 15% gloss, RAL 9005 / Tiger Drylac 044/90053
- S = Silver, 15% gloss, RAL 9006 / Tiger Drylac 049/90500
- F = Custom finished trim, specify RAL

## Options

- EM = Emergency LED driver (remote only)

Whitegoods reserves the right to change any information without prior notice.

## Notes

- See pattern spec sheet.
- Wattage shown does not include power supplies/drivers.
- See spec page for delivered lumens.
- TW only available with P2 and P3.
- See power supply page for details.
- Butt seam (lens) when in continuous run, straight runs only.
- See Tiger Drylac color chart: [inter-lux.com/tiger](http://inter-lux.com/tiger)

index

technical  
information



# 60 Linear Wall Direct or Indirect Flush Lens

- 2.4" aperture, surface mounted fixture
- Standard and tailored run lengths, including corners, wall-to-wall configurations
- Flush lens for wide angle, even illumination
- Multiple control and connectivity options
- Consistent LED technology used throughout the Whitegoods product range
- Flexible design allows for installation from below with separate housing and gear tray for ease of installation and maintenance
- Flicker-free full range dimming with standard driver (Eldoled)
- Manufactured in the USA



**Housing** Precision extruded aluminum for true dimensions and tolerances  
 Snap-in flush lens for seamless integrated appearance  
 Standard and tailored lengths including corners, wall-to-wall configurations  
 Finishes: white, black, silver and custom

**Integration** Surface mounting bracket mounts to any wall or mullion

**Distribution** High angle illumination linear downlight

**LED** >90 CRI, 3-Step MacAdam, 2700-4000K static white  
 3W - 15W per foot, 180 nominal lumens per watt average, constant current  
 Tuneable white 2200-4000K, 80 nominal lumens per watt average  
 RGBW, 50 nominal lumens per watt  
 L70 (TM21 Projected 85C) Static White / Tunable White = 72,000 hours,  
 RGBW = 50,000 hours

**Optic** OD - Snap-in flush satin opal acrylic for even illumination  
 SD - Satin Clear Diffuser provides high efficiency soft edge beam, recommended for uplight

**Driver** Compatible with quality constant current drivers

**Connectivity** POE  
 Wireless

**Weight** 4lbs per foot

**Operating Temp** Suitable for operation in maximum ambient temperature of 35C (95F)

**Warranty** 5-year Limited (see complete company warranty information)

**Certifications** ETL and ETL-C for dry and damp location, CE, Chicago plenum

**Voltages** 120-277VAC

Surface Wall Mount (60LD/60LI-SW)

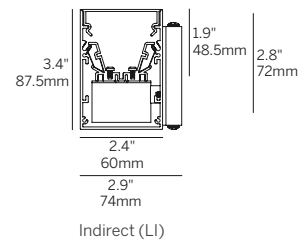
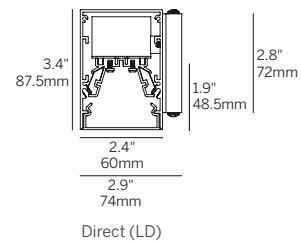

Surface Wall Mullion Mount (60LD/60LI-SWM)

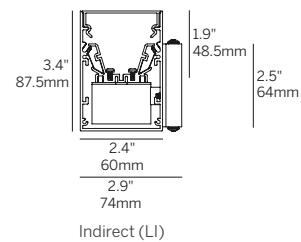
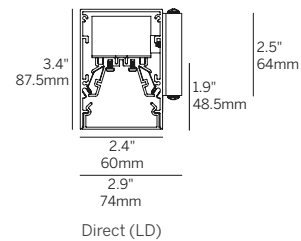

## Lenses/Accessories



Opal Diffuser (OD)  
 Satin Diffuser (SD)

# 60 Linear Wall Direct or Indirect Flush Lens

Model	Fixation	Pattern	Length	Power <sup>2</sup>	CRI/ CCT <sup>3</sup>	Driver <sup>5</sup>	Lens	Finish <sup>6</sup>	Options
WG-60LD direct WG-60LI indirect	SW SWM	S PI <sup>1</sup> PO <sup>1</sup>	A A x B A x B x C A x B x A x B	P1 P2 P3 P4 M	927 930 935 940 TW <sup>4</sup> RGBW	E1 L1 POE BT DALI TQ DMX	OD (std) SD	W (std) B S F	EM

## Model

- WG-60LD = 60 Linear Surface Wall Direct
- WG-60LI = 60 Linear Surface Wall Indirect

## Fixation

- SW = Surface Wall Mount
- SWM = Surface Wall Mullion Mount

## Pattern

- S = Straight run
- PI = Standard patterns 2, 3 or 4 sided with 90° inside corners on the same plane<sup>1</sup>
- PO = Standard patterns 2, 3 or 4 sided with 90° outside corners on the same plane<sup>1</sup>

## Length

- A, B, C = specify inches to the nearest 0.25" (i.e. 72.25"). For patterns specify each length (i.e. 2 sided: A x B = 72.25" x 48"; 3 sided: A x B x C; 4 sided: A x B x A x B).

## Power<sup>2</sup>

- P1 = 3W/ft
- P2 = 6W/ft
- P3 = 10W/ft
- P4 = 15W/ft
- M = 7.6W/ft (RGBW Only)

## CRI/CCT (90+ CRI)<sup>3</sup>

- 927 = 2700K
- 930 = 3000K
- 935 = 3500K
- 940 = 4000K
- TW = Tuneable white 2200-4000K<sup>4</sup>
- RGBW = 3000K White

## Driver (Integral)<sup>5</sup>

- E1 = EdoLED 0.1% dimming, 0-10V (120-277V)
- L1 = Lutron 1% dimming, Ecosystem (120-277V)
- PoE = Power over Ethernet
- BT = Wireless CAS – Casambi (Must specify BT with E1 or DALI)
- DALI = EdoLED Dali DT8 0.1% (120-277V)
- TQ = T-Series for Lutron Quantum 0.1% (120-277V) (Tunable white ONLY)
- DMX = Osram+EdoLED, 24V, DMX Dimming (RGBW ONLY)

## Lens

- OD = Satin opal diffuser (standard diffuser)
- SD = Satin clear diffuser, high efficiency (recommended for uplight)

## Finish<sup>6</sup>

- W = White, 15% gloss, RAL 9010 / Tiger Drylac 009/10120 (standard)
- B = Black, 15% gloss, RAL 9005 / Tiger Drylac 044/90053
- S = Silver, 15% gloss, RAL 9006 / Tiger Drylac 049/90500
- F = Custom finished trim, specify RAL

## Options

- EM = Emergency LED driver (remote only)

Whitegoods reserves the right to change any information without prior notice.

## Notes

- 1 See pattern spec sheet.
- 2 Wattage shown does not include power supplies/drivers.
- 3 See spec page for delivered lumens.
- 4 TW only available with P2 and P3.
- 5 See power supply page for details.
- 6 See Tiger Drylac color chart: [inter-lux.com/tiger](http://inter-lux.com/tiger)

index

technical  
information



# 60 Linear Wall Direct / Indirect Flush Lens

- 2.4" aperture, surface mounted fixture
- Standard and tailored run lengths, including corners, wall-to-wall configurations
- Flush lens for wide angle, even illumination
- Multiple control and connectivity options
- Consistent LED technology used throughout the Whitegoods product range
- Flexible design allows for installation from below with separate housing and gear tray for ease of installation and maintenance
- Flicker-free full range dimming with standard driver (Eldoled)
- Manufactured in the USA

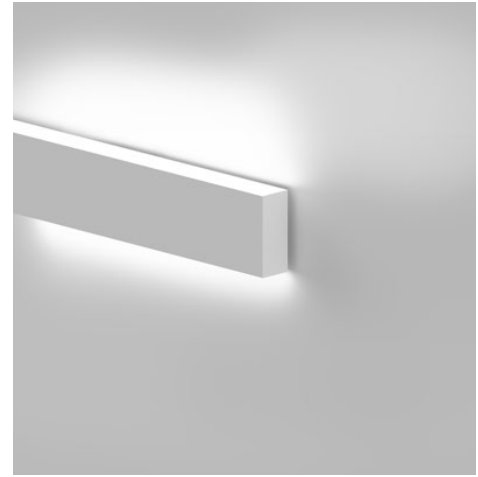

**Housing** Precision extruded aluminum for true dimensions and tolerances  
 Snap-in flush lens for seamless integrated appearance  
 Standard and tailored lengths including corners, wall-to-wall configurations  
 Finishes: white, black, silver and custom

**Integration** Surface mounting bracket mounts to any wall or mullion

**Distribution** High angle illumination linear downlight

**LED** >90 CRI, 3-Step MacAdam, 2700-4000K static white  
 3W - 15W per foot, 180 nominal lumens per watt average, constant current  
 Tuneable white 2200-4000K, 80 nominal lumens per watt average  
 RGBW, 50 nominal lumens per watt  
 L70 (TM21 Projected 85C) Static White / Tunable White = 72,000 hours,  
 RGBW = 50,000 hours

**Optic** OD - Snap-in flush satin opal acrylic for even illumination  
 SD - Satin Clear Diffuser provides high efficiency soft edge beam, recommended for uplight

**Driver** Compatible with quality constant current drivers

**Connectivity** POE  
 Wireless

**Weight** 4lbs per foot

**Operating Temp** Suitable for operation in maximum ambient temperature of 35C (95F)

**Warranty** 5-year Limited (see complete company warranty information)

**Certifications** ETL and ETL-C for dry and damp location, CE, Chicago plenum

**Voltages** 120-277VAC

Surface Wall Mount (60LDI-SW)

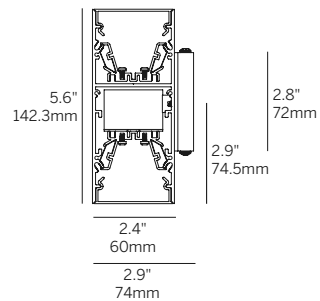

Surface Wall Mullion Mount (60LDI-SWM)

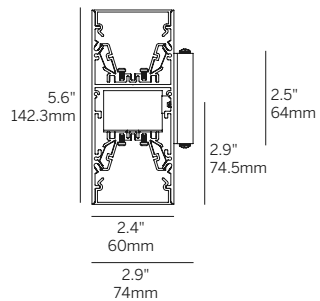

## Lenses/Accessories



Opal Diffuser (OD)  
 Satin Diffuser (SD)

# 60 Linear Wall Direct / Indirect Flush Lens

Model <sup>1</sup>	Fixation	Pattern	Length	Direct				Indirect				Finish <sup>7</sup>	Options
				Power <sup>3</sup>	CRI <sup>4</sup>	Driver <sup>6</sup>	Lens	Power <sup>3</sup>	CRI <sup>4</sup>	Driver <sup>6</sup>	Lens		
WG-60LDI	SW SWM	S PI <sup>2</sup> PO <sup>2</sup>	A	P1	927	E1	OD	P1	927	E1	SD	W (std) B S F	DC EM
			A x B	P2	930	L1	(std)	P2	930	L1	(std)		
			A x B x C	P3	935	POE		P3	935	POE	OD		
			A x B x A x B	P4	940	BT		P4	940	BT			
				M	TW <sup>5</sup> RGBW	DALI TQ DMX		M	TW <sup>5</sup> RGBW	DALI TQ DMX			

## Model<sup>1</sup>

- WG-60LDI = 60 Linear Surface Wall Direct/Indirect

## Fixation

- SW = Surface Wall Mount
- SWM = Surface Wall Mullion Mount

## Pattern

- S = Straight run
- PI = Standard patterns 2, 3 or 4 sided with 90° inside corners on the same plane<sup>2</sup>
- PO = Standard patterns 2, 3 or 4 sided with 90° outside corners on the same plane<sup>2</sup>

## Length

- A, B, C = specify inches to the nearest 0.25" (i.e. 72.25"). For patterns specify each length (i.e. 2 sided: A x B = 72.25" x 48"; 3 sided: A x B x C; 4 sided: A x B x A x B).

## Power<sup>3</sup>

- P1 = 3W/ft
- P2 = 6W/ft
- P3 = 10W/ft
- P4 = 15W/ft
- M = 7.6W/ft (RGBW Only)

## CRI/CCT (90+ CRI)<sup>4</sup>

- 927 = 2700K
- 930 = 3000K
- 935 = 3500K
- 940 = 4000K
- TW = Tuneable white 2200-4000K<sup>5</sup>
- RGBW = 3000K White

## Driver (Integral)<sup>6</sup>

- E1 = EldoLED 0.1% dimming, 0-10V (120-277V)
- L1 = Lutron 1% dimming, Ecosystem (120-277V)
- PoE = Power over Ethernet
- BT = Wireless CAS – Casambi (Must specify BT with E1 or DALI)
- DALI = EldoLED Dali DT8 0.1% (120-277V)
- TQ = T-Series for Lutron Quantum 0.1% (120-277V) (Tunable white ONLY)
- DMX = Osram+EldoLED, 24V, DMX Dimming (RGBW ONLY)

## Lens

- OD = Satin opal diffuser (standard diffuse)
- SD = Satin clear diffuser (high efficiency diffuse) (recommended for uplight)

## Finish<sup>7</sup>

- W = White, 15% gloss, RAL 9010 / Tiger Drylac 009/10120 (standard)
- B = Black, 15% gloss, RAL 9005 / Tiger Drylac 044/90053
- S = Silver, 15% gloss, RAL 9006 / Tiger Drylac 049/90500
- F = Custom finished trim, specify RAL

## Options

- DC = Dual circuit
- EM = Emergency LED driver (remote only)

Whitegoods reserves the right to change any information without prior notice.

## Notes

- To specify Direct or Indirect only, leave Power, CRI, Driver and Lens blank for direction without light.
- See pattern spec sheet.
- Wattage shown does not include power supplies/drivers. Wattage shown does not include power supplies/drivers. Maximum combined wattage if specifying Direct Power + Indirect Power is 21 W/ft (i.e. P4 Direct [1 W/ft] + P2 Indirect [6 W/ft]).
- See spec page for delivered lumens.
- TW only available with P2 and P3.
- See power supply page for details.
- See Tiger Drylac color chart: [inter-lux.com/tiger](http://inter-lux.com/tiger)

index

technical  
information



# 100 Linear Flush Lens

- Recessed
- Surface
- Suspended

Application guide  
Product details

28-43  
96-101





**100 Linear** 4" aperture flush lens family offers straight runs or configurations for linear downlighting with high-angle illumination, lens options and Whitegoods attention to integration with surrounding materials.





GOLDFINCH  
STUDY  
L110

ΦΔΕ



# 100 Linear Recessed Flush Lens

- 4" aperture, integrated solution that is compatible with all ceiling types
- Standard and tailored run lengths, including corners, wall-to-wall and wall-to-ceiling configurations
- Flush lens for wide angle, even illumination
- Multiple control and connectivity options
- Consistent LED technology used throughout the Whitegoods product range
- Flexible design allows for installation from below with separate housing and gear tray for ease of installation and maintenance
- Flicker-free full range dimming with standard driver (Eldoled)
- Manufactured in the USA

<b>Housing</b>	Precision extruded aluminum for true dimensions and tolerances Snap-in flush lens for seamless integrated appearance Standard and tailored lengths including corners, wall-to-wall and wall-to-ceiling configurations Finishes: white, black, silver and custom
<b>Integration</b>	Fixation onto any surface such as gypsum, hard ceilings and all grid ceiling types
<b>Distribution</b>	High angle illumination linear downlight
<b>LED</b>	>90 CRI, 3-Step MacAdam, 2700-4000K static white 3W - 15W per foot, 180 nominal lumens watt average, constant current Tunable white 2200-4000K, 80 nominal lumens per watt average RGBW, 50 nominal lumens per watt L70 (TM21 Projected 85C) Static White / Tunable White = 72,000 hours, RGBW = 50,000 hours
<b>Optic</b>	OD - Snap-in flush satin opal acrylic for even illumination
<b>Driver</b>	Compatible with quality constant current drivers
<b>Connectivity</b>	POE Wireless
<b>Weight</b>	5lbs per foot
<b>Operating Temp</b>	Suitable for operation in maximum ambient temperature of 35C (95F)
<b>Warranty</b>	5-year Limited (see complete company warranty information)
<b>Certifications</b>	ETL and ETL-C for dry and damp location, CE, Chicago plenum
<b>Voltages</b>	120-277VAC

## Lenses/Accessories

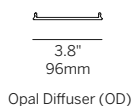

Recessed Plaster Trim (100LDL-RPT)

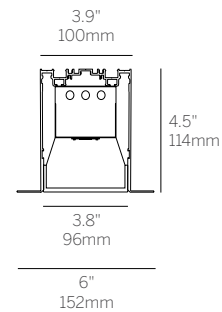
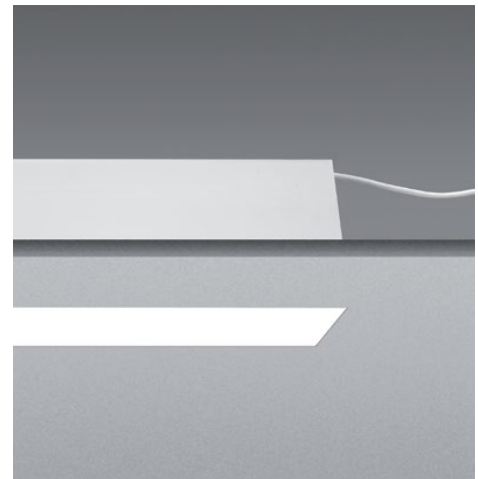

Recessed Bezel Trim / Grid Trim (100LDL-RBT/RGT)

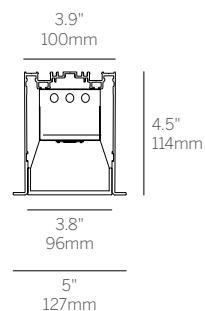

# 100 Linear Recessed Flush Lens

Model	Fixation	Pattern	Length	Power <sup>2</sup>	CRI/ CCT <sup>3</sup>	Driver <sup>5</sup>	Lens	Finish <sup>6</sup>	Options
WG-100LDL	RPT RBT RGT9 RGT15 RGTS	S P <sup>1</sup> PPI <sup>1</sup> PPO <sup>1</sup>	A A x B A x B x C A x B x A x B	P1 P2 P3 P4 M	927 930 935 940 TW <sup>4</sup> RGBW	E1 L1 POE BT DALI TQ DMX	OD (std)	W (std) B S F	CP EM NYC

## Model

- WG-100LDL = 100 Linear Recessed Downlight

## Fixation

- RPT = Recessed plaster trim
- RBT = Recessed bezel trim for hard ceiling
- RGT9 = Recessed trim for 9/16" grid
- RGT15 = Recessed trim for 15/16" grid
- RGTS = Recessed trim for slot grid

## Pattern

- S = Straight run
- P = Standard patterns 2, 3 or 4 sided with 90° corners on the same plane<sup>1</sup>
- PPI = Wall to ceiling / wall to wall, 90° inside corner<sup>1</sup>
- PPO = Wall to ceiling / wall to wall, 90° outside corner<sup>1</sup>
- PZ = Non-standard patterns and/or corners other than 90° on multiple planes, consult factory<sup>1</sup>

## Length

- A, B, C = specify inches to the nearest 0.25" (i.e. 72.25"). For patterns specify each length (i.e. 2 sided: A x B = 72.25" x 48"; 3 sided: A x B x C; 4 sided: A x B x A x B).

## Power<sup>2</sup>

- P1 = 3W/ft
- P2 = 6W/ft
- P3 = 10W/ft
- P4 = 15W/ft
- M = 7.6W/ft (RGBW Only)

## CRI/CCT (90+ CRI)<sup>3</sup>

- 927 = 2700K
- 930 = 3000K
- 935 = 3500K
- 940 = 4000K
- TW = Tuneable white 2200-4000K<sup>4</sup>
- RGBW = 3000K White

## Driver (Integral)<sup>5</sup>

- E1 = EldoLED 0.1% dimming, 0-10V (120-277V)
- L1 = Lutron 1% dimming, Ecosystem (120-277V)
- PoE = Power over Ethernet
- BT = Wireless CAS – Casambi (Must specify BT with E1 or DALI)
- DALI = EldoLED Dali DT8 0.1% (120-277V)
- TQ = T-Series for Lutron Quantum 0.1% (120-277V) (Tunable white ONLY)
- DMX = Osram+EldoLED, 24V, DMX Dimming (RGBW ONLY)

## Lens

- OD = Satin opal diffuser (standard diffuse)

## Finish<sup>6</sup>

- W = White, 15% gloss, RAL 9010 / Tiger Drylac 009/10120 (standard)
- B = Black, 15% gloss, RAL 9005 / Tiger Drylac 044/90053
- S = Silver, 15% gloss, RAL 9006 / Tiger Drylac 049/90500
- F = Custom finished trim, specify RAL

## Options

- CP = Chicago plenum
- EM = Emergency LED driver (remote only)
- NYC = 6' whip per run

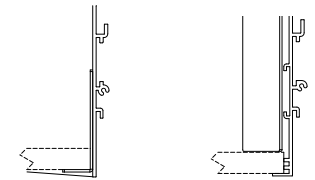

Plaster trim (RPT)

Recessed trim (RBT)

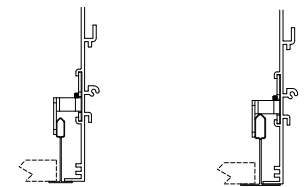

9/16" grid (RGT9)

15/16" grid (RGT15)

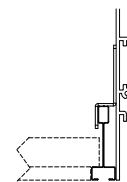

Slot grid (RGTS)

Whitegoods reserves the right to change any information without prior notice.

## Notes

- See pattern spec sheet.
- Wattage shown does not include power supplies/drivers.
- See spec page for delivered lumens.
- TW only available with P2 and P3.
- See power supply page for details.
- See Tiger Drylac color chart: [inter-lux.com/tiger](http://inter-lux.com/tiger)

index

technical  
information



# 100 Linear Suspended Flush Lens

- 4" aperture, integrated solution that is compatible with all ceiling types
- Standard and tailored run lengths, including corners in suspended configurations
- Flush lens for wide angle, even illumination
- Multiple control and connectivity options
- Consistent LED technology used throughout the Whitegoods product range
- Flexible design allows for installation from below with separate housing and gear tray for ease of installation and maintenance
- Flicker-free full range dimming with standard driver (Eldoled)
- Manufactured in the USA

<b>Housing</b>	Precision extruded aluminum for true dimensions and tolerances Snap-in flush lens for seamless integrated appearance Standard and tailored lengths including corners, wall-to-wall and wall-to-ceiling configurations Finishes: white, black, silver and custom
<b>Integration</b>	Ceiling canopy mounts to any ceiling surface
<b>Distribution</b>	High angle illumination linear downlight
<b>LED</b>	>90 CRI, 3-Step MacAdam, 2700-4000K static white 3W - 15W per foot, 180 nominal lumens per watt average, constant current Tunable white 2200-4000K, 80 nominal lumens per watt average RGBW, 50 nominal lumens per watt L70 (TM21 Projected 85C) Static White / Tunable White = 72,000 hours, RGBW = 50,000 hours t
<b>Optic</b>	OD - Snap-in flush satin opal acrylic for even illumination
<b>Driver</b>	Compatible with quality constant current drivers
<b>Connectivity</b>	POE Wireless
<b>Weight</b>	5lbs per foot
<b>Operating Temp</b>	Suitable for operation in maximum ambient temperature of 35C (95F)
<b>Warranty</b>	5-year Limited (see complete company warranty information)
<b>Certifications</b>	ETL and ETL-C for dry and damp location, CE, Chicago plenum
<b>Voltages</b>	120-277VAC

## Lenses/Accessories

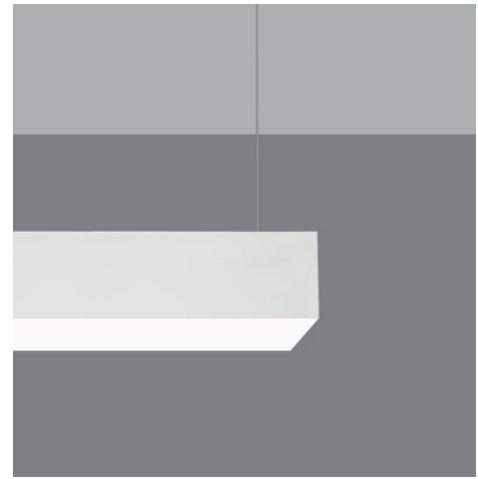
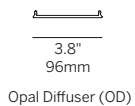

Suspended (100LDL)

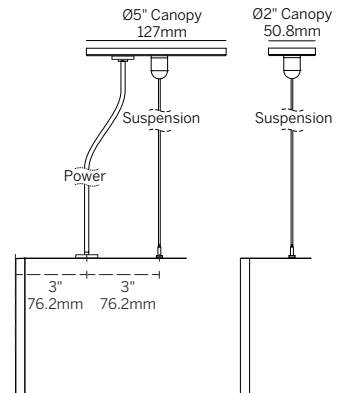
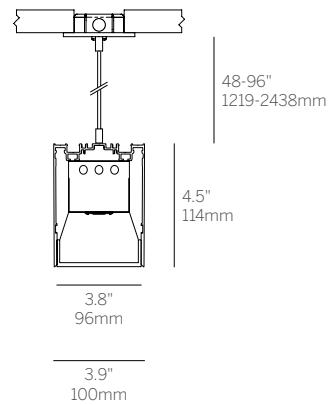

Power Feed + Suspension

# 100 Linear Suspended Flush Lens

Model	Fixation	Pattern	Length	Power <sup>2</sup>	CRI/ CCT <sup>3</sup>	Driver <sup>5</sup>	Lens	Finish <sup>6</sup>	Options
WG-100LDL	S48 S96 SXX	S P <sup>1</sup> PZ <sup>1</sup>	A A x B A x B x C A x B x A x B	P1 P2 P3 P4 M	927 930 935 940 TW <sup>4</sup> RGBW	E1 L1 POE BT DALI TQ DMX	OD (std)	W (std) B S F	EM

## Model

- WG-100LDL = 100 Linear Suspended Downlight

## Fixation

- S48 = 48" suspension cable, field-cuttable (standard)
- S96 = 96" suspension cable, field-cuttable
- SXX = Specify suspension cable length

## Pattern

- S = Straight run
- P = Standard patterns 2, 3 or 4 sided with 90° corners on the same plane<sup>1</sup>
- PZ = Non-standard patterns and/or corners other than 90° on multiple planes, consult factory<sup>1</sup>

## Length

- A, B, C = specify inches to the nearest 0.25" (i.e. 72.25"). For patterns specify each length (i.e. 2 sided: A x B = 72.25" x 48"; 3 sided: A x B x C; 4 sided: A x B x A x B).

## Power<sup>2</sup>

- P1 = 3W/ft
- P2 = 6W/ft
- P3 = 10W/ft
- P4 = 15W/ft
- M = 7.6W/ft (RGBW Only)

## CRI/CCT (90+ CRI)<sup>3</sup>

- 927 = 2700K
- 930 = 3000K
- 935 = 3500K
- 940 = 4000K
- TW = Tuneable white 2200-4000K<sup>4</sup>
- RGBW = 3000K White

## Driver (Integral)<sup>5</sup>

- E1 = EldoLED 0.1% dimming, 0-10V (120-277V)
- L1 = Lutron 1% dimming, Ecosystem (120-277V)
- PoE = Power over Ethernet
- BT = Wireless CAS – Casambi (Must specify BT with E1 or DALI)
- DALI = EldoLED Dali DT8 0.1% (120-277V)
- TQ = T-Series for Lutron Quantum 0.1% (120-277V) (Tunable white ONLY)
- DMX = Osram+EldoLED, 24V, DMX Dimming (RGBW ONLY)

## Lens

- OD = Satin opal diffuser (standard diffuse)

## Finish<sup>6</sup>

- W = White, 15% gloss, RAL 9010 / Tiger Drylac 009/10120 (standard)
- B = Black, 15% gloss, RAL 9005 / Tiger Drylac 044/90053
- S = Silver, 15% gloss, RAL 9006 / Tiger Drylac 049/90500
- F = Custom finished trim, specify RAL

## Options

- EM = Emergency LED driver (remote only)

Whitegoods reserves the right to change any information without prior notice.

## Notes

- 1 See pattern spec sheet.
- 2 Wattage shown does not include power supplies/drivers.
- 3 See spec page for delivered lumens.
- 4 TW only available with P2 and P3.
- 5 See power supply page for details.
- 6 See Tiger Drylac color chart: [inter-lux.com/tiger](http://inter-lux.com/tiger)

index

technical  
information



# 100 Linear Surface Flush Lens

- 4" aperture, integrated solution that is compatible with all ceiling types
- Standard and tailored run lengths, including corners, wall-to-wall and wall-to-ceiling configurations
- Flush lens for wide angle, even illumination
- Multiple control and connectivity options
- Consistent LED technology used throughout the Whitegoods product range
- Flexible design allows for installation from below with separate housing and gear tray for ease of installation and maintenance
- Flicker-free full range dimming with standard driver (Eldoled)
- Manufactured in the USA

<b>Housing</b>	Precision extruded aluminum for true dimensions and tolerances Snap-in flush lens for seamless integrated appearance Standard and tailored lengths including corners, wall-to-wall and wall-to-ceiling configurations Finishes: white, black, silver and custom
<b>Integration</b>	Fixation onto any surface such as gypsum, wood and all grid ceiling types
<b>Distribution</b>	High angle illumination linear downlight
<b>LED</b>	>90 CRI, 3-Step MacAdam, 2700-4000K static white 3W - 15W per foot, 180 nominal lumens per watt average, constant current Tunable white 2200-4000K, 80 nominal lumens per watt average RGBW, 50 nominal lumens per watt L70 (TM21 Projected 85C) Static White / Tunable White = 72,000 hours, RGBW = 50,000 hours
<b>Optic</b>	OD - Snap-in flush satin opal acrylic for even illumination
<b>Driver</b>	Compatible with quality constant current drivers
<b>Connectivity</b>	POE Wireless
<b>Weight</b>	5lbs per foot
<b>Operating Temp</b>	Suitable for operation in maximum ambient temperature of 35C (95F)
<b>Warranty</b>	5-year Limited (see complete company warranty information)
<b>Certifications</b>	ETL and ETL-C for dry and damp location, CE, Chicago plenum
<b>Voltages</b>	120-277VAC



Surface (100LDL-SM)

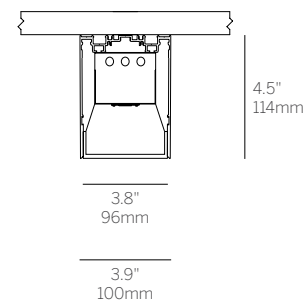

## Lenses/Accessories

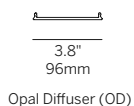



# 100 Linear Surface Flush Lens

Model	Fixation	Pattern	Length	Power <sup>2</sup>	CRI/ CCT <sup>3</sup>	Driver <sup>5</sup>	Lens	Finish <sup>6</sup>	Options
WG-100LDL	SM	S P1 PPI <sup>1</sup> PPO <sup>1</sup> PZ <sup>1</sup>	A A x B A x B x C A x B x A x B	P1 P2 P3 P4 M	927 930 935 940 TW <sup>4</sup> RGBW	E1 L1 POE BT DALI TQ DMX	OD (std)	W (std) B S F	EM

## Model

- WG-100LDL = 100 Linear Surface Downlight

## Fixation

- SM = Surface Mount

## Pattern

- S = Straight run
- P = Standard patterns 2, 3 or 4 sided with 90° corners on the same plane<sup>1</sup>
- PPI = Wall to ceiling / wall to wall, 90° inside corner<sup>1</sup>
- PPO = Wall to ceiling / wall to wall, 90° outside corner<sup>1</sup>
- PZ = Non-standard patterns and/or corners other than 90° on multiple planes, consult factory<sup>1</sup>

## Length

- A, B, C = specify inches to the nearest 0.25" (i.e. 72.25"). For patterns specify each length (i.e. 2 sided: A x B = 72.25" x 48"; 3 sided: A x B x C; 4 sided: A x B x A x B).

## Power<sup>2</sup>

- P1 = 3W/ft
- P2 = 6W/ft
- P3 = 10W/ft
- P4 = 15W/ft
- M = 7.6W/ft (RGBW Only)

## CRI/CCT (90+ CRI)<sup>3</sup>

- 927 = 2700K
- 930 = 3000K
- 935 = 3500K
- 940 = 4000K
- TW = Tuneable white 2200-4000K<sup>4</sup>
- RGBW = 3000K White

## Driver (Integral)<sup>5</sup>

- E1 = EldoLED 0.1% dimming, 0-10V (120-277V)
- L1 = Lutron 1% dimming, Ecosystem (120-277V)
- PoE = Power over Ethernet
- BT = Wireless CAS – Casambi (Must specify BT with E1 or DALI)
- DALI = EldoLED Dali DT8 0.1% (120-277V)
- TQ = T-Series for Lutron Quantum 0.1% (120-277V) (Tunable white ONLY)
- DMX = Osram+EldoLED, 24V, DMX Dimming (RGBW ONLY)

## Lens

- OD = Satin opal diffuser (standard diffuse)

## Finish<sup>6</sup>

- W = White, 15% gloss, RAL 9010 / Tiger Drylac 009/10120 (standard)
- B = Black, 15% gloss, RAL 9005 / Tiger Drylac 044/90053
- S = Silver, 15% gloss, RAL 9006 / Tiger Drylac 049/90500
- F = Custom finished trim, specify RAL

## Options

- EM = Emergency LED driver (remote only)

Whitegoods reserves the right to change any information without prior notice.

## Notes

- 1 See pattern spec sheet.
- 2 Wattage shown does not include power supplies/drivers.
- 3 See spec page for delivered lumens.
- 4 TW only available with P2 and P3.
- 5 See power supply page for details.
- 6 See Tiger Drylac color chart: [inter-lux.com/tiger](http://inter-lux.com/tiger)

index

technical  
information







# Photo Credits

## inside front cover - page 1

project 1600 Market Street  
location Philadelphia, PA  
architect Collective Architecture  
lighting design CM Kling  
photography Max Cuzumc

## page 4 - 5

project Venable LLP  
location Washington, DC  
architect Alliance Architecture  
lighting design MCLA  
photography Eric Laignel

## page 12, 22, 34 - 35, 94 - 95

project Elkrige Branch  
location Elkrige, MD  
architect Grimm + Parker  
photography Sam Kittner

## page 15

project Friends of the Earth  
location Washington, DC  
architect greg(g) horgan architecture  
photography Michael K. Wilkinson

## page 16 - 17, 76 - 77

project NCARB  
location Washington, DC  
architect OTJ Architects  
photography Trent Bell

## page 28 - 29

project St. Johns College High School  
location Chevy Chase, DC  
architect Perkins Eastman  
photography Andrew Rukke

## page 36

project Maidstone Museum  
location Maidstone, UK  
architect Hugh Broughton Architects  
lighting design AECOM

## page 39

project Laurel Library  
location Laurel, MD  
architect Grimm + Parker  
photography Michael K. Wilkinson

## page 40, 92 - 93

project Northern Virginia Community Colledge  
location Northern, VA  
architect Grimm + Parker  
photography Ken Wyner

## page 42

project 2330 N 2nd  
location Washington, DC  
architect Fox Architects  
photography James Oesch Photography

## page 44 - 45

project Rockville Town Center  
location Rockville, MD  
architect R2L:Architects, PLLC  
photography Steve Lerum, Inter-lux

## page 78 - 79

project MOI Inc.  
location Baltimore, MD  
architect Fox Architects  
photography Ron Blunt

## inside back cover

project Harrod Village at 121  
location Dallas, Texas  
architect O'Brien Architects  
photography Rockport Construction Group



The application of light to the surfaces around us is a critical factor in our perception of any space.

When proper consideration is given to the architecture, function and the desired atmosphere, lighting can become a truly integrated part of the overall environment being created, often unseen although defining and enhancing the space.