

20 Linear Overview

Linear Downlight

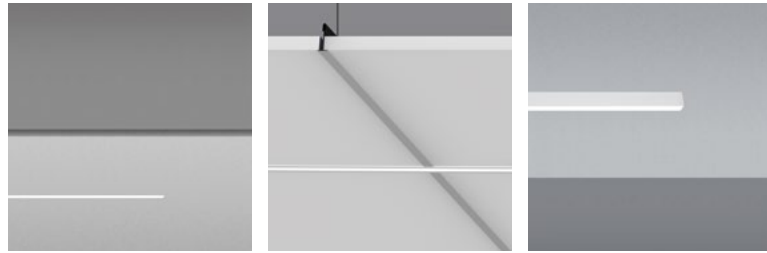

20 Linear Recessed Plaster Trim
20LDL-RPT

20 Linear Recessed Bezel Trim
20LDL-RBT

20 Linear Surface
20LDL-SM



20 Linear Surface Wall Mounted Direct/Indirect
20LDI-SW

20 Linear Suspended
20LDL-S

20 Linear Suspended Direct/Indirect
20LDI-S

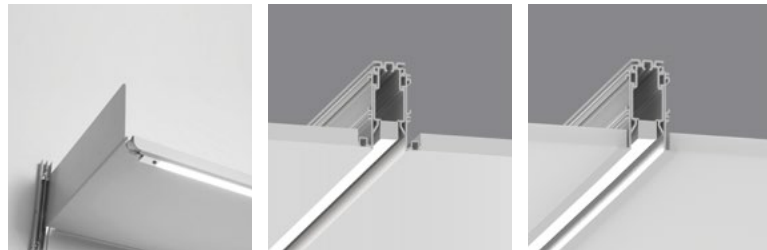

20 Linear Under Cabinet
20LUC-SM

20 Linear Recessed Flush Plaster Trim
20LRF-RPT

20 Linear Recessed Flush Bezel Trim
20LRF-RBT



20 Linear Recessed Flush Return Trim
20LRF-RRT

20 Linear Recessed Flush Grid Trim
20LRF-RGT

20 Linear Recessed Regressed Plaster Trim
20LRR-RPT

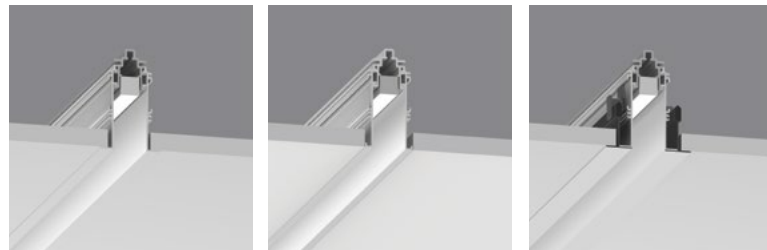

20 Linear Recessed Regressed Bezel Trim
20LRR-RBT

20 Linear Recessed Regressed Return Trim
20LRR-RRT

20 Linear Recessed Regressed Grid Trim
20LRR-RGT

Wall Wash

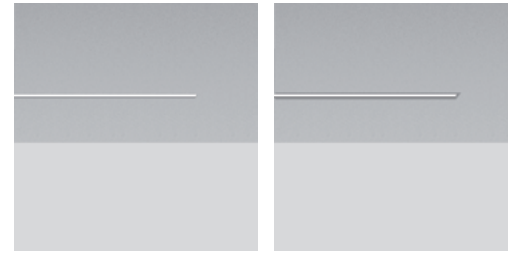

20 Linear Wash Light Recessed Plaster Trim
20LWW-RPT

20 Linear Wall Wash Recessed Bezel Trim
20LWW-RBT

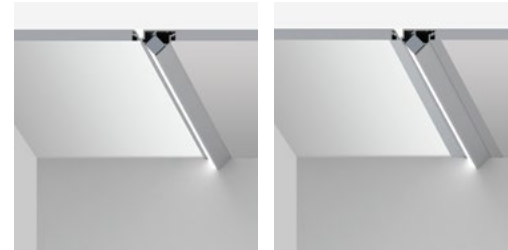

20 Linear Wash Light Semi-Recessed Plaster Trim
20LWW-SRPT

20 Linear Wash Light Semi-Recessed Bezel Trim
20LWW-SRBT



20 Linear Wash Light Semi-Recessed Plaster Trim
20LWW-SRPT

20 Linear Wash Light Semi-Recessed Bezel Trim
20LWW-SRBT

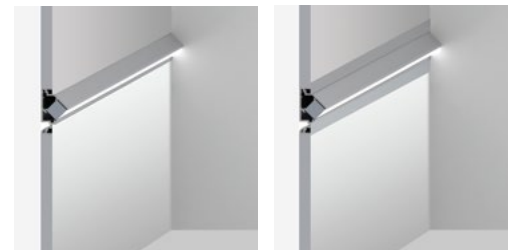

20 Linear Wash Light Semi-Recessed Plaster Trim
20LWW-SRPT

20 Linear Wash Light Semi-Recessed Bezel Trim
20LWW-SRBT

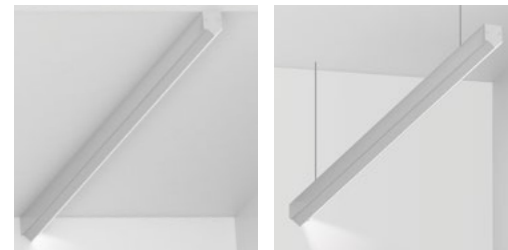

20 Linear Wash Light Surface
20LWW-SM

20 Linear Wash Light Suspended
20LWW-S

Perimeter

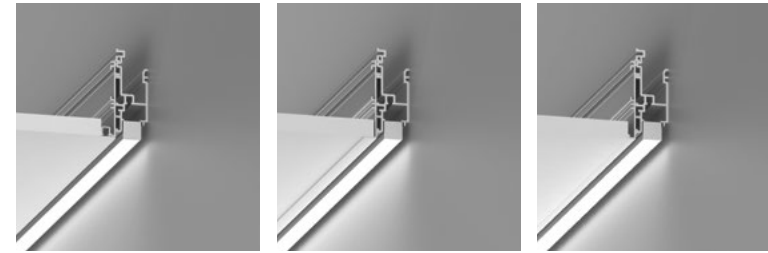

20 Linear Perimeter Flush Plaster Trim
20LPF-RPT

20 Linear Perimeter Flush Bezel Trim
20LPF-RBT

20 Linear Perimeter Flush Return Trim
20LPF-RRT

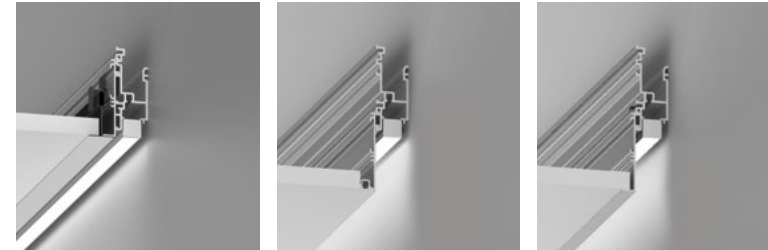

20 Linear Perimeter Flush Grid Trim
20LPF-RGT

20 Linear Perimeter Regressed Plaster Trim
20LPR-RPT

20 Linear Perimeter Regressed Bezel Trim
20LPR-RBT

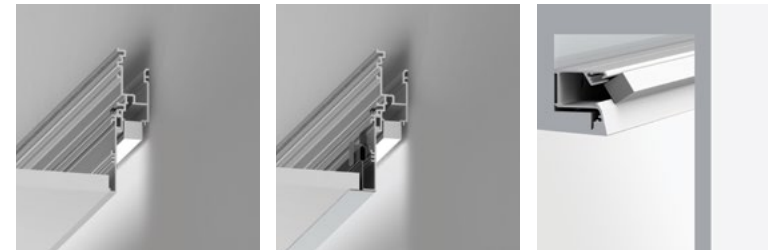

20 Linear Perimeter Regressed Return Trim
20LPR-RRT

20 Linear Perimeter Regressed Grid Trim
20LPR-RGT

20 Linear Mini Z Cove
20MZC-RPT

Cove



20 Linear Mini Edgeless Cove
20MEC-RPT

whitegoods
20 Linear Overview



inter•lux

Direct



20LDL-RPT
Plaster Trim
1-2-5



20LDL-RBT
Bezel Trim
1-2-5-6

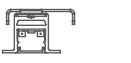

20LDL-RGT
Grid Trim
1-2-5-6



20LDL-SM
Surface
1-2-3-4-5-6-7

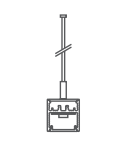

20LDL
Suspended
1-2-3-4-5-6-7

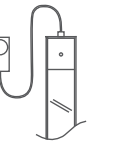

20LUC
Under Cabinet
1-2-5

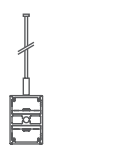

20LDI
Suspended
Direct/Indirect
1-2-3-4-5-6-7



20LDI-SW
Surface
Wall Mounted
Direct/Indirect
1-2-3-4-5

Direct/Indirect

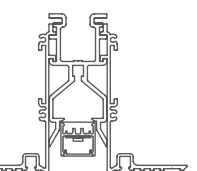

20LRF-RPT
Recessed Flush
Plaster Trim
1-2-3-4-5-6

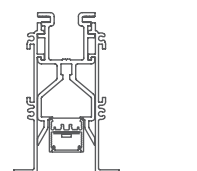

20LRF-RBT
Recessed Flush
Bezel Trim
1-2-3-4-5-6

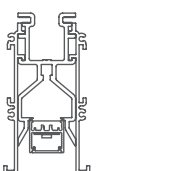

20LRF-RGT
Recessed Flush
Return Trim
1-2-3-4-5-6

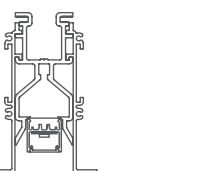

20LRF-RRT
Recessed Flush
Grid Trim
1-2-3-4-5-6

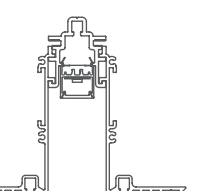

20LRR-RPT
Recessed Regressed
Plaster Trim
1-2-3-4-5

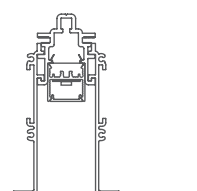

20LRR-RBT
Recessed Regressed
Bezel Trim
1-2-3-4-5

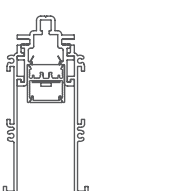

20LRF-RGT
Recessed Regressed
Return Trim
1-2-3-4-5

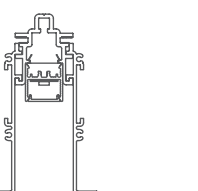

20LRF-RRT
Recessed Regressed
Grid Trim
1-2-3-4-5

Wash

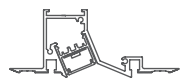

20LWW-RPT
Wash Light
Recessed
Plaster Trim
1-2-5

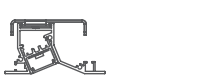

20LWW-RBT
Wash Light
Recessed
Bezel Trim
1-2-5



20LWW-SM
Wash Light
Surface
1-2-5

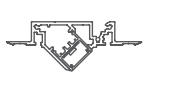

20LWW-SRPT
Wash Light
Semi-Recessed
Plaster Trim
1-2-5

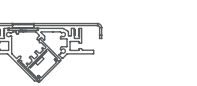

20LWW-SRBT
Wash Light
Semi-Recessed
Bezel Trim
1-2-5



20LWW
Wash Light
Suspended
1-2-5

Perimeter



20MZC
20 Linear
Mini Z Cove
1-2-5

Cove

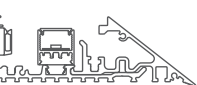

20MEC
20 Linear
Mini Edgeless Cove
1-2-5

NOMINAL LUMENS [lm / ft] CV1.2 STATIC WHITE				
CCT		POWER [W / ft]		
		L [3]	M [6]	H [10]
927		303	606	1061
930		330	659	1153
935		391	783	1370
940		465	930	1628
WD ¹		232	482	697
RGBW ²		-	-	394

1 WD: L = 2.7 W/ft, M = 5.5 W/ft, H = 7.6 W/ft
2 RGBW 8 W/ft, nominal lumens based on 3000K White LED

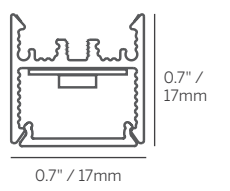

0.7" / 17mm

Perimeter

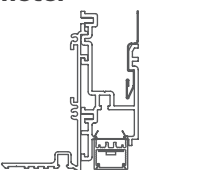

20LPF-RPT
Flush Plaster Trim
1-2-5

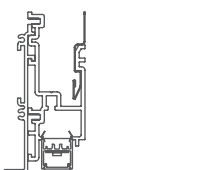

20LPF-RBT
Flush Bezel Trim
1-2-5

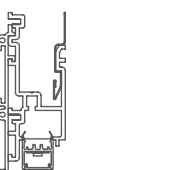

20LPF-RGT
Flush Return Trim
1-2-5

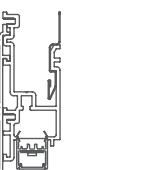

20LPF-RRT
Flush Grid Trim
1-2-5

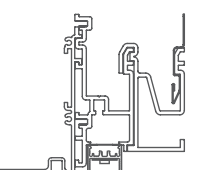

20LPFSG-RPT
Flush Plaster Trim
Soft-graze
1-2-5

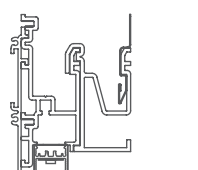

20LPFSG-RBT
Flush Bezel Trim
Soft-graze
1-2-5

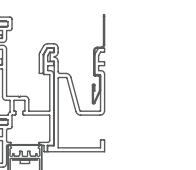

20LPFSG-RRT
Flush Return Trim
Soft-graze
1-2-5

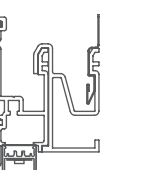

20LPFSG-RGT
Flush Grid Trim
Soft-graze
1-2-5

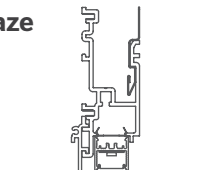

20LPR-RPT
Regressed Plaster Trim
1-2-3-4-5

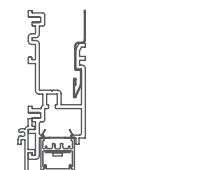

20LPR-RBT
Regressed Bezel Trim
1-2-3-4-5

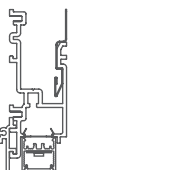

20LPR-RRT
Regressed Return Trim
1-2-3-4-5

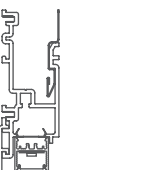

20LPR-RGT
Regressed Grid Trim
1-2-3-4-5

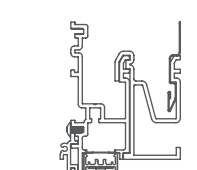

20LPRSG-RPT
Regressed Plaster Trim
Soft-graze
1-2-3-4-5

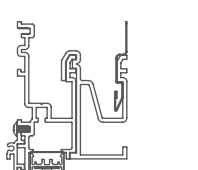

20LPRSG-RBT
Regressed Bezel Trim
Soft-graze
1-2-3-4-5

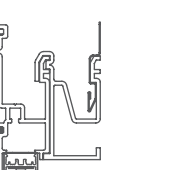

20LPRSG-RRT
Regressed Return Trim
Soft-graze
1-2-3-4-5

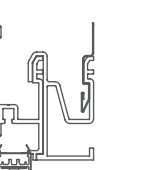

20LPRSG-RGT
Regressed Grid Trim
Soft-graze
1-2-3-4-5

1 = Opal Diffuser (OD)

2 = Satin Diffuser (SD)

3 = Narrow Lens (NL16)

4 = Louver (LL45)

5 = Micro-prismatic Lens (MPL)

6 = Block Diffuser (BD)

7 = Round Opal Diffuser (ROD)