



### Direct



20LDL-RPT  
Plaster Trim  
1-2-5



20LDL-RBT  
Bezel Trim  
1-2-5-6



20LDL-RGT  
Grid Trim  
1-2-5-6



20LDL-SM  
Surface  
1-2-3-4-5-6-7

### Direct/Indirect



20LDL  
Suspended  
1-2-3-4-5-6-7

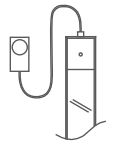

20LUC  
Under Cabinet  
1-2-5

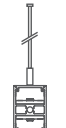

20LDI  
Suspended  
Direct/Indirect  
1-2-3-4-5-6-7



20LDI-SW  
Surface  
Wall Mounted  
Direct/Indirect  
1-2-3-4-5

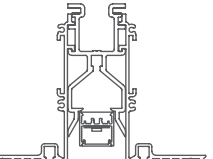

20LRF-RPT  
Recessed Flush  
Plaster Trim  
1-2-3-4-5-6

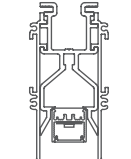

20LRF-RBT  
Recessed Flush  
Bezel Trim  
1-2-3-4-5-6

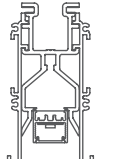

20LRF-RGT  
RECESSED FLUSH  
RETURN TRIM  
1-2-3-4-5-6

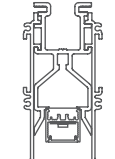

20LRF-RRT  
Recessed Flush  
Grid Trim  
1-2-3-4-5-6

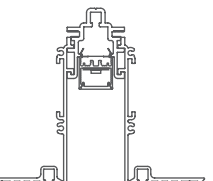

20LRR-RPT  
Recessed Regressed  
Plaster Trim  
1-2-3-4-5

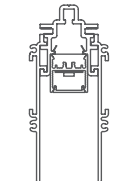

20LRR-RBT  
Recessed Regressed  
Bezel Trim  
1-2-3-4-5

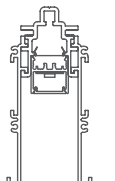

20LRF-RGT  
Recessed Regressed  
Return Trim  
1-2-3-4-5

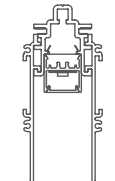

20LRF-RRT  
Recessed Regressed  
Grid Trim  
1-2-3-4-5

### Wash

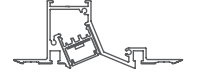

20LWW-RPT  
Wash Light  
Recessed  
Plaster Trim  
1-2-5

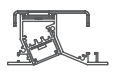

20LWW-RBT  
Wash Light  
Recessed  
Bezel Trim  
1-2-5



20LWW-SM  
Wash Light  
Surface  
1-2-5



20LWW-SRPT  
Wash Light  
Semi-Recessed  
Plaster Trim  
1-2-5

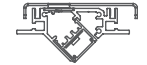

20LWW-SRBT  
Wash Light  
Semi-Recessed  
Bezel Trim  
1-2-5

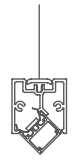

20LWW  
Wash Light  
Suspended  
1-2-5

### Perimeter

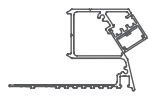

20MZC  
20 Linear  
Mini Z Cove  
1-2-5

### Cove

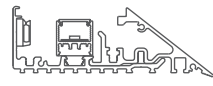

20MEC  
20 Linear  
Mini Edgeless Cove  
1-2-5

NOMINAL LUMENS [lm / ft] CV1.2 STATIC WHITE				
CCT	POWER [W / ft]			
	L [3]	M [6]	H [10]	
	927	303	606	1061
930	330	659	1153	
935	391	783	1370	
940	465	930	1628	
WD <sup>1</sup>	232	482	697	
RGBW <sup>2</sup>	-	-	394	

1 WD: L = 2.7 W/ft, M = 5.5 W/ft, H = 7.6 W/ft

2 RGBW 8 W/ft, nominal lumens based on 3000K White LED

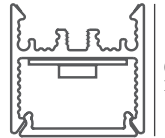

0.7" / 17mm

### Perimeter

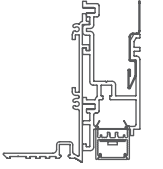

20LPF-RPT  
Flush Plaster Trim  
1-2-5

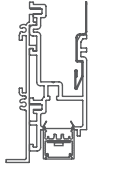

20LPF-RBT  
Flush Bezel Trim  
1-2-5

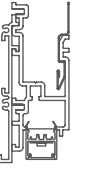

20LPF-RGT  
Flush Return Trim  
1-2-5

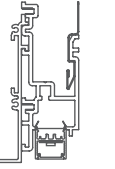

20LPF-RRT  
Flush Grid Trim  
1-2-5

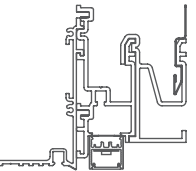

20LPFSG-RPT  
Flush Plaster Trim  
Soft-graze  
1-2-5

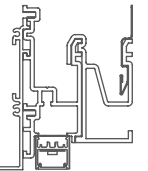

20LPFSG-RBT  
Flush Bezel Trim  
Soft-graze  
1-2-5

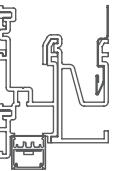

20LPFSG-RRT  
Flush Return Trim  
Soft-graze  
1-2-5

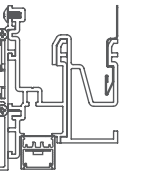

20LPFSG-RGT  
Flush Grid Trim  
Soft-graze  
1-2-5

### Graze

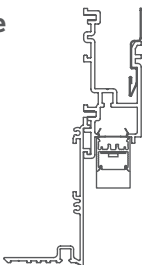

20LPR-RPT  
Regressed Plaster Trim  
1-2-3-4-5

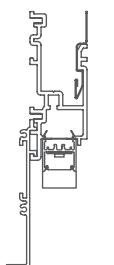

20LPR-RBT  
Regressed Bezel Trim  
1-2-3-4-5

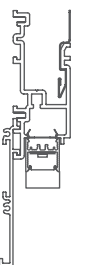

20LPR-RRT  
Regressed Return Trim  
1-2-3-4-5

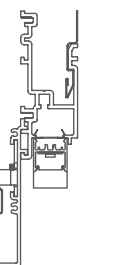

20LPR-RGT  
Regressed Grid Trim  
1-2-3-4-5

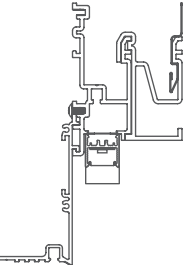

20LPRSG-RPT  
Regressed Plaster Trim  
Soft-graze  
1-2-3-4-5

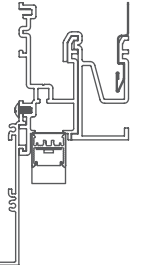

20LPRSG-RBT  
Regressed Bezel Trim  
Soft-graze  
1-2-3-4-5

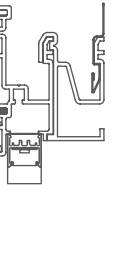

20LPRSG-RRT  
Regressed Return Trim  
Soft-graze  
1-2-3-4-5

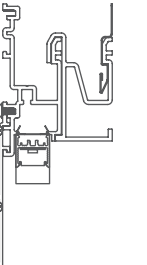

20LPRSG-RGT  
Regressed Grid Trim  
Soft-graze  
1-2-3-4-5