

ProTools 60 Linear

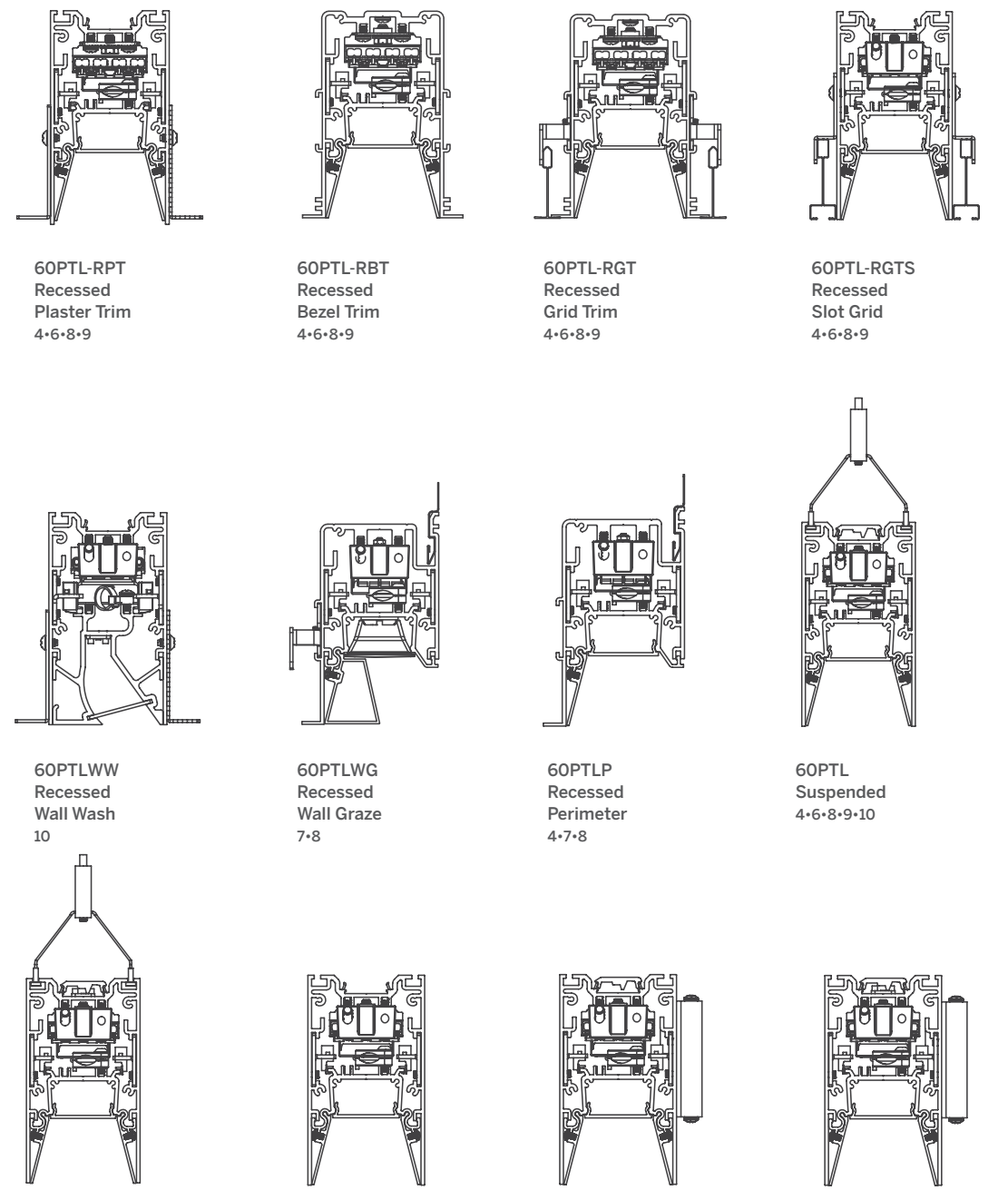

<p>60PTL-RPT Recessed Plaster Trim 4•6•8•9</p>	<p>60PTL-RBT Recessed Bezel Trim 4•6•8•9</p>	<p>60PTL-RGT Recessed Grid Trim 4•6•8•9</p>	<p>60PTL-RGTS Recessed Slot Grid 4•6•8•9</p>
<p>60PTLWW Recessed Wall Wash 10</p>	<p>60PTLWG Recessed Wall Graze 7•8</p>	<p>60PTLP Recessed Perimeter 4•7•8</p>	<p>60PTL Suspended Perimeter 4•6•8•9•10</p>
<p>60PTLDI Suspended Direct/ Indirect 4•6•8•9•10</p>	<p>60PTL-SM Surface Mount 4•6•7•8•9•10</p>	<p>60PTL-SW/SWM Wall / Mullion Mount 4•6•7•8</p>	<p>60PTLDI-SW/SWM Wall / Mullion Mount Direct/Indirect 4•6•7•8</p>

60 Linear Flush Lens

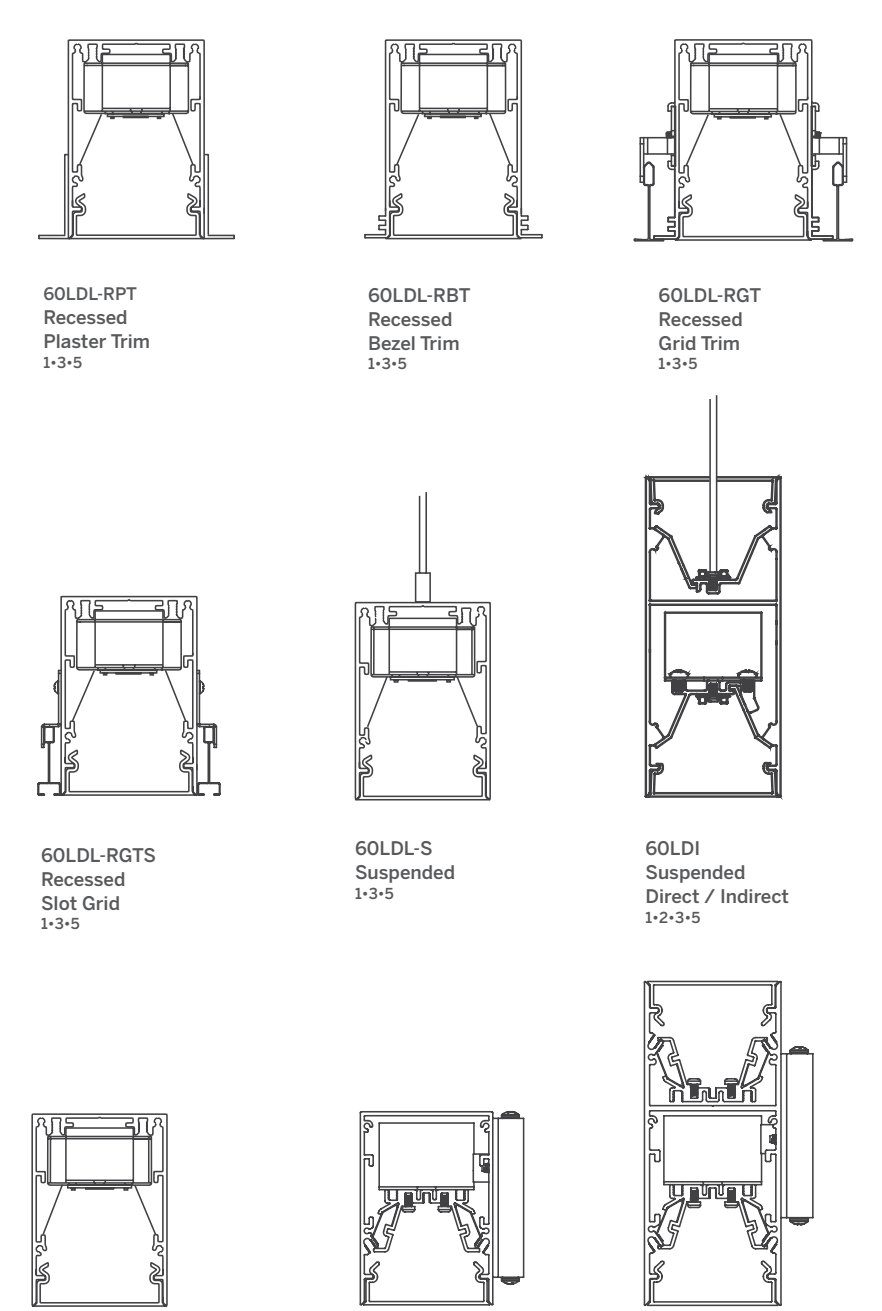





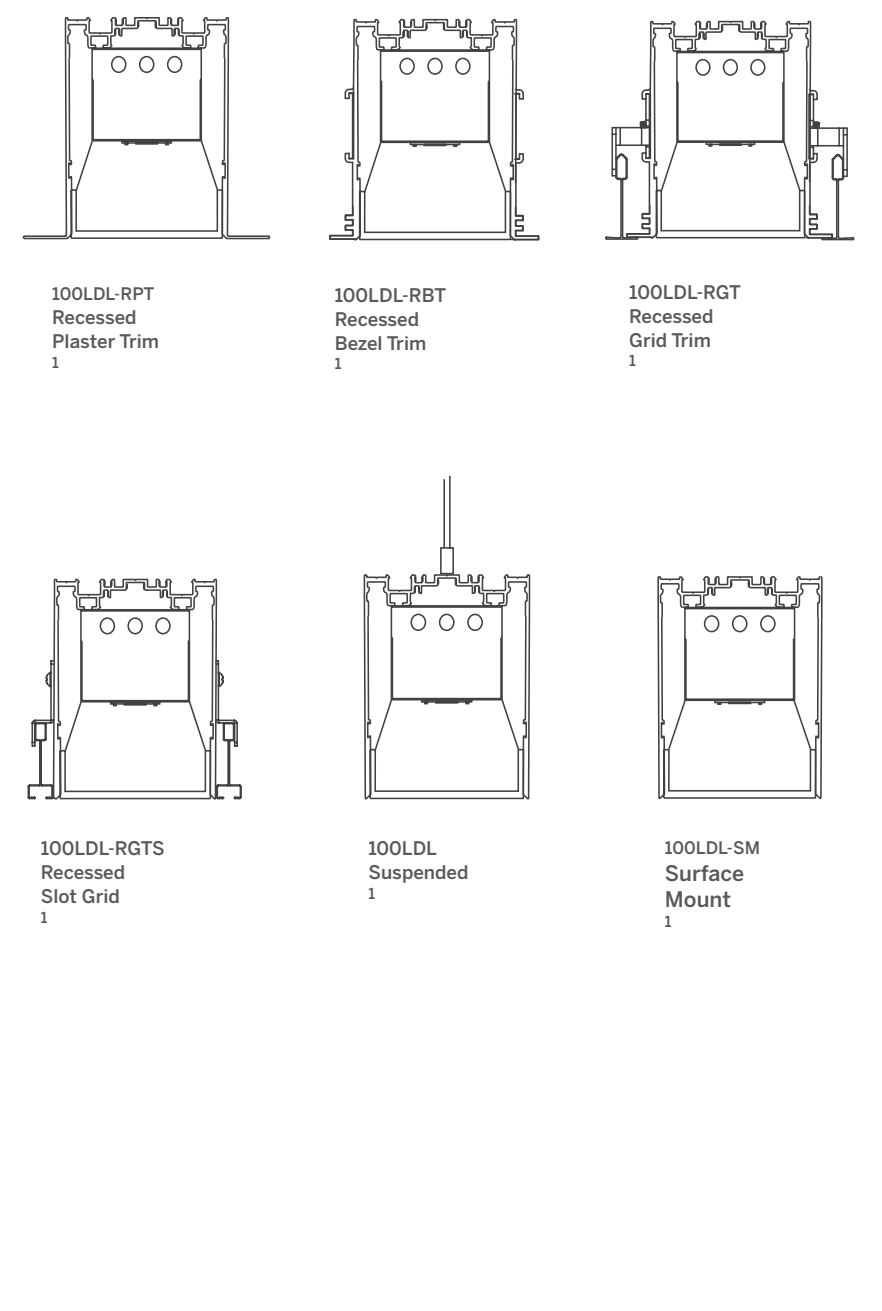

<p>60LDL-RPT Recessed Plaster Trim 1•3•5</p>	<p>60LDL-RBT Recessed Bezel Trim 1•3•5</p>	<p>60LDL-RGT Recessed Grid Trim 1•3•5</p>
<p>60LDL-RGTS Recessed Slot Grid 1•3•5</p>	<p>60LDL-S Suspended Perimeter 1•3•5</p>	<p>60LDI Suspended Direct / Indirect 1•2•3•5</p>
<p>60LDL-SM Surface Mount 1•3•5</p>	<p>60LDL/LDI-SW/SWM Mullion Mount Direct or Indirect 1•2•3</p>	<p>60LDL/LDI-SW/SWM Mullion Mount Direct / Indirect 1•2•3</p>

100 Linear Flush Lens



<p>100LDL-RPT Recessed Plaster Trim 1</p>	<p>100LDL-RBT Recessed Bezel Trim 1</p>	<p>100LDL-RGT Recessed Grid Trim 1</p>
<p>100LDL-RGTS Recessed Slot Grid 1</p>	<p>100LDL Suspended Perimeter 1</p>	<p>100LDL-SM Surface Mount 1</p>

-  1 = Opal Diffuser (OD)
-  2 = Satin Diffuser (SD)
-  3 = Micro-prismatic Lens (MPL)
-  4 = Recessed Micro-prismatic (RML)
-  5 = Drop Diffuser (DD)
-  6 = Regressed Opal Lens (ROL)
-  7 = Recessed Elliptical Optic (REO)
-  8 = Recessed Louver (RLW/RLB)
-  9 = Recessed Narrow Optic (RNO)
-  10 = Linear Micro-prismatic (LML)