

# Constant Voltage drivers

## Wiring Key Points

1. This product shall be installed by a qualified electrician.
2. Make sure the main power supply to the driver is turned off when wiring either the LEDs or driver.
3. LEDs shall be wired in parallel as shown in wiring diagram. CAUTION: incorrect wiring may damage LEDs.
4. Wire shall be #18AWG stranded minimum. Large gauge wire shall be used to limit voltage drop in order to maintain the proper operating voltage. Take every precaution to avoid interference from other electrical circuits and equipment.
5. Dimming circuits are more sensitive to voltage drop and electrical interference from other electrical sources.
6. Isolating LED wiring by dedicated circuit for each control zone is recommended.
7. Contractor shall verify the fixture quantities connected to the driver are compatible with the driver's specifications prior to energizing the circuit.
8. All Class II power cable remote wiring by others.

**LED's can be permanently damaged if these points are not followed**

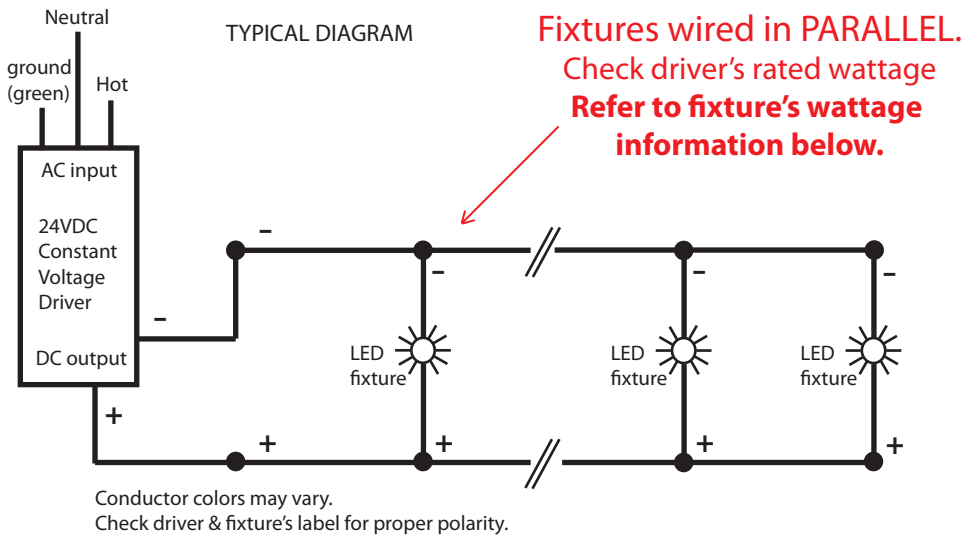

Maximum wiring distance\*

Wire gauge	Load per driver		
	≤48W	≤72W	≤96W
#18AWG	37'	25'	18'
#16AWG	59'	39'	29'
#14AWG	95'	63'	47'
#12AWG	151'	101'	75'
#10AWG	241'	160'	120'

\* Voltage drop guide for 24VDC. Actual Voltage drop to be calculated by installer.

Fixture

Nominal Length

Watts/fixture

Please note: Dimming/control wiring not shown in the diagram above for the OT96W /24V/ UNV/DIM dimmable driver. A relay or Powerpack may be required. Running separate line side (line voltage) and controls (low voltage) leads may be required. Refer to the NEC, your local jurisdiction and the 0-10V dimmer or dimming system manufacturer you are planning on using for additional considerations on how to wire the 0-10V control leads.

**inter•lux**

Project:	Type:	Date:
Manufacturer: <b>LINEALIGHT</b>	Fixture:	Page: 1 OF 3

# Inter-Lux

## Sylvania Optotronic® Constant Voltage Electronic 24V DC LED Power Supplies

### Ordering Information

Inter-lux  
part #

Qty.	Ordering Abbreviation	Nominal Input Voltage (V)	Nominal Input Current (A)	Power Factor	Output Power Range (W)	Dimming Mode	Dimming Control	Dimming Range	Location Rating	Item Number
OT96-D010	OT96W/24V/UNV/DIM ←	120 277	0.97 0.39	0.9	1-96	PWM	0-10V DC	10-100%	Damp	51520
OT96-JBX	OT96W/24V/UNV/JBX	120 277	0.91 0.39	0.99	0.8-96	n/a	n/a	n/a	Wet <sup>2</sup>	51626

#### Notes:

- All power supplies can be remote mounted up to 32 feet. Although it is possible to exceed the remote mounting distance, the installer and/or end user must take precautions to prevent and/or test the effects of EMI (electromagnetic interference).
- Use wiring rated and marked PLTC, CL3R, and "sun resistant"

### Minimum and Maximum Ratings

Parameter	Power Supply	Values
Ambient Temperature Range	OT96 DIM OT96JBX	-20°C through +40°C -30°C through +70°C

### Case dimensions

OT96-DIM Case:

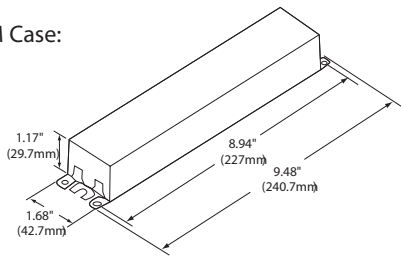

OT96-JBX Case:  
(Wet Rated)

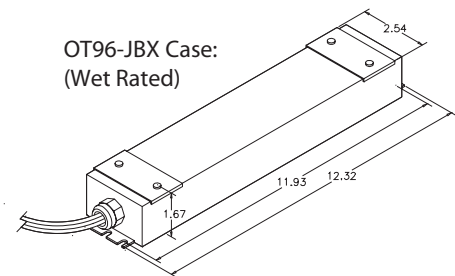

Input: wires with a UL Listed, 1/2" metallic fitting  
Output: wires with a UL Listed, 1/2" plastic fitting

### Wiring Diagrams

OT96DIM only:

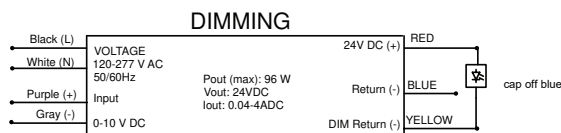
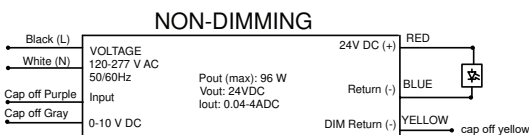

**WARNING:** if not connected to a 0-10V dimmer, driver MUST be wired as Non-dim. Not doing so can cause the driver and the fixtures to fail prematurely.

OT96JBX:

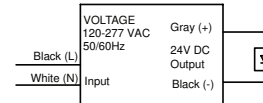

#### Specifications and Certifications

OT96DIM (NAED 51520): UL 1310, UL48  
Recognized for US & Canada Class 2 Unit

OT96 (NAED 51626):  
UL48 Listed for US & Canada Class 2 Unit



Driver supplied in this Dry location enclosure:

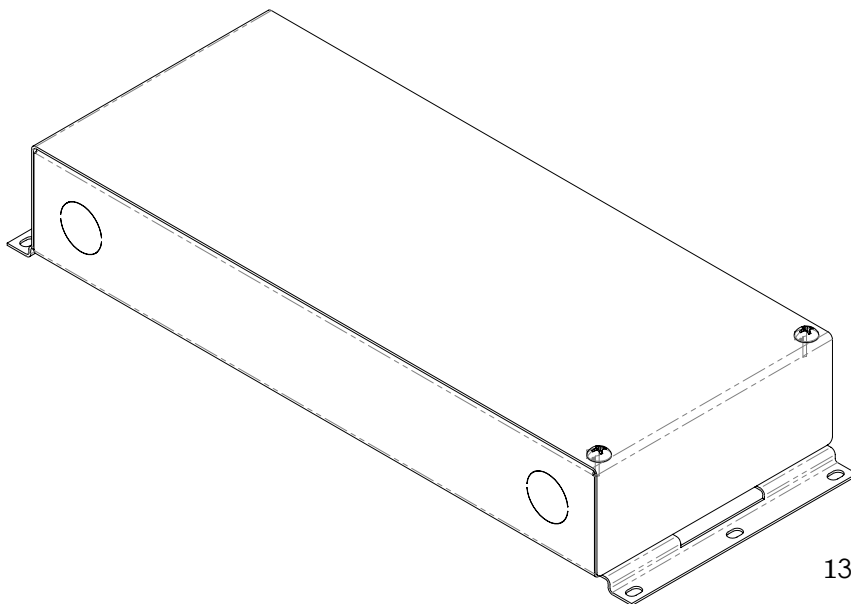

13.25" (L) x 5" (W) x 2.25" (H)  
*surface mount in any orientation*

## SPECIFICATIONS

---

### Construction

Formed aluminum construction.

All models feature several conveniently located trade size knock-outs (K.O.'s).

### Remote Distance

Consult factory for recommended maximum remote mounting distance.

### Finishes

Standard finish is milled aluminum to provide heat dissipation.