

# ProTools 3" Downlights

## WG-75PTRWW-RPT / WG-75PTSWW-SPT

# Plaster Trim Wall Wash Installation Instructions

Luminaires must be installed by a qualified electrician (check with local and national codes for proper installation).



To prevent electrical shock, disconnect electrical supply before installation or servicing. Never connect a live fixture!!!

Contractor is responsible for adequately reinforcing walls and/or ceilings to support fixture weight. Provide blocking when necessary.

**Step 1** Cut the appropriate size opening in the ceiling and clear any insulation at least 3" from any part of the Fixture or Driver Enclosure. Screw the Frame into ceiling blocking or structure and plaster in the Frame.

**Note:** For Wet Location, strip the paper from the gasket and attach the Gasket to the inside trim before installation. For Dry, remove the Gasket.

ROUND

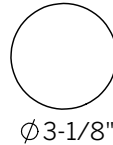
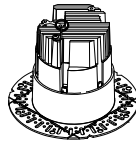

SQUARE

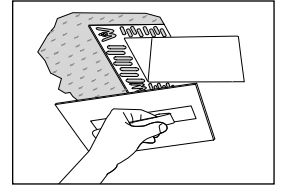
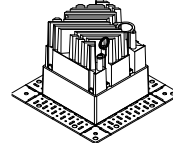

Install using 'tape-and-joint' method, or plaster finish. Clean excess plaster while still wet.

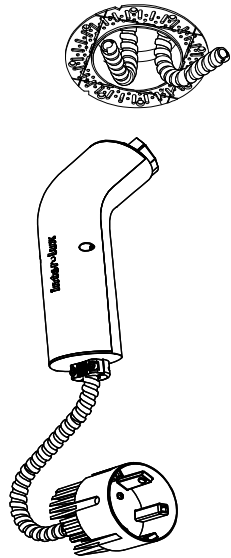

Conduit by others

**Step 2** Pull Power Cable and Control Cable through the ceiling opening.

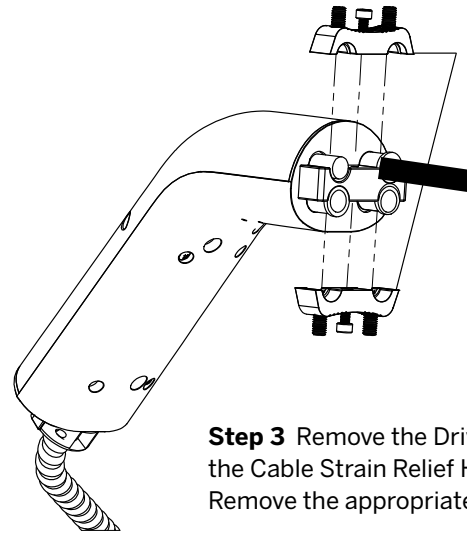

**Step 3** Remove the Driver Box cover. Loosen the Cable Strain Relief Hex Screws and Bracket. Remove the appropriate knock-outs.

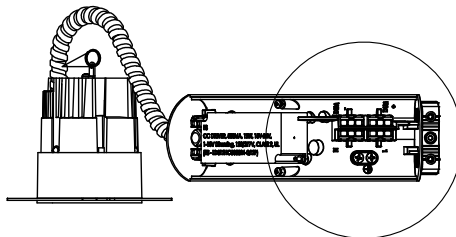

**Step 4** Connect the Feed Cable to the Black (L), White (N) and Green (Gnd) Terminals. Connect the Dimming Conductors, if applicable.

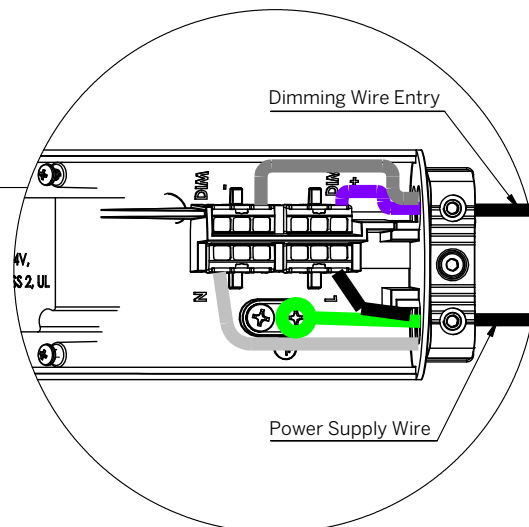

NOTES:  
Driver Box allows Through-Wiring of power and control.  
Use 7/64" allen key to fix set screws.  
Fasten set screws provided to secure the cables as shown.

# ProTools 3" Downlights

WG-75PTRWW-RPT / WG-75PTSWW-SPT

## Plaster Trim Wall Wash Installation Instructions

**Step 5** Add the hanging ceiling wire (by others) looping it through the ring on the Fixture Insert to connect to structure.

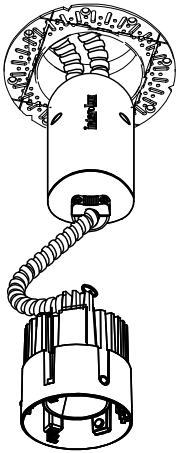
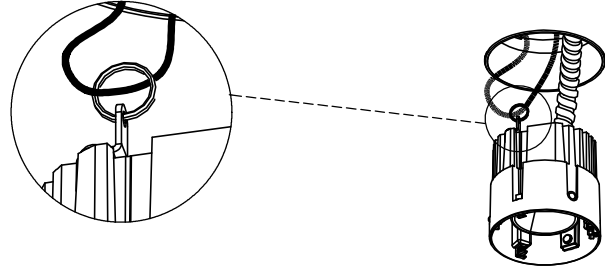

**Step 6** Insert the Driver Housing through the Frame.

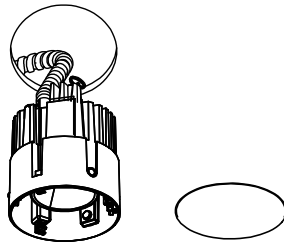

**Step 7** Push the Cover into the Insert and snap into place.

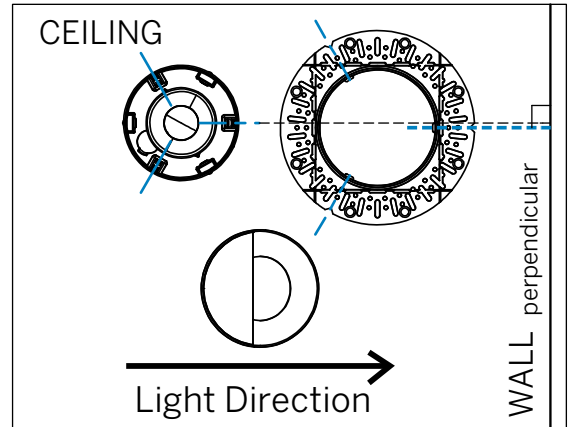

**Step 8** Push the Cover into the Insert and Snap into place observing the light orientation.

**Cover Installation** Cover should be inserted by level alignment so the (4) Touch Latches engage and hold the Cover into place. If the Cover does not engage, make sure that the Touch Latches are all OPEN (extended). When the Cover engages the Touch Latches they will be CLOSED (recessed). To remove Cover, push upward evenly and downward to release Touch Latch.

