

## PATTERN INSIDE (PI)

WG-ZC-RPT-PI-...

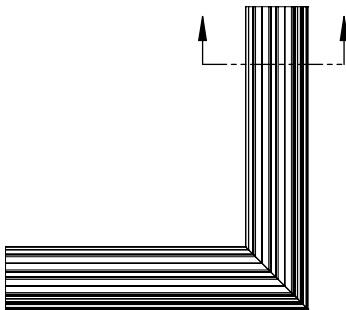

TOP VIEW

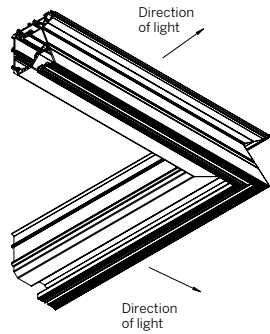
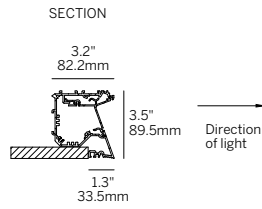

Minimum Angle 45°  
Maximum Angle 180°

## PATTERN OUTSIDE (PO)

WG-ZC-RPT-PO-...

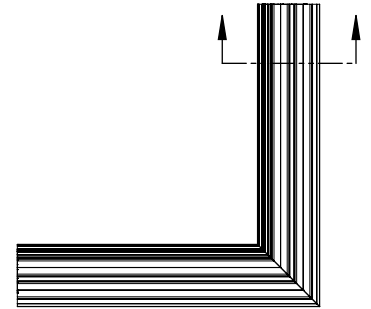

TOP VIEW

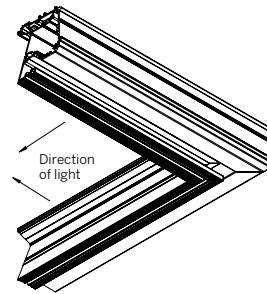
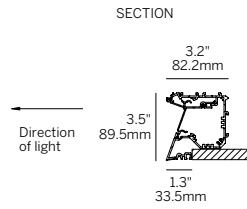

## PATTERN INSIDE (PI)

WG-ZC-RBT-PI-...

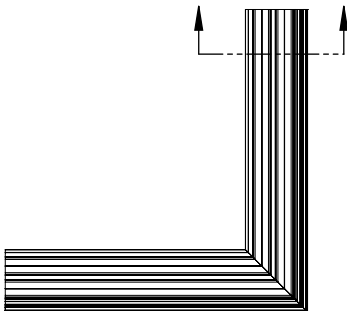

TOP VIEW

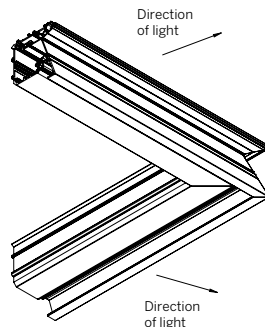
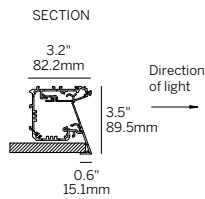

Minimum Angle 45°  
Maximum Angle 180°

## PATTERN OUTSIDE (PO)

WG-ZC-RBT-PO-...

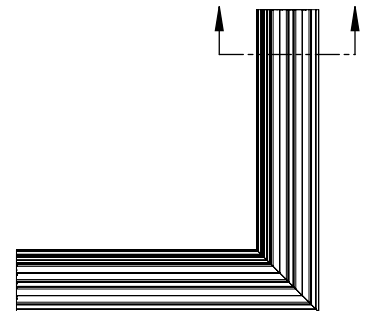

TOP VIEW

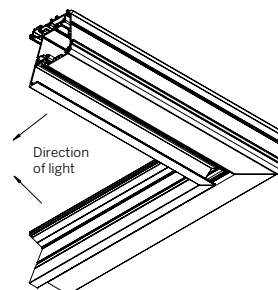
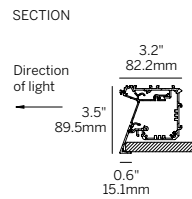

## CORNER + STRAIGHT RUN CONNECTIONS

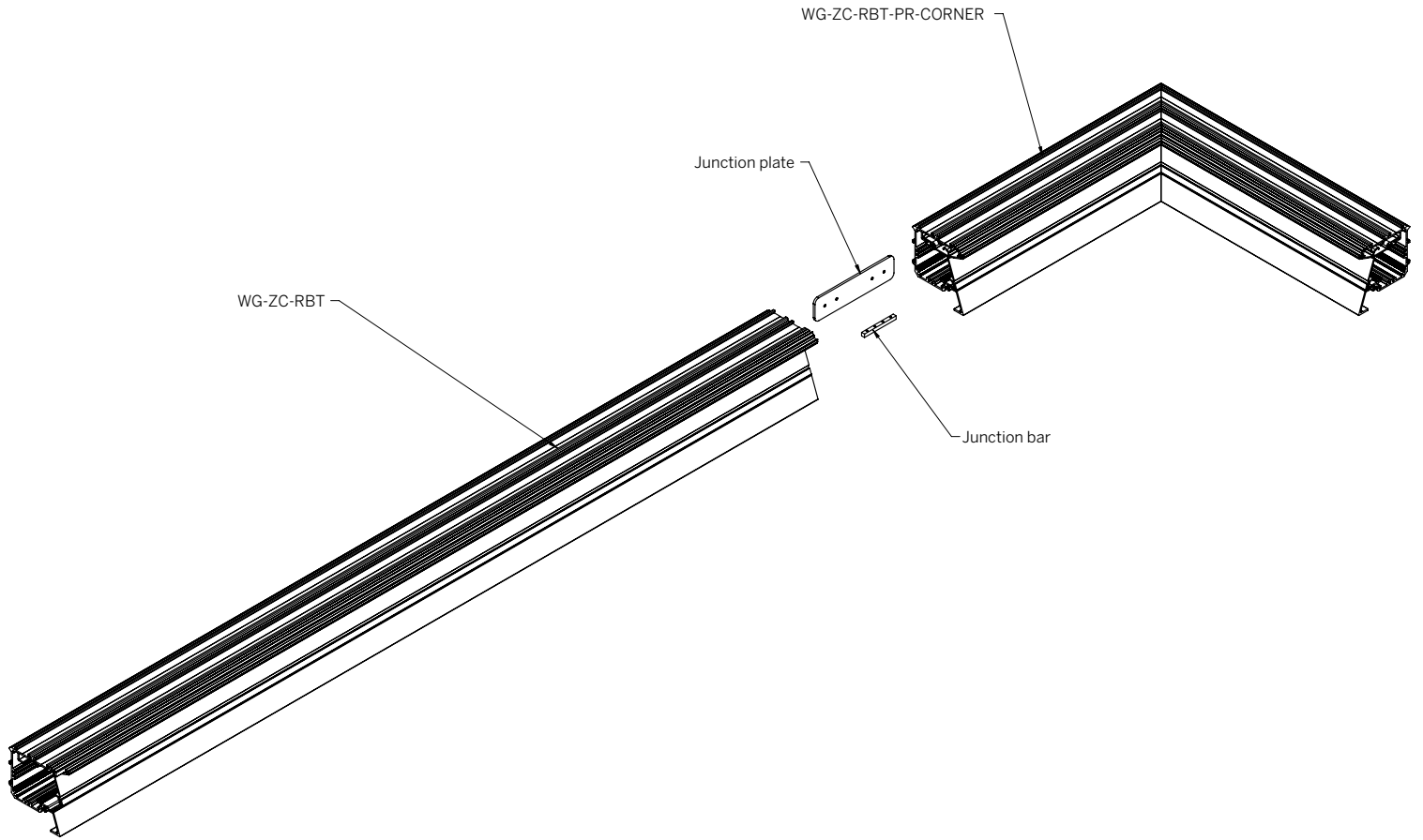

## MOUNTING

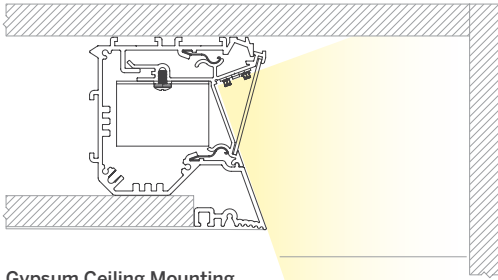

Gypsum Ceiling Mounting

2.5" minimum offset,  
12" typical offset

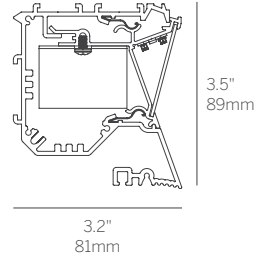

Plaster Trim (RPT)

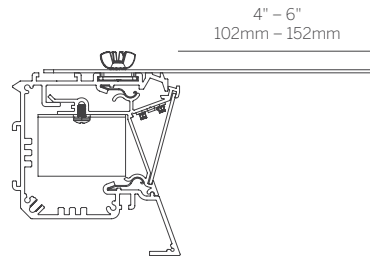

Bezel Trim (RBT)

Shown with optional in-fill panel

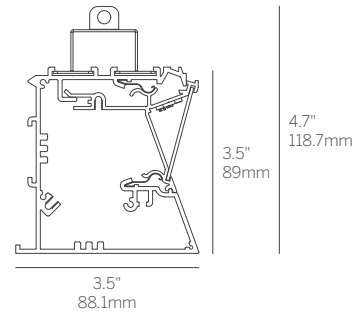

Grid Trim (RGT9, RGT15)