

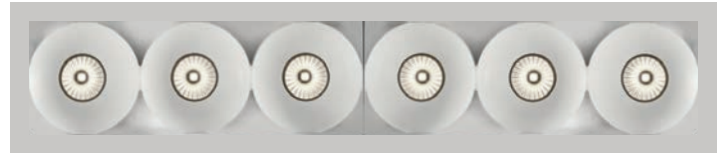

# cell range

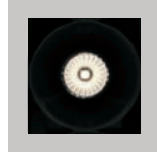
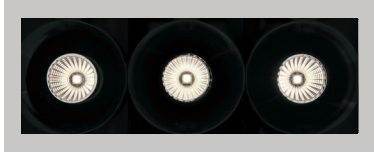
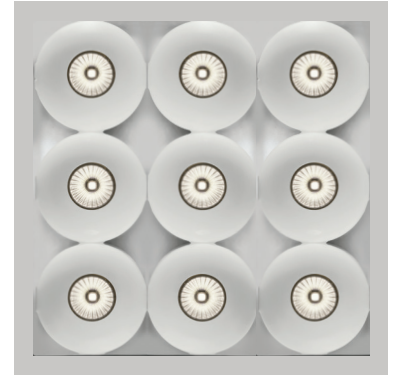
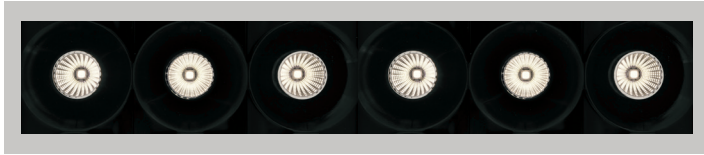

	1 x powerLED	3 x powerLEDs	6 x powerLEDs	9 x powerLEDs
<b>Gypsum_Cell</b>	3 x 3 in	5.9 x 3 in	10.2 x 3 in	5.9 x 5.9 in
<b>Cell</b>	2 x 2 in	4.7 x 2 in	8.7 x 2 in	4.7 x 4.7 in
<b>Power</b>	2 W 4 W	6 W 12 W	10 W	18 W
<b>Finish</b>	<input type="checkbox"/> <input type="checkbox"/>	<input type="checkbox"/> <input type="checkbox"/>	<input type="checkbox"/> <input type="checkbox"/>	<input type="checkbox"/> <input type="checkbox"/>
<b>CRI 92</b> <b>CRI 80</b>	2700K 3000K 3500K 4000K	2700K 3000K 3500K 4000K	2700K 3000K 3500K 4000K	2700K 3000K 3500K 4000K
<b>Optics</b>	Spot Medium Flood Flood	Spot Medium Flood Flood	Spot Medium Flood Flood	Spot Medium Flood Flood
<b>Driver</b>	On/Off 0-10V	On/Off 0-10V	On/Off 0-10V	On/Off 0-10V
	3.4 x 3.4 in (Gypsum_Cell) 1.6 x 1.6 in (Cell)	6.3 x 3.5 in (Gypsum_Cell) 4.5 x 1.6 in (Cell)	10.6 x 3.5 in (Gypsum_Cell) 8.5 x 1.6 in (Cell)	6.3 x 6.3 in (Gypsum_Cell) 4.5 x 4.5 in (Cell)

### Visual comfort

The circular-shaped cut-off cells represent the interface between the optics and the ceiling; thanks to the particular angle, they can control luminance in combination with the reflectors guaranteeing a professional result.

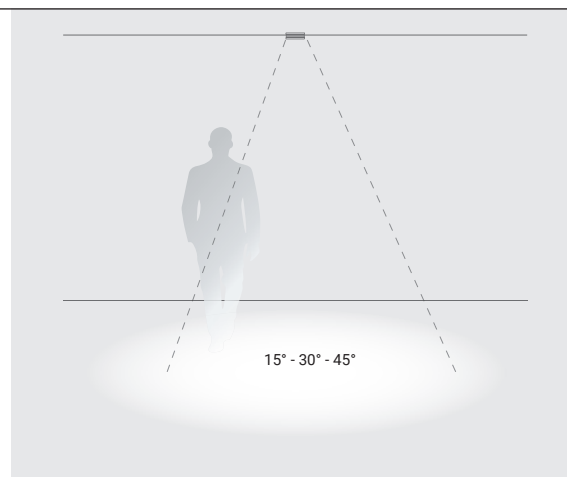

### Micro-optics CELL

The particular wire mesh with convex faces that characterises the surface of the micro reflectors is capable of controlling each light beam defining an emission available in 15°, 30° and 45°.

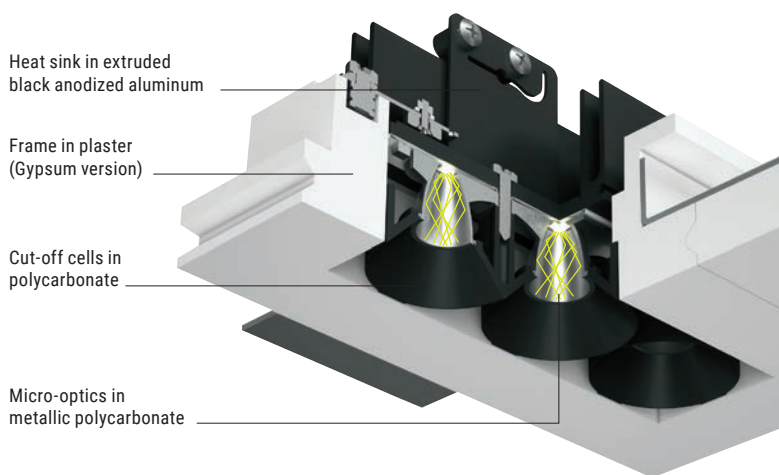

### Extensiveness of the range of products

The Cell and Gypsum\_Cell range of products now come with new versions, conceived to meet several lighting technology needs. The new one-cell single recessed casing joins the three and six-cell options arranged linearly and squared with nine modules. The one and three-cell versions with doubled power and more performing, complete the range of products.

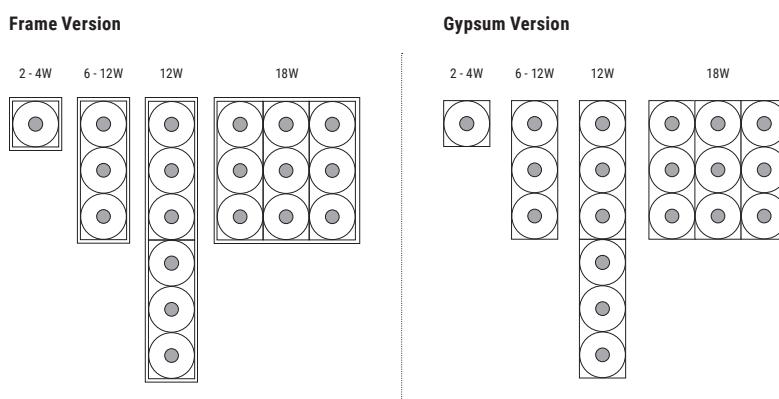

### Quick installation

The Gypsum\_Cell comes with a recessed casing with plaster frame, conceived for installation on dropped ceiling. The magnet-equipped quick coupling system allows to easily position the light units that can be painted, for full integration with the architecture.

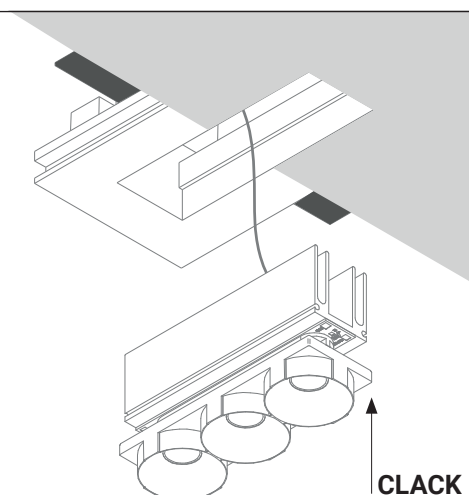

Cell | Downlights | powerLED | Driver remote | 2W 630mA



CRI 80\*/92

White	<b>E64507</b>	2700 K	157 lm	<b>M</b>	Spot	<b>15</b>
Wh Bk	<b>E64508</b>	3000 K	179 lm	<b>W</b>	Medium Flood	<b>30</b>
		3500 K	179 lm	<b>T</b>	Flood	<b>45</b>
		4000 K*	249 lm	<b>N</b>		

Power supply options (remote only)

<b>ECO30W-630</b> 0-10V EldoLED ECOdrive 30W for 1-10 fixtures	<b>SOLO50W-630</b> 0-10V EldoLED SOLOdrive 50W for 1-16 fixtures	<b>SOLO100W-630</b> 0-10V EldoLED SOLOdrive 100W for 1-32 fixtures
---	---	---



Cell | Downlights | 3 x powerLEDs 2W | Driver remote | 6W 630mA

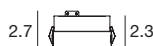
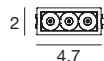

CRI 80\*/92

White	<b>E64541</b>	2700 K	471 lm	<b>M</b>	Spot	<b>15</b>
Wh Bk	<b>E64540</b>	3000 K	537 lm	<b>W</b>	Medium Flood	<b>30</b>
		3500 K	537 lm	<b>T</b>	Flood	<b>45</b>
		4000 K*	747 lm	<b>N</b>		

Power supply options (remote only)

<b>ECO30W-630</b> 0-10V EldoLED ECOdrive 30W for 1-3 fixtures	<b>SOLO50W-630</b> 0-10V EldoLED SOLOdrive 50W for 1-6 fixtures	<b>SOLO100W-630</b> 0-10V EldoLED SOLOdrive 100W for 1-12 fixtures
--	--	---



Cell | Downlights | 6 x powerLEDs 2W | Driver remote | 12W 630mA

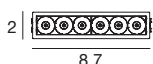

CRI 80\*/92

White	<b>E64543</b>	2700 K	942 lm	<b>M</b>	Spot	<b>15</b>
Wh Bk	<b>E64542</b>	3000 K	1074 lm	<b>W</b>	Medium Flood	<b>30</b>
		3500 K	1074 lm	<b>T</b>	Flood	<b>45</b>
		4000 K*	1494 lm	<b>N</b>		

Power supply options (remote only)

<b>ECO30W-630</b> 0-10V EldoLED ECOdrive 30W for 1-2 fixtures	<b>SOLO50W-630</b> 0-10V EldoLED SOLOdrive 50W for 1-2 fixtures	<b>SOLO100W-630</b> 0-10V EldoLED SOLOdrive 100W for 1-4 fixtures
--	--	--



Cell | Downlights | 9 x powerLEDs 2W | Driver remote | 18W 630mA



CRI 80\*/92

White	<b>E64545</b>	2700 K	1413 lm	<b>M</b>	Spot	<b>15</b>
Wh Bk	<b>E64544</b>	3000 K	1611 lm	<b>W</b>	Medium Flood	<b>30</b>
		3500 K	1611 lm	<b>T</b>	Flood	<b>45</b>
		4000 K*	2241 lm	<b>N</b>		

Power supply options (remote only)

<b>ECO30W-630</b> 0-10V EldoLED ECOdrive 30W for 1 fixture	<b>SOLO50W-630</b> 0-10V EldoLED SOLOdrive 50W for 1-2 fixtures	<b>SOLO100W-630</b> 0-10V EldoLED SOLOdrive 100W for 1-4 fixtures
---	--	--



Cell | Downlights | powerLED | Driver remote | 4W 350mA

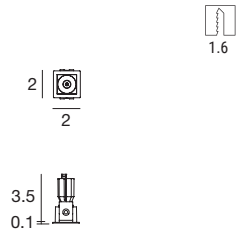

CRI 80

White	<b>E64526</b>	2700 K	490 lm	<b>M</b>	Spot	<b>15</b>
Wh Bk	<b>E64527</b>	3000 K	490 lm	<b>W</b>	Medium Flood	<b>30</b>
		3500 K	490 lm	<b>T</b>	Flood	<b>45</b>
		4000 K	529 lm	<b>N</b>		

Power supply options (remote only)

**ECO30W-350**

0-10V EldoLED ECOdrive  
30W  
for 1-3 fixtures

**SOLO50W-350**

0-10V EldoLED  
SOLOdrive 50W  
for 1-6 fixtures

**SOLO100W-350**

0-10V EldoLED  
SOLOdrive 100W  
for 1-12 fixtures



Cell | Downlights | 3 x powerLEDs 4W | Driver remote | 12W 350mA

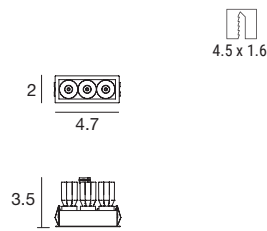

CRI 80

White	<b>E64509</b>	2700 K	1470 lm	<b>M</b>	Spot	<b>15</b>
Wh Bk	<b>E64510</b>	3000 K	1470 lm	<b>W</b>	Medium Flood	<b>30</b>
		3500 K	1470 lm	<b>T</b>	Flood	<b>45</b>
		4000 K	1587 lm	<b>N</b>		

Power supply options (remote only)

**ECO30W-350**

0-10V EldoLED ECOdrive  
30W  
for 1-2 fixtures

**SOLO50W-350**

0-10V EldoLED  
SOLOdrive 50W  
for 1-2 fixtures

**SOLO100W-350**

0-10V EldoLED  
SOLOdrive 100W  
for 1-4 fixtures



**E64542W30**

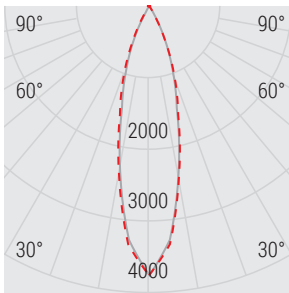

Photometric curve

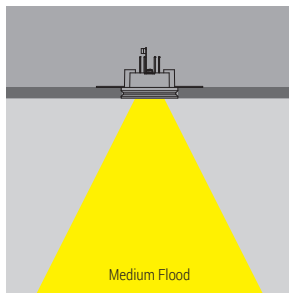

Light beam

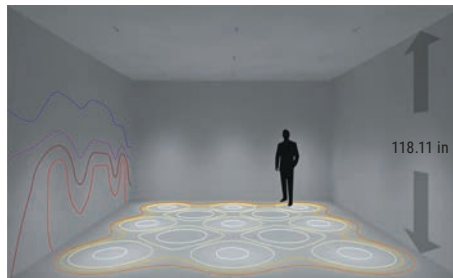

30 LUX 40 LUX 50 LUX 60 LUX 200 LUX 250 LUX 300 LUX 500 LUX

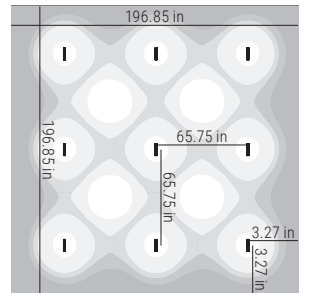

Floor plan

**E64545W15**

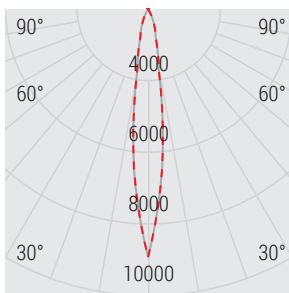

Photometric curve

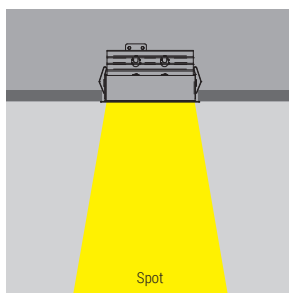

Light beam

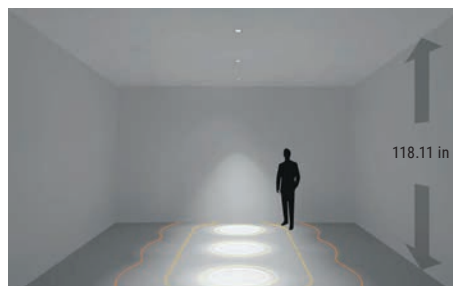

25 LUX 100 LUX 300 LUX 1000 LUX

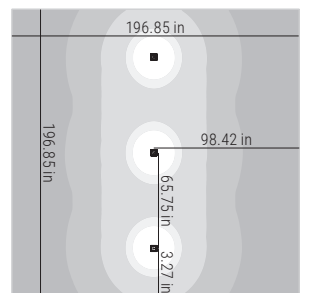

Floor plan