

whitegoods

Wand

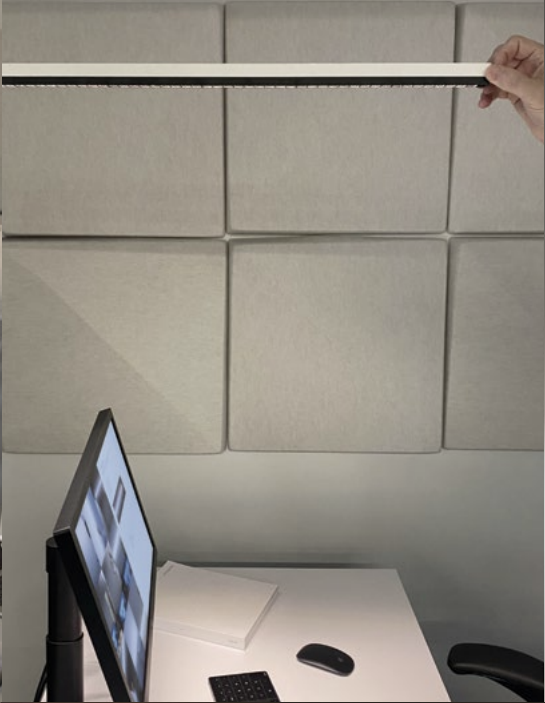

inter•lux



Introducing the Whitegoods Wand

We developed the Wand to allow specifiers to see for themselves just how flexible and multitalented the 20 Linear range really is.

Direct it up, down, vertically, horizontally, adjacent to a wall, the floor, a frosted panel or tuck it under a shelf. You'll soon find this is an indispensable tool for mocking up your ideas with light.

The Whitegoods Wand is provided with plenty of cable, a simple plug top driver, magnets to snap to metal surfaces, and multiple lens options.



Satin opal diffuser/
Satin clear diffuser



Linear narrow lens,
16 degree

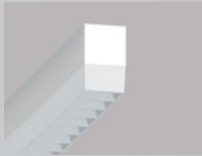

Linear louver



Round opal diffuser



General

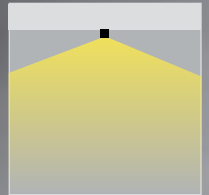

45° Cut Off

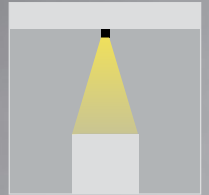

Narrow lens

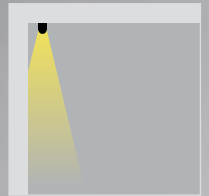

Concealed Uplight

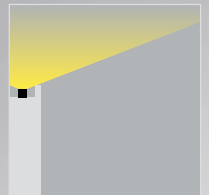

Cove

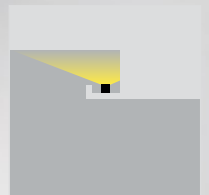

Floor Wash

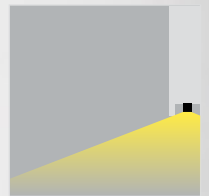

Ceiling Slot

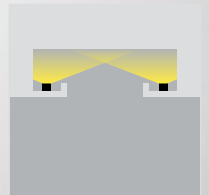

Wall Graze

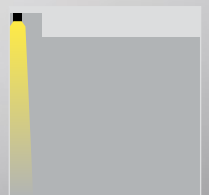

WAND 20 Linear



Luminaire

- Standard Opal Diffuser for even illumination and no LED appearance.
- Field replaceable LED boards.
- 90+ CRI, 3 steps MacAdam.
- White finish standard.
- On / Off switch with 118" cable and plug, standard.

Fixation

- MM = Magnetic mounting

Type

- S = Straight run

Length

- 29.5 = 29.5"

(Total length includes 1" for switch, requires 1" clearance for cable)

Power¹

- M = 6.4W/ft mid power (24V)

CRI/CCT²

90+ CRI (Mid Power)

- 930 = 3000K (359 lm/ft)
- 935 = 3500K (366 lm/ft)

Driver (remote)³

- S = Standard non-dim driver

Lens

- OD = Satin opal diffuser (standard)
- SD = Satin clear diffuser (high efficiency)
- NL16 = Linear narrow lens, 16 degree
- LL45W = Linear louver white
- LL45B = Linear louver black
- LL45CT = Linear louver clear translucent
- ROD = Round opal diffuser

Finish

- W = White, 20% gloss, RAL9010 (standard)

1 Wattage shown does not include power supplies/drivers.

2 Delivered lumens with opal diffuser shown.

3 24V fixture supplied complete with individual socket mount power supply 120-240V, 50-60 Hz and feed cable.

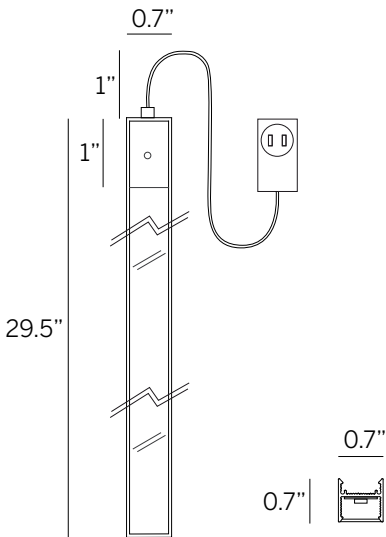

Ordering Information

Model	Fixation	Type	Length	Power ¹	CRI/CCT ²	Driver ³	Lens	Finish
WG-WAND	MM	S	29.5	M	930 935	S	OD (std) SD NL16 LL45W LL45B LL45CT ROD	W (std)