

100 Round Angled Gimbal 22 Specifications

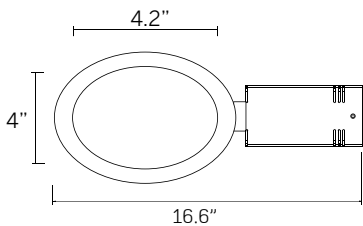
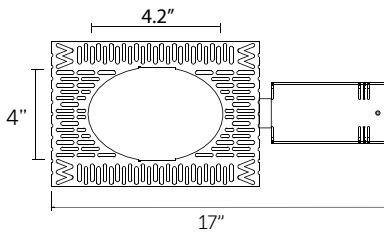
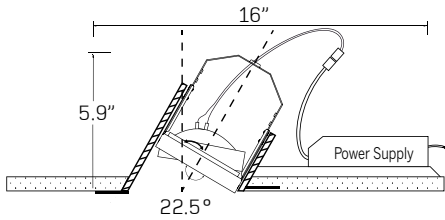

cut-out dimensions 4 5/8" x 5" oval

Ordering Information

Model	Lamp	Watts	Voltage	Power ¹	Diffuser
WG-P100RAG22 plaster-in	LVR low voltage halogen	20	120	DELV	AS CG FR MP
WG-B100RAG22 bezel	MR16 GU5.3		12	X no power supply (for magnetic order below)	

¹Specify remote power supply separately below.

Luminaire

- Bezel trim or trimless plaster-in 4" oval angled gimbal for drywall ceilings with 22.5° tilt.
- 30° adjustable lamp insert standard.
- Installation from below for remodel, new construction or outdoor under canopy.
- 'Easy click' installation of diecast aluminum lamp insert module.
- Die-cast aluminum trim housing with heavy gauge galvanized steel yoke with removable jbox from below ceiling.
- Tool free lamp and gear maintenance.
- Pre-wired with a 'Plug and Play' electrical connection.
- Open aperture standard, other diffusers available (see diffusers).
- Powdercoat painted white - RAL 9010.

Lamp

- LVR = low voltage halogen MR16 GU5.3 (open aperture compatible with LED MR16)

Watts

- 20 = 20W

Voltage

- 120 = 120V
- 12 = 12V load (MR16)

Diffuser (open aperture standard)

- AS = snoot
- CG = clear glass
- FR = frosted glass
- MP = micro prism glass

Power Supply²

DELV = Electronic low voltage remote driver 120V = 60W, class 2, dimmable (1 per fixture included)

Specify X above and order Magnetic low voltage dimmable transformers separately below

- T-540-10002 = 300W, 12VAC, 120V, class 2, 5 lamps, remote transformer³
- T-540-10017 = 300W, 12VAC, 277V, class 2, 5 lamps, remote transformer³
- T-540-10015 = 500W, 12VAC, 120V, class 2, 8 lamps, remote transformer⁴
- T-540-10014 = 500W, 12VAC, 277V, class 2, 8 lamps, remote transformer⁴

²See power supply pages for details. ³Up to 5 fixtures controlled per dimmer/switch.

⁴Up to 8 fixtures controlled per dimmer/switch.

100 Round Angled Gimbal 22 Dimensions

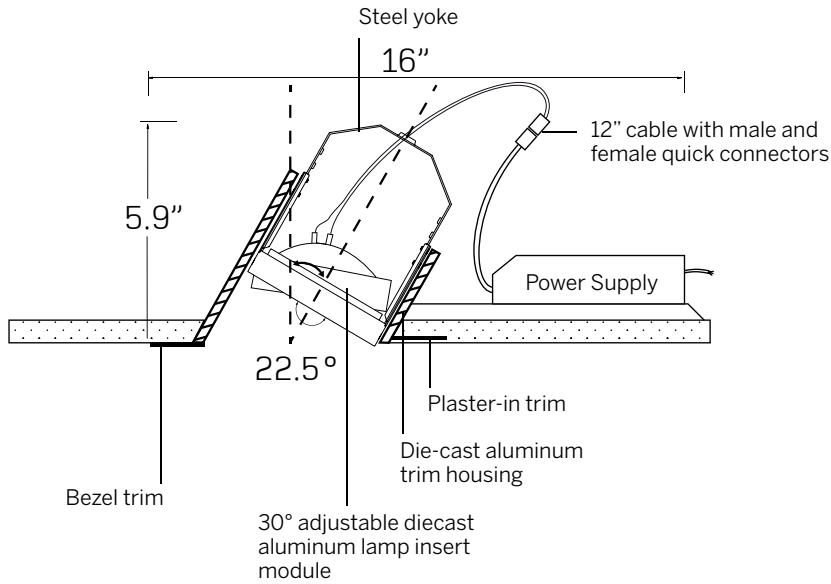

cut-out dimensions 4 5/8" x 5" oval
See power supply page for details.

Plaster-in instructions

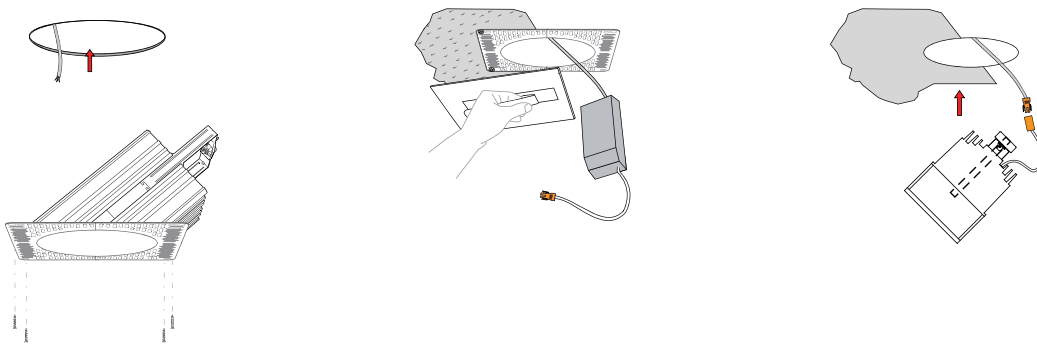

Bezel instructions

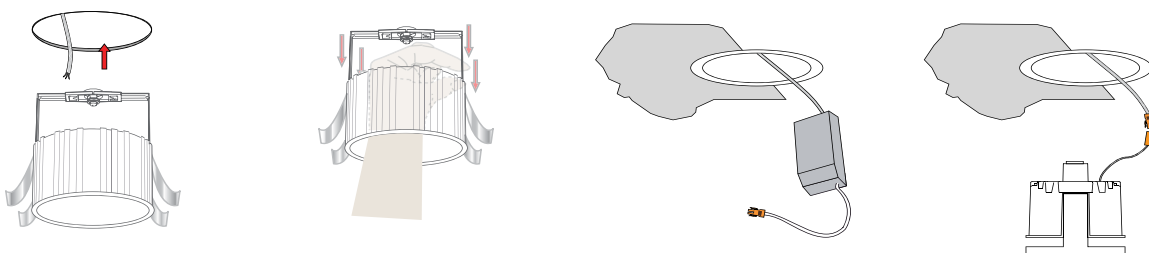

DELV (Electronic LV driver)

120V dimmable electronic low voltage driver.
 Class 2 driver, maximum distance 10'.
 Supplied with enclosure (shown right).

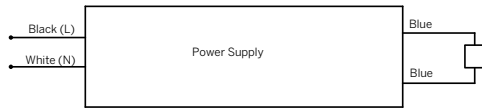

Magnetic LV transformer Class 2, UL 2108, fully dimmable

300W
 # T-540-10002 (120V)
 # T-540-10017 (277V)
 weight 10 lbs.

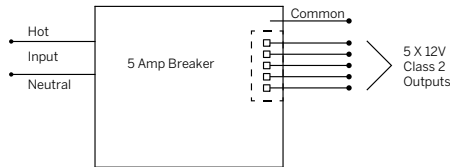

Enclosure

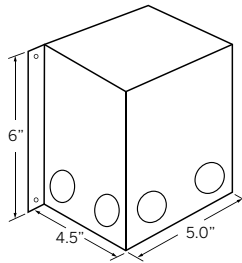

500W
 # T-540-10015 (120V)
 # T-540-10014 (277V)
 Weight 19 lbs.

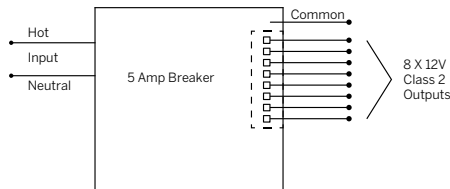

Enclosure

