

# 20 Linear Wash Light Recessed

## PATTERN INSIDE (PI)

Recessed Bezel Trim / Recessed Grid Trim

WG-20LWW-RBT/RGTx-PI-..

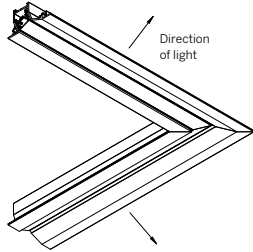

Minimum Angle 30°  
Maximum Angle 180°

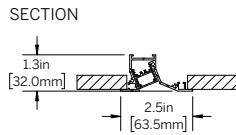

Direction of light →

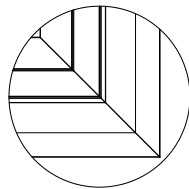

Mitered / Welded Housing  
Mitered Lens (OD, SD, MPL)

## PATTERN OUTSIDE (PO)

Recessed Bezel Trim / Recessed Grid Trim

WG-20LWW-RBT/RGTx-PO-..

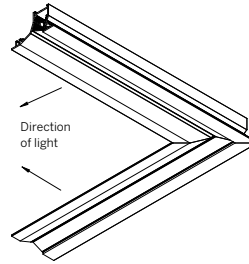

Minimum Angle 30°  
Maximum Angle 180°

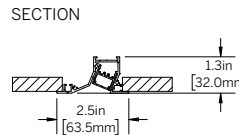

Direction of light ←

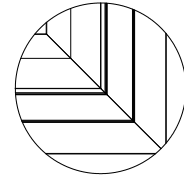

Mitered / Welded Housing  
Mitered Lens (OD, SD, MPL)

## PATTERN INSIDE (PI)

Recessed Plaster Trim

WG-20LWW-RPT-PI-..

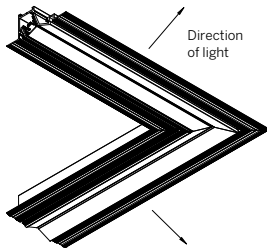

Minimum Angle 30°  
Maximum Angle 180°

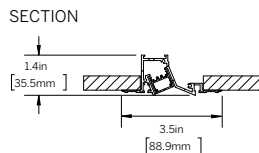

Direction of light →

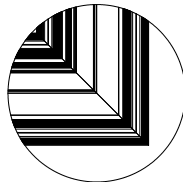

Mitered / Welded Housing  
Mitered Lens (OD, SD, MPL)

## PATTERN INSIDE (PO)

Recessed Plaster Trim

WG-20LWW-RPT-PO-..

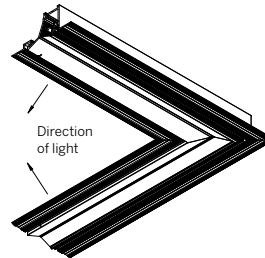

Minimum Angle 30°  
Maximum Angle 180°

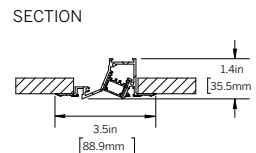

Direction of light ←

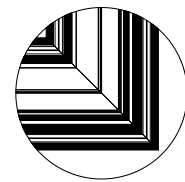

Mitered / Welded Housing  
Mitered Lens (OD, SD, MPL)

# 20 Linear Wash Light Recessed

## CORNER + STRAIGHT RUN CONNECTIONS

Recessed Bezel Trim

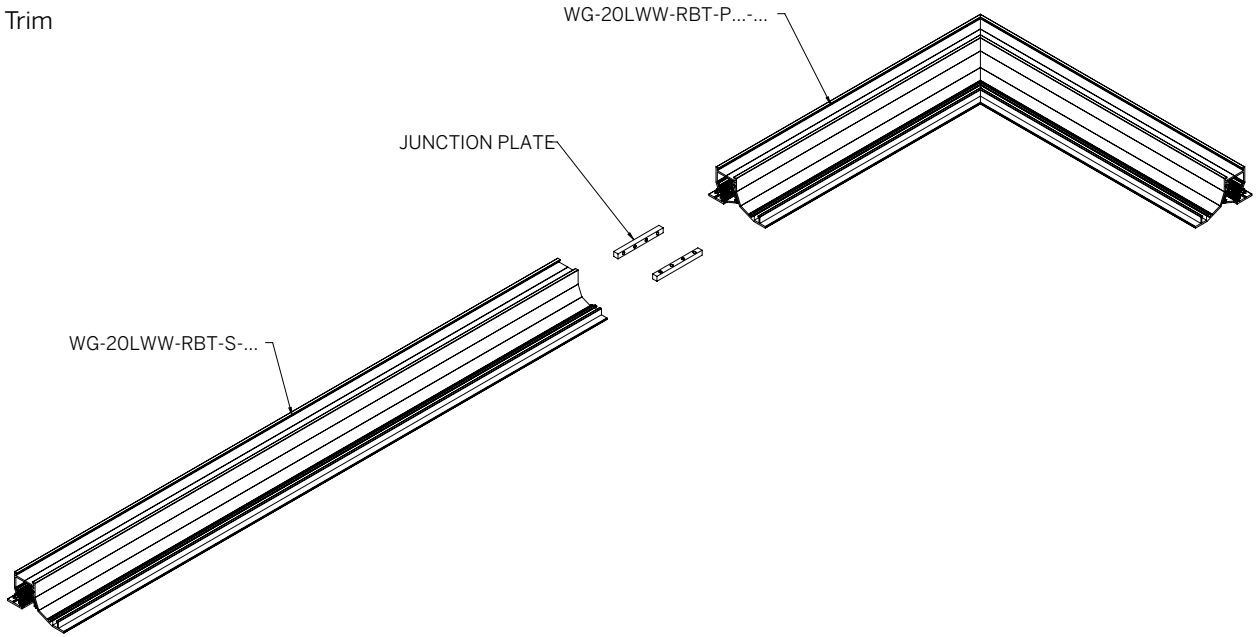

## CORNER + STRAIGHT RUN CONNECTIONS

Recessed Plaster Trim

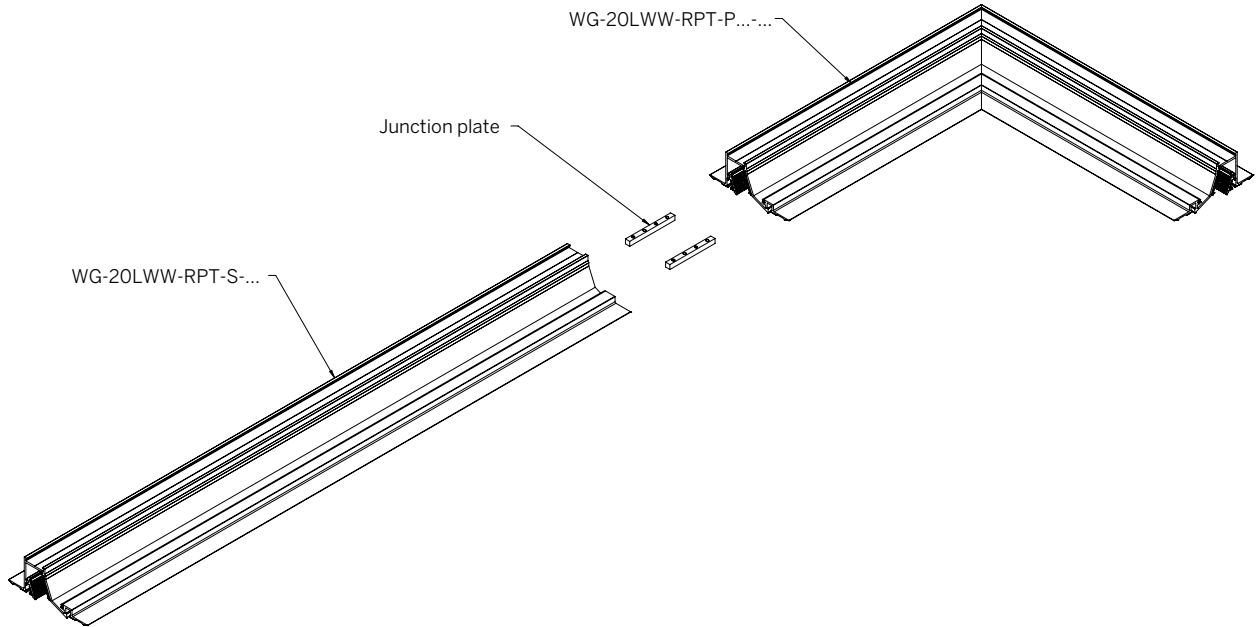

# 20 Linear Wash Light Recessed

## MOUNTING

Recessed Plaster Trim

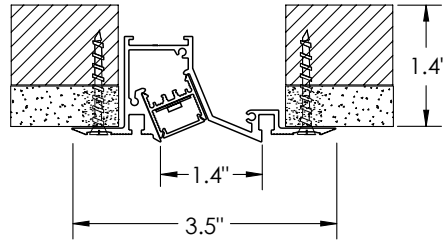

## BEZEL TRIM (HARD CEILING)

Recessed Bezel Trim (Hard Ceiling)

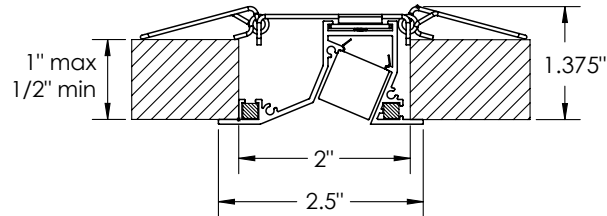

## GRID TRIM

Recessed Grid Trim

