

Coves + Perimeter - Integral Drivers

driver information

Please refer to driver manufacturer's website for current data sheets and wiring guidelines.

E1 = EldoLED 0.1% dimming, 0-10V (120-277V) [spec sheet](#) [30W](#) | [75W](#)

30W Wiring Diagram:



75W Wiring Diagram:

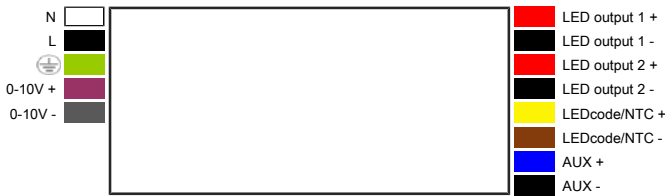

L1 = Lutron 1% dimming, Ecosystem (120-277V) [spec sheet](#)

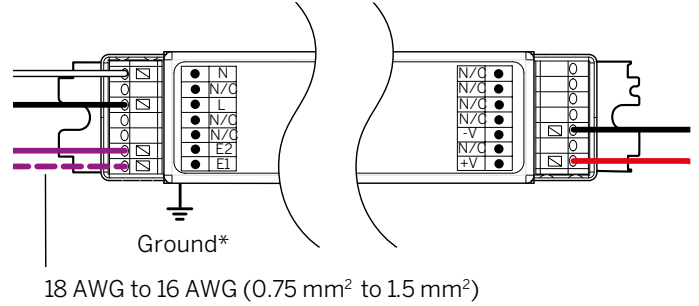

TQ = T-Series for Lutron Quantum 0.1% (120-277V) (Tunable White Only) [spec sheet](#)

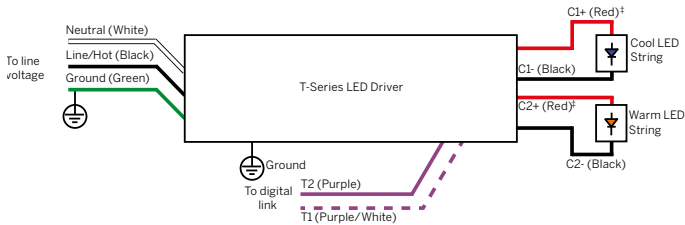

† C1+ and C2+ are electrically connected inside the driver. This supports the use of common anode loads.

DALI = EldoLED Dali DT8 0.1% (120-277V) [spec sheet](#)



BT = Wireless CAS – Casambi (Must be specified with E1 or DALI) [spec sheet](#)

BT + E1

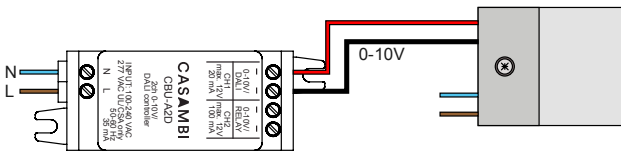

BT + DALI = TW

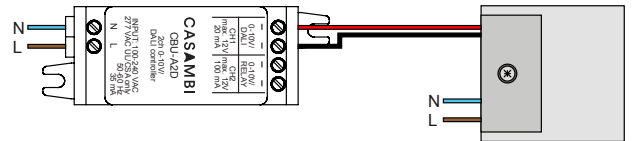

Coves + Perimeter - Integral Drivers

driver information

Please refer to driver manufacturer's website for current data sheets and wiring guidelines.

D010 - EldoLED, 10% 0-10V dimming, 120-277V [spec sheet](#)

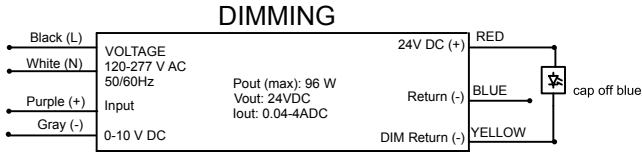

Warning: if not connected to a 0-10V dimmer, driver **MUST** be wired as Non-dim. Not doing so can cause the driver and the fixtures to fail prematurely.

Compatible/Recommended dimmers and interfaces*:

- Lutron Diva DVSTV (Wallbox dimmer)
- Lutron Nova T NTSTV (Wallbox dimmer)
- Lutron Maestro MS-Z101/MS-Z101-V (Wallbox dimmer/sensor)
- Lutron PowPak 0-10V RMJ-5T-DV-B (Energi Tripak)
- Lutron GRX-TVI (0-10V interface for Grafik QS and some commercial dimming panels)
- Lutron TVI-LMF-2A (EcoSystem to 0-10V interface)
- Lutron QSN-4T16-S (Energi Savr Node 0-10V)
- Lutron TVM2 module (HomeWorks and commercial dimming panels)

*Consult factory for any dimmer not listed

L3DAE = Lutron Hi-lume 1% EcoSystem, 120-277V [spec sheet](#)

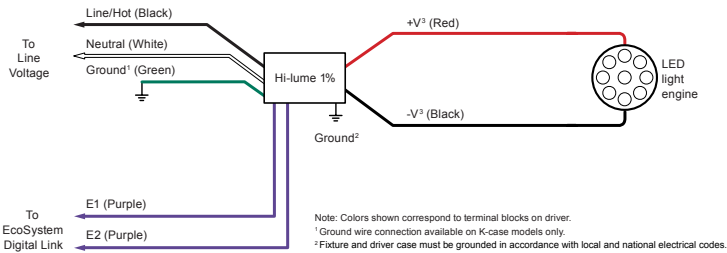

EcoSystem Controls			
Product	Model Number	Drivers per Control	Dimming
PowPak dimming module with EcoSystem	RMJ-ECO32-DV-B 3	32 per EcoSystem link	100%–1%
	FCJ-ECO, FCJS-ECO	3 per EcoSystem link ¹	100%–1%
Energi Savr Node with EcoSystem	2QSN-1ECO-S, QSN-2ECO-S	64 per EcoSystem link	100%–1%
GRAFIK Eye QS with EcoSystem	QSGRJ_E, QSGR_E	64 per EcoSystem link	100%–1%
Quantum	Various	64 per EcoSystem link	100%–1%

1 Up to 3 drivers controlled as a single zone (broadcast EcoSystem).

L3DOE = Lutron Hi-lume Premier 0.1% EcoSystem, 120-277V [spec sheet](#)

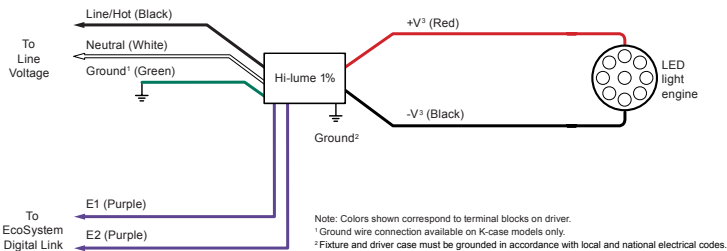

Drivers are programmed to Linear dimming curve by default.
 Compatible/Recommended dimmers and interfaces*:

- PowPak Dimming Module with EcoSystem
- Lutron Nova T NTSTV (Wallbox dimmer)
- Lutron Maestro MS-Z101/MS-Z101-V (Wallbox dimmer/sensor)
- Lutron PowPak 0-10V RMJ-5T-DV-B (Energi Tripak)
- Lutron GRX-TVI (0-10V interface for Grafik QS and some commercial dimming panels)
- Lutron TVI-LMF-2A (EcoSystem to 0-10V interface)
- Lutron QSN-4T16-S (Energi Savr Node 0-10V)
- Lutron TVM2 module (HomeWorks and commercial dimming panels)

*Consult factory for any dimmer not listed

Dry Location Enclosure

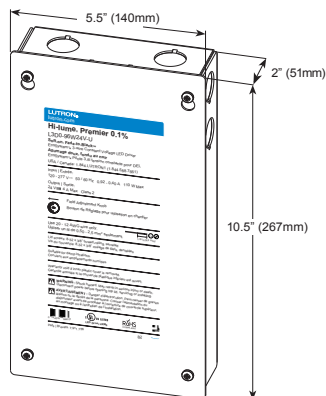

Wire gauge*	Maximum wiring distance*
24 AWG (0.20 mm ²) ³	6 ft (1.8 m)
22 AWG (0.34 mm ²) ³	10 ft (3.0 m)
20 AWG (0.50 mm ²)	15 ft (4.5 m)
18 AWG (0.75 mm ²)	25 ft (7.62 m)
16 AWG (1.0 mm ²)	40 ft (12.2 m)
14 AWG (1.5 mm ²)	60 ft (18.3 m)
12 AWG (2.5 mm ²)	100 ft (30.5 m)
10 AWG (4.0 mm ²) ³	150 ft (45.7 m)

1 To use wire gauges larger or smaller than terminal blocks' rated gauge of 20 AWG to 12 AWG (0.50 mm² to 2.50 mm²), connect 12 in (30 cm) or less of rated wire from terminal and connect with larger or smaller wire.

Coves + Perimeter - Integral Drivers

driver information

EL96 = Osram / EidoLED, 24V, 1% 0-10V Dimming [Driver spec sheet](#) | [0-10V interface](#)

Compatible/Recommended dimmers and interfaces*:

- Lutron Diva DVSTV (Wallbox dimmer)
- Lutron Nova T NTSTV (Wallbox dimmer)
- Lutron Maestro MS-Z101/MS-Z101-V (Wallbox dimmer/sensor)
- Lutron PowPak 0-10V RMJ-5T-DV-B (Energi Tripak)
- Lutron GRX-TVI (0-10V interface for Grafik QS and some commercial dimming panels)
- Lutron TVI-LMF-2A (EcoSystem to 0-10V interface)
- Lutron QSN-4T16-S (Energi Savr Node 0-10V)
- Lutron TVM2 module (HomeWorks and commercial dimming panels)

*Consult factory for any dimmer not listed

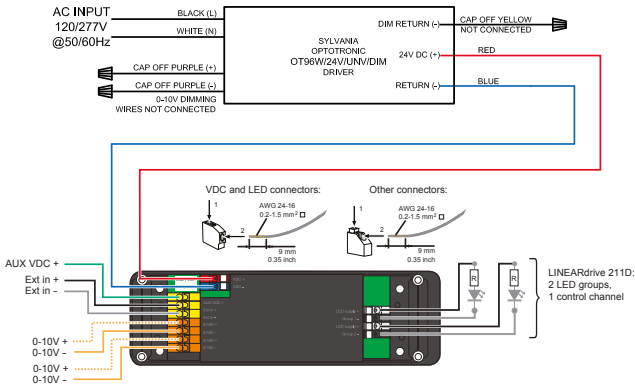

DMX = Osram / EidoLED, 24V, 0.1% DMX Dimming [Driver spec sheet](#) | [DMX interface](#)

