

# 60 Square Wall Wash IP LED

## Specifications

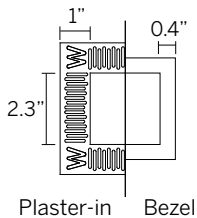
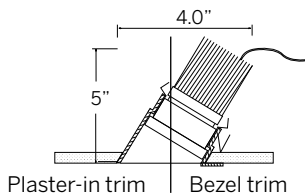

cut-out dimensions 2 3/4" x 2 3/4"

### Ordering Information

Model	LED <sup>1,2</sup>	Power <sup>3</sup>	Beam Angle	Voltage	Power Supply <sup>4</sup>	Diffuser
WG-P60SWWIP plaster-in	<b>80 CRI</b> CB-827 CB-830	L M H	30 40 80	UNV	X S D010 D3W <sup>5</sup> DES <sup>5</sup>	CD FR (80° Beam Only) MP
WG-B60SWWIP bezel trim	<b>90 CRI</b> CB-927 CB-930 CB-935 CB-940					
	<b>95 CRI</b> CB-F927 CB-F930 CB-F935 CB-F940			120	DFPN <sup>5</sup>	

#### Luminaire

- Bezel trim or trimless 'plaster-in' 2.4" square Wall Wash (20° tilt) for drywall ceilings and tiles.
- IP65 rated, wet location (suitable for shower).
- Installation from below the ceiling for remodel or new construction.
- Die-cast aluminum LED insert with retaining springs and gasket.
- Tool free lamp maintenance.
- Frosted regressed diffuser standard, other diffusers available (see diffusers).
- Powder coat painted white - RAL 9010.

#### LED<sup>1,2</sup>

80+ CRI (Low/Medium/High Power)

- CB-827 = 2700K, 1045/1233/1540lm
- CB-830 = 3000K, 1045/1233/1540lm
- CB-835 = 3500K, 1091/1311/1698lm
- CB-840 = 4000K, 1091/1311/1698lm
- For 90+ CRI specify, CB-927, CB-930, etc. Approximately 15% less lumens than 80 CRI.
- For 95+ CRI specify, CB-F927, CB-F930, etc. Approximately 30% less lumens than 80 CRI.

#### Power<sup>3</sup>

- L = Low Power, 6.8W @ 400mA
- M = Mid Power, 8.6W @ 500mA
- H = High Power, 12.4W @ 700mA

#### Beam Angle

- 30 = 30° accent illumination
- 40 = 40° general illumination
- 80 = 80° general illumination

#### Voltage

- UNV = 120-277V
- 120 = 120V

#### Power Supply (remote)<sup>4</sup>

- X = No driver.
- S = Standard non-dim driver, 120-277V.
- D010 = EldoLED, 1%, 0-10V dimming, 120-277V.
- D3W = Lutron, 1%, 3-wire dimming, 120V-277V.<sup>5</sup>
- DES = Lutron, 1%, EcoSystem E1/E2 digital dimming, 120-277V.<sup>5</sup>
- DFPN = Lutron 1% forward phase with neutral, 120V only.<sup>5</sup>

#### Diffuser (frosted diffuser standard)

- CD = Regressed Clear Diffuser
- FR = Regressed Frosted Diffuser (80° Beam Only)
- MP = Regressed Micro Prismatic Diffuser

#### Emergency

- Emergency LED driver available, order separately.

#### Options

- CP = Chicago Plenum Housing available, refer to specsheet.
- IC = Insulated Ceiling Housing available, refer to specsheet.
- NC = New Construction Plates available, consult factory.

<sup>1</sup> Other lumen packages available, consult factory.

<sup>2</sup> See LED data sheet for delivered lumens.

<sup>3</sup> Wattage shown does not include power supplies/drivers. System wattage adds 10-20%.

<sup>4</sup> See power supply page for details.

<sup>5</sup> Consult factory for lead-times.



# 60 Square Wall Wash IP LED

## Dimensions

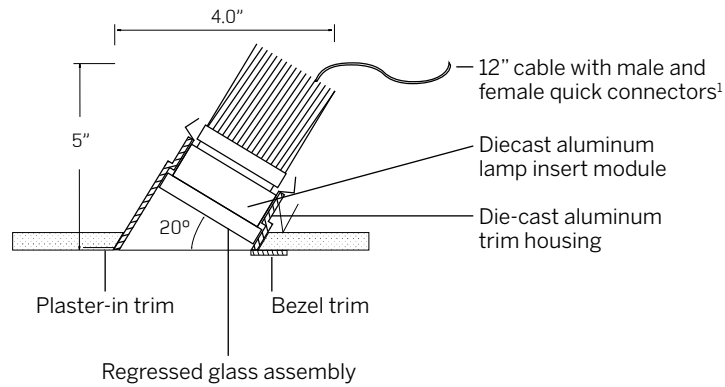

<sup>1</sup>Connectors included. Class II low voltage wire supplied by others. See power supply page for details.

### Plaster-in instructions

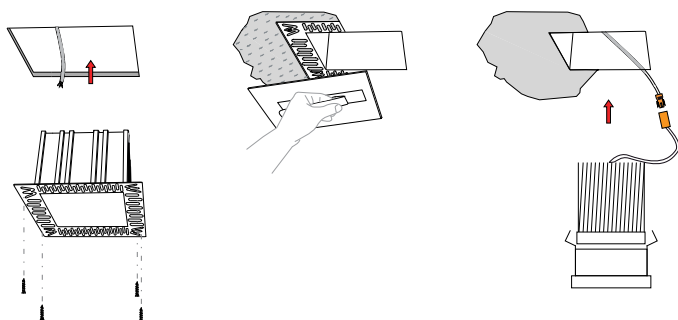

### Bezel instructions

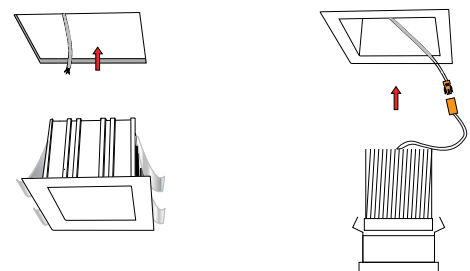

# 60 Square Wall Wash IP LED Power Supplies

S (Standard non-dim)

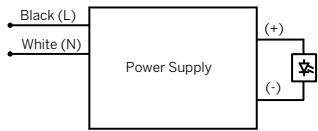

D010 (EldoLED 0-10V)

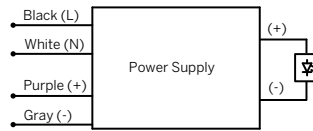

DFPN (Lutron forward phase with neutral)

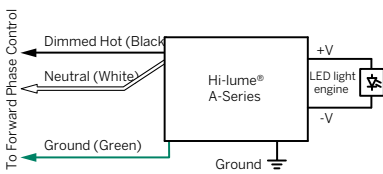

Note: Colors shown correspond to terminal blocks on driver.

DW3 (Lutron 1%, 3-wire)

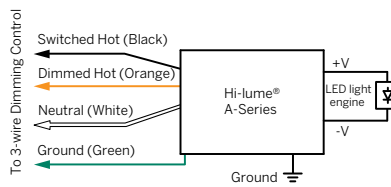

DES (Lutron EcoSystem® digital)

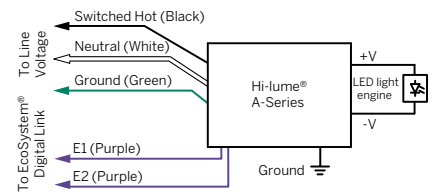

Note: Colors shown correspond to terminal blocks on driver.

Note: Colors shown correspond to terminal blocks on driver.